

# VIASYS<sup>®</sup>

HEALTHCARE

*Excellence For Life*



## LTV<sup>®</sup> 1200 Ventilator

### *Operator's Manual*

P/N 18247-001, Rev. B

May 2006

## Document Revision History

Document Revision Level	Revision Date
Rev A, ECO 3891	April 2006
Rev B, ECO 4016	May 2006

---

### ***Contact Information***

#### **Pulmonetic Systems, Inc.**

17400 Medina Rd., Suite 100

Minneapolis, Minnesota 55447-1341

Phone: (763) 398-8300

Customer Care Center: (800) 754-1914

Fax: (763) 398-8400

E-mail: [info@pulmonetic.com](mailto:info@pulmonetic.com)

Website: <http://www.pulmonetic.com>

LTV<sup>®</sup> 1200 is a trademark belonging to Pulmonetic Systems, Inc.

Copyright © 2006 Pulmonetic Systems, Inc., Minneapolis, Minnesota.

## *Warranty*

---

Pulmonetic Systems warrants that the LTV<sup>®</sup> 1200 ventilator is free from defects in material and workmanship for a period of one (1) year from the date of shipment, or 8,800 hours as measured on the usage meter, whichever comes first, with the following limitations:

1) The internal battery is warranted for ninety (90) days from date of shipment.

Pulmonetic Systems will, at its option, either repair, replace, or issue credit for products that prove to be defective during the warranty period.

For warranty service or repair, the product must be returned to Pulmonetic Systems or a service facility designated by Pulmonetic Systems, shipping prepaid by the Buyer.

### **LIMITATION OF WARRANTY**

Ordinary maintenance, as specified in the LTV<sup>®</sup> 1200 Ventilator Operator's and Service Manuals, is not covered under the forgoing warranty.

The forgoing warranty does not apply to defects or damage to the unit resulting from:

- Improper use or misuse
- Improper or inadequate maintenance
- Unauthorized modifications or repairs
- Use of the unit with unauthorized accessories, e.g. external battery or AC adapter
- Use or storage outside the specified environment

### **NO IMPLIED WARRANTIES**

This warranty is exclusive. There are no other warranties expressed or implied.

### **LIMITATION OF LIABILITY**

Pulmonetic Systems shall not be liable for loss of profits, loss of use, consequential damages, or any other claim based on breach of warranty. Pulmonetic Systems, Inc.'s liability for damages of any kind shall be limited to the purchase price of the defective unit.

## *Notices*

---

The LTV<sup>®</sup> 1200 ventilator complies with limitations as specified in IEC 601-1-2 for Medical Products. It does however, use and radiate radio frequency energy.

The function of this machine may be adversely affected by the operation of other nearby equipment, such as high frequency surgical diathermy equipment, short-wave therapy equipment, defibrillators or MRI equipment.



FM 75092  
CE 02342

---

### *European Regulatory Requirements per 93/42/EEC Medical Device Directives*

Pulmonetic Systems, Inc.'s European Representative for vigilance reporting within the European Community is:

**MediMark® Europe Sarl.**

11, rue Emile Zola. BP 2332  
F-38033 Grenoble Cedex 2. France  
Tel: +33 (0)4 76 86 43 22  
Fax: +33 (0)4 76 17 19 82  
E-mail: [info@medimark-europe.com](mailto:info@medimark-europe.com)

Any product malfunctioning issues that fall under Medical Device Directives Essential Requirements should be directed to MediMark.

## **Notice To Operators**

**Unsafe Operation** - Operating the LTV<sup>®</sup> 1200 ventilator without a complete and thorough understanding of its attributes is unsafe and may cause harm to the patient. It is important that this manual be read and understood in its entirety before operating the ventilator.

**Warnings and Cautions Section** - Read the section on **Warnings** and **Cautions** carefully before operating the LTV<sup>®</sup> 1200 ventilator.

**Use and Maintenance** - Any questions regarding installing, operating, or maintaining the LTV<sup>®</sup> 1200 ventilator, should be directed to a certified Pulmonetic Systems' service technician or Pulmonetic Systems, Inc.

## **Avis important**

**Fonctionnement dangereux** - L'opération d'un ventilateur de la LTV<sup>®</sup> 1200 sans une excellente compréhension de ses attributs est dangereuse et risque de blesser le patient. Il est très important de lire et de comprendre entièrement ce manuel avant de faire fonctionner le ventilateur.

**Section Avertissements et Attention** - Lire attentivement la section **Avertissements** et **Attention** avant de procéder à l'opération des ventilateurs de la LTV<sup>®</sup> 1200.

**Utilisation et entretien** - En cas de questions concernant l'installation, l'opération ou l'entretien des ventilateurs de la série LTV<sup>®</sup>, veuillez vous adresser à un technicien de service certifié de Pulmonetic Systems ou directement à Pulmonetic Systems, Inc.

# Contents

Warranty .....	ii
Notices .....	iii
<b>Chapter 1 - Introduction .....</b>	<b>1-1</b>
Operator's Safety Information .....	1-2
Warnings .....	1-3
Cautions .....	1-11
Symbols .....	1-17
<b>Chapter 2 - Ventilator Overview .....</b>	<b>2-1</b>
Intended Use .....	2-1
Power/Supplies Required .....	2-2
Information/Assistance .....	2-3
<b>Chapter 3 - Breath Types .....</b>	<b>3-1</b>
Breath Types .....	3-1
Volume Control Breaths .....	3-2
Pressure Control Breaths .....	3-3
Pressure Support Breaths .....	3-5
Spontaneous Breaths .....	3-6
<b>Chapter 4 - Ventilation Modes .....</b>	<b>4-1</b>
Control Mode .....	4-1
Assist/Control Mode .....	4-1
SIMV Mode .....	4-2
CPAP Mode .....	4-3
NPPV Mode .....	4-4
Apnea Backup .....	4-5
Volume Pressure Ventilation .....	4-6
Bias Flow .....	4-6
<b>Chapter 5 - Using the Controls and Indicators .....</b>	<b>5-1</b>
Ventilator Controls .....	5-1
Setting a Control .....	5-2
Variable Controls .....	5-2
Buttons .....	5-3
Set Value Knob .....	5-3
Extended Features .....	5-3
Bright, Dim and Blank Control Displays .....	5-4
Flashing Controls .....	5-5
Dashes .....	5-5
Control Limiting .....	5-5
Control Locking .....	5-6
Control Retention .....	5-6

<b>Chapter 6 - Controls</b> .....	<b>6-1</b>
Assist/Control - SIMV/CPAP - NPPV .....	6-1
Breath Rate .....	6-2
Control Lock .....	6-3
High Pressure Limit.....	6-4
Inspiratory / Expiratory Hold.....	6-5
Inspiratory Hold.....	6-6
Expiratory Hold .....	6-8
Inspiratory Time.....	6-10
Low Minute Volume.....	6-11
Low Pressure .....	6-12
Low Pressure O <sub>2</sub> Source.....	6-13
Manual Breath .....	6-17
O <sub>2</sub> % (O <sub>2</sub> Flush).....	6-18
On/Standby .....	6-20
PEEP Control .....	6-21
PEEP Control in NPPV Mode .....	6-21
Pressure Control .....	6-22
Pressure Support .....	6-23
Pressure Support in NPPV Mode .....	6-23
Select .....	6-24
Sensitivity .....	6-25
Set Value Knob .....	6-26
Silence Reset .....	6-27
Tidal Volume .....	6-28
Volume Pressure Mode.....	6-29
 <b>Chapter 7 - Displays and Indicators</b> .....	 <b>7-1</b>
Airway Pressure .....	7-1
Display Window.....	7-1
Indicators.....	7-1
Battery Level .....	7-2
Charge Status .....	7-4
External Power .....	7-5
NPPV.....	7-6
Patient Effort.....	7-6
Vent Inop.....	7-6
 <b>Chapter 8 - Monitored Data</b> .....	 <b>8-1</b>
Automatic or Manual Data Display Scrolling.....	8-2
PIP xxx cmH <sub>2</sub> O.....	8-3
MAP xx cmH <sub>2</sub> O .....	8-3
PEEP xx cmH <sub>2</sub> O.....	8-3
f xxx bpm.....	8-3
Vte xxx ml .....	8-3
VE xx.x L.....	8-3

I:E xx:xx .....	8-3
I:Ecalc xx:xx .....	8-4
Vcalc xxx Lpm .....	8-4
SBT xxx min .....	8-4
xxx f/Vt xx f .....	8-4

**Chapter 9 - Ventilator Alarms..... 9-1**

Alarms.....	9-2
APNEA, APNEA xx bpm .....	9-2
BAT EMPTY .....	9-3
BAT LOW .....	9-5
DEFAULTS.....	9-7
DEFAULTS SET.....	9-9
DISC/SENSE.....	9-10
HIGH f.....	9-11
HIGH O <sub>2</sub> PRES.....	9-12
HIGH PEEP .....	9-13
HIGH PRES.....	9-14
HW FAULT .....	9-16
INOP.....	9-17
LOW MIN VOL .....	9-18
LOW O <sub>2</sub> PRES.....	9-19
LOW PEEP.....	9-20
LOW PRES .....	9-21
NO CAL DATA, NO CAL Monitor Display .....	9-22
POWER LOST .....	9-23
POWER LOW.....	9-24
REMOVE PTNT .....	9-25
RESET.....	9-26
SBT < f .....	9-27
SBT > f .....	9-28
SBT < f/Vt .....	9-29
SBT > f/Vt.....	9-30
SBT OFF .....	9-31
XDCR FAULT .....	9-32
Alarm Status Messages.....	9-33
f PEEP OFF.....	9-33
HI f/Vt OFF .....	9-33
HI PEEP OFF .....	9-33
H&L PEEP OFF.....	9-34
HIGH f OFF .....	9-34
LMV LPPS OFF.....	9-34
LMV OFF.....	9-35
LO PEEP OFF .....	9-35
LOCKED.....	9-35
LO f/Vt OFF .....	9-36



LPPS OFF .....	9-36
SBT f OFF .....	9-36
SBT f/Vt OFF .....	9-37
SBT HI f OFF .....	9-37
SBT LO f OFF .....	9-37
SBT TIME .....	9-38
WARMUP xx .....	9-38

**Chapter 10 - Extended Features.....10-1**

Navigating the Extended Features Menus .....	10-2
Alarm Operations .....	10-3
Alarm Volume .....	10-3
Apnea Interval .....	10-4
High Pressure Alarm Delay .....	10-4
Low Peak Pressure Alarm .....	10-4
High f.....	10-5
High PEEP .....	10-5
Low PEEP .....	10-5
Patient Assist .....	10-6
Exit .....	10-6
Vent Operations .....	10-7
Variable Rise Time.....	10-8
Variable Flow Termination .....	10-9
Variable Time Termination.....	10-10
Pressure Control Flow Termination .....	10-11
Leak Compensation .....	10-12
O <sub>2</sub> Flush .....	10-13
Control Unlock .....	10-14
Language Selection .....	10-14
Software Version.....	10-15
Usage Meter .....	10-15
Communications Setting.....	10-15
Set Date .....	10-16
Set Time.....	10-17
Date Format .....	10-17
PIP LED .....	10-18
Model Number / Serial Number .....	10-18
Valve Home Position .....	10-19
Set Defaults .....	10-19
O <sub>2</sub> Cylinder Duration .....	10-20
Presets .....	10-22
Turning Patient Query on or off .....	10-22
Selecting Patient Size .....	10-22
LTV <sup>®</sup> 1200 Presets Table .....	10-23
SBT (Spontaneous Breathing Trial) Operations .....	10-24
SBT Alarms .....	10-26

Transducer Autozero .....	10-27
Airway Pressure Transducer Autozero .....	10-27
Bi-directional Flow Transducer Differential Autozero .....	10-28
Exhalation Flow Transducer Differential Autozero - Narrow .....	10-29
Exhalation Flow Transducer Differential Autozero - Wide .....	10-30
Real Time Transducers .....	10-31
<b>Chapter 11 - Ventilator Checkout Tests .....</b>	<b>11-1</b>
Alarm Test .....	11-3
Display Test .....	11-4
Control Test .....	11-6
Leak Test .....	11-8
Vent Inop Alarm Test .....	11-10
Exit .....	11-12
<b>Chapter 12 - Operating Procedure.....</b>	<b>12-1</b>
To Turn the Ventilator On .....	12-1
Before Connecting the Ventilator to a Patient .....	12-2
Procedure for Control Mode Set Up .....	12-4
Procedure for Assist/Control Mode Set Up.....	12-5
Procedure for SIMV Mode Set Up .....	12-6
Procedure for CPAP Mode Set Up .....	12-7
Procedure for NPPV Mode Set Up .....	12-8
To Turn the Ventilator Off .....	12-9
LTV® Ventilator Settings Checklist.....	12-10
<b>Chapter 13 - Cleaning, Disinfecting and Sterilizing .....</b>	<b>13-1</b>
Cleaning the Ventilator .....	13-1
Cleaning or replacing the Fan Filter .....	13-2
Cleaning or replacing the Inlet Filter .....	13-3
Cleaning or Replacing the O <sub>2</sub> Inlet Filter .....	13-4
Cleaning the Exhalation Valve and Reusable Patient Circuit.....	13-6
<b>Chapter 14 - Power and Battery Operation .....</b>	<b>14-1</b>
Using the AC Adapter .....	14-2
Using an External Battery .....	14-3
Using the Automobile Cigarette Lighter Adapter .....	14-6
Replacing the Automobile Adapter Fuse.....	14-10
The Universal Power Supply (UPS) .....	14-10
The Transport Battery System (TBS) .....	14-10
Caring for the Internal Battery .....	14-11
Battery Replacement.....	14-11
Battery Disposal .....	14-11
<b>Chapter 15 - Troubleshooting.....</b>	<b>15-1</b>
Displays and Buttons .....	15-2

Ventilator Performance .....	15-6
Power and Battery Operation.....	15-15
Alarms .....	15-17
Checkout Test Failures .....	15-23
Test Lung Operations.....	15-25
<b>Appendix A - Ventilator Specifications .....</b>	<b>A-1</b>
<b>Appendix B - Set Up / Maintenance .....</b>	<b>B-1</b>
Recommended Maintenance Schedule .....	B-1
Service Assistance.....	B-2
<b>Appendix C - Installation and Checkout.....</b>	<b>C-1</b>
Installation and Setup.....	C-1
Unpacking the Ventilator – Instructions .....	C-1
Protective Boots.....	C-2
Protective Boot Removal .....	C-3
Protective Boot Installation .....	C-6
Patient Breathing Circuit – Connection Instructions .....	C-10
Oxygen Lines – Connection Instructions .....	C-12
Patient Assist Call System – Connection Instructions .....	C-14
Communications Port .....	C-15
LTM™ Graphics Monitor.....	C-15
Using the Remote Alarm Cable .....	C-16
Checking the Ventilator for Proper Operation .....	C-18
Ventilator Proper Operation Worksheet.....	C-20
<b>Appendix D - Principles of Operation.....</b>	<b>D-1</b>
Overview .....	D-1
<b>Appendix E - Event Trace .....</b>	<b>E-1</b>
Event Codes.....	E-3
Event Codes by Code #.....	E-3
Event Codes by Event Name.....	E-6
<b>Appendix F - Glossary .....</b>	<b>F-1</b>
<b>Appendix G - Index.....</b>	<b>G-1</b>

## *Chapter 1 - INTRODUCTION*

This Operator's Manual contains detailed information and instructions which when adhered to, ensure the safe and effective set up, use and simple maintenance of the LTV<sup>®</sup> 1200 ventilator.

It is designed for use by Respiratory Therapists or other qualified and trained personnel under the direction of a physician and in accordance with applicable state laws and regulations. It contains the following:

- Ventilator Overview
- Installation and Checkout
- Using the Controls and Indicators
- Monitored Data
- Ventilator Alarms
- Extended Features
- Ventilator Checkout tests
- Operating Procedure
- Troubleshooting
- Cleaning, Disinfecting and Sterilizing
- Set Up / Maintenance
- Power and Battery Operation

Service tests, calibration, and major maintenance operations are described in the LTV<sup>®</sup> Series Ventilator's Service Manual (P/N 10665).

### **NOTE**

Pressure Support and Pressure Control breaths on the LTV<sup>®</sup> 1200 are compensated for PEEP. Delivered pressure is controlled by the Pressure Support or Pressure Control setting and is affected by the PEEP setting. For example, a Pressure Support setting of 20cmH<sub>2</sub>O and a PEEP setting of 10cmH<sub>2</sub>O results in a Peak Inspiratory Pressure (PIP) of 30cmH<sub>2</sub>O.

### **REMARQUE**

La pression de support et le contrôle de la pression des respirations sur le LTV<sup>®</sup> 1200 sont compensés pour la pression expiratoire positive (PEP). La pression administrée est contrôlée par le réglage de la pression de support ou par le réglage du contrôle de la pression et elle dépend du réglage PEP. Par exemple, un réglage de la pression de support de 20 cmH<sub>2</sub>O et un réglage PEP de 10 cmH<sub>2</sub>O donnent une pression inspiratoire maximale (PI<sub>max</sub>) de 30 cmH<sub>2</sub>O.

## *Operator's Safety Information*

---

All Operators are to read and understand the following information about **Warning**, **Caution** and **Note** statements before operating the LTV<sup>®</sup> 1200 ventilator.

### **WARNING**

“**WARNING**” statements alert the reader to potentially hazardous situations which, if not avoided, could result in death or serious injury.

### **AVERTISSEMENT**

Les énoncés « **AVERTISSEMENT** » informent le lecteur de situations dangereuses qui, si elles ne sont pas évitées, peuvent entraîner la mort ou des blessures graves.

### **CAUTION**

“**CAUTION**” statements alert the reader to potentially hazardous situations which, if not avoided, could result in equipment damage.

### **ATTENTION**

Les énoncés « **ATTENTION** » informent le lecteur de situations dangereuses qui, si elles ne sont pas évitées, peuvent causer des dommages à l'équipement.

### **NOTE**

“**NOTE**” statements contain additional information to assist in the proper operation of the LTV<sup>®</sup> 1200 ventilator.

### **REMARQUE**

Les énoncés « **REMARQUE** » contiennent des informations supplémentaires pour aider à l'opération adéquate des ventilateurs de la LTV<sup>®</sup> 1200.

### **WARNING**

**Untrained Personnel** – Only properly trained personnel should operate the ventilator. The LTV<sup>®</sup> 1200 ventilator is a restricted medical device designed for use by Respiratory Therapists or other properly trained and qualified personnel under the direction of a physician and in accordance with applicable state laws and regulations.

**Leak Testing the Patient Breathing Circuit** – The patient circuit must be leak tested in the **VENT CHECK** mode before connection to the patient. In addition, the Ventilator Checkout mode should be used to check for correct operation of the ventilator alarm, displays and controls. Harm to the patient or ineffective ventilation may result from failure to leak test the patient breathing circuit before connection to a patient. When using a heated humidifier, include it in the circuit when performing leak testing.

**Adjustable and Critical Alarms** – For safety purposes, all adjustable alarms and all critical alarms must be checked to insure proper operation.

**Alarms Function Verification** - All alarms must be verified as functioning properly on a daily basis. If any alarm malfunctions, immediately contact a certified Pulmonetic Systems' service technician or Pulmonetic Systems, Inc.

**Patient Monitoring** - Patients who are dependent on a ventilator should be constantly monitored by qualified personnel. Such personnel should be prepared to address equipment malfunctions and circumstances where equipment becomes inoperative. An alternative method of ventilation should be available for all patients dependent on the ventilator, and qualified personnel should be fully familiar with emergency ventilation procedures.

**Alternative Ventilation** - It is recommended that an alternative means of ventilating the patient be available at all times and that all ventilator operators be fully familiar with emergency ventilation procedures.

**Fire or Explosion** - Operation of the LTV<sup>®</sup> 1200 ventilator in the presence of flammable gases could cause a fire or explosion. Under no circumstances is the ventilator to be operated when explosive gases are present. The presence of nitrous oxide or flammable anesthetics presents a danger to the patient and operator.

**Patient Breathing Circuit Disconnection** - Inadvertent disconnection of the patient from the patient breathing circuit can be dangerous.

**Critical Alarms** - Failure to set the critical alarms such as the Low Minute Volume alarm and the Low Pressure alarm may cause non-detection (no alarm) for a disconnection of the lower sense line or the exhalation valve drive line.

**Exhalation Valve Diaphragm** – Patient ventilation may be ineffective or dangerous if the exhalation valve diaphragm is damaged or worn out. The exhalation valve diaphragm must be inspected on a daily basis and replaced whenever necessary.

**Sustained HIGH PRES Alarm** - During a sustained High Pressure alarm condition (**HIGH PRES**), the ventilator's turbine is stopped and gas is not delivered to the patient. Disconnect the patient from the ventilator and ventilate the patient using an alternative method. See *Chapter 15 - Troubleshooting, Alarms* for additional information concerning the **HIGH PRES** alarm.

**BAT EMPTY Alarm** - A BAT EMPTY alarm indicates the internal battery is almost depleted. Connect the ventilator to an external power source immediately.

## **WARNING**

**Battery run time** - When the battery reaches the BAT LOW level, the ventilator will only run for approximately 10 minutes before generating a battery empty alarm (BAT EMPTY). The approximate time shown is based on tests using the nominal settings, a new battery and a full 8 hour charge cycle as specified in *Appendix A - Ventilator Specifications*. Actual run time may be more or less depending on ventilator settings, patient demand, and battery age or condition. It is highly recommended that an alternate power source is connected PRIOR to the ventilator reaching the BAT EMPTY alarm condition to ensure continuous, uninterrupted patient ventilation

**INOP Alarm** - If an INOP alarm occurs during operation, ventilate the patient using an alternative method, disconnect the ventilator, and immediately contact a certified Pulmonetic Systems' service technician or Pulmonetic Systems, Inc.

**NO CAL Condition** - Operation of the LTV<sup>®</sup> 1200 ventilator under a NO CAL condition may result in inaccurate pressure and volume measurements. Should this condition occur, disconnect the patient from the ventilator, provide an alternative method of ventilation and immediately contact a certified Pulmonetic Systems' service technician or Pulmonetic Systems, Inc.

**XDCR FAULT Alarm** - Continued operation of the LTV<sup>®</sup> 1200 ventilator with an activated XDCR FAULT alarm may result in inaccurate flow and volume measurements. Should this condition occur, disconnect the patient from the ventilator, provide an alternative method of ventilation and immediately contact a certified Pulmonetic Systems' service technician or Pulmonetic Systems, Inc.

**Personal Injury and Electric Shock** - Operation of the LTV<sup>®</sup> 1200 ventilator if any of its panels have been removed may result in electrical shock to the patient or operator. All servicing must be performed by a certified Pulmonetic Systems' service technician.

**Audible Alarms** - Failure to immediately identify and correct audible alarm situations may result in serious patient injury.

**Equipment Malfunction or Failure** - The LTV<sup>®</sup> 1200 ventilator has alarms to notify operators of certain conditions and to cease operating upon detecting possible danger. In the event of equipment failure, all ventilator operators should have an alternative method of ventilation available and be fully familiar with emergency ventilation procedures.

**Improperly Functioning Ventilator** - Operation of a ventilator that does not appear to be working properly may be hazardous. If the ventilator is damaged, fails Ventilator Checkout tests or malfunctions in any way, discontinue its use and immediately contact a certified Pulmonetic Systems' service technician or Pulmonetic Systems, Inc.

**Ventilator Checkout Tests** - Be aware that gas is not delivered to the patient during these tests. Disconnect the patient from the ventilator and ventilate the patient using an alternative method before running the Ventilator Checkout tests.

**Ventilator Checkout and Maintenance Modes** - The LTV<sup>®</sup> 1200 ventilator does not deliver gas during the Ventilator Checkout mode (VENT CHECK) or Ventilator Maintenance mode (VENT MTNCE) and should not be used to ventilate a patient during these tests.

**Inspired Oxygen (FIO<sub>2</sub>) Concentration** - If the patient has a variable respiratory rate, his/her minute ventilation will fluctuate. If exact concentrations of inspired oxygen (FIO<sub>2</sub>) are required to be delivered to the patient, it is recommended that an accurate oxygen analyzer with alarms be used.

**O<sub>2</sub> Cylinder Duration Information** - The accuracy of the displayed useable amount of oxygen remaining in an external O<sub>2</sub> cylinder (O<sub>2</sub> DUR hh:mm) is dependant on the precision of the pressure gauge used on the O<sub>2</sub> cylinder and the accuracy of the information provided by the operator in the O<sub>2</sub> CYL DUR menu settings. The calculated/displayed useable amount of oxygen information is to be used for reference purposes only.

## **WARNING**

**Ventilation Variables and O<sub>2</sub> Consumption** - Variations in the patient's minute ventilation, I:E ratio and/or ventilator setting changes or equipment status (i.e. circuit leaks) affect the consumption rate of oxygen. When warranted by a patient's condition, it is recommended that a back-up cylinder or alternative source of oxygen be available at all times.

**Before Using Automobile Cigarette Lighter or Power Outlets** - Before using Automobile Cigarette Lighter or Power Outlets as a power source for the LTV® 1200, assure that the ventilator's internal battery is in good condition and fully charged. Poor cigarette lighter or power outlet connections, electrical system defects (battery, charging system, etc.), or use of vehicle accessories (air conditioner, high current lights, high power audio equipment, etc.) could result in less than the required voltage being delivered to the ventilator, generate a Power Lost alarm and switch the ventilator's power source to the internal battery.

**Unauthorized Parts or Accessories** - Serious harm to the patient may result from the use of unauthorized parts or accessories. Only items expressly approved by Pulmonetic Systems may be used in conjunction with the LTV® 1200 ventilators.

**Unapproved Adapters** - Only Pulmonetic Systems Accessories should be used to connect the ventilator to Patient Assist Call Systems. These accessories incorporate safety features to reduce the risk of shock. Do not attempt to modify these accessories in any way.

**Patient Assist Call Connector** - Do not apply more than 25V rms or 32VDC to the Patient Assist Call connector.

**Ventilator Service and Repair** - All servicing or repair of the LTV® 1200 ventilator must be performed only by a service technician certified by Pulmonetic Systems

**Patient Circuits** - Pulmonetic Systems Patient Circuits, Exhalation Valve Assemblies and Water Traps are shipped clean, not sterile.

**Ultra Violet Light Sensitivity** - The material used in the tubing of the Reusable Patient Circuits is not UV stable. Avoid exposure of the tubing to UV light.

**Mounting Screws** - Refer to the information contained in Pulmonetic Systems Replacement Screws Kit, P/N 11149, to determine the appropriate accessories mounting screws or accessories replacement screws location, type and length to use when removing or exchanging external accessories on an LTV® ventilator.

**Mounting Screw Use** - Internal damage to the ventilator may result if the wrong length mounting screws are used when installing or removing external accessories.

**Specific Boot Replacement Screw Location** - One leg of the upper protective boot has an additional screw hole (furthest from the end of the leg); On earlier version ventilators (screw was located in the upper hole in the leg of the boot) the use of a 3/16" mounting screw is required. On current version ventilators (screw was located in the lower hole in the leg of the boot) the use of a 1/4" mounting screw is required.

**Specific Boot Installation Screw Location** - One leg of the upper protective boot has an additional screw hole (furthest from the end of the leg); On earlier version ventilators, the screw hole will align with the upper hole in the boot and requires the use of the 1/4" mounting screw. On current version ventilators, the screw hole will align with the lower hole in the boot and requires the use of the 3/8" mounting screw.

**Patient Circuit Accessories** - The use of accessories such as Speaking Valves, Heat-Moisture Exchangers and Filters create additional patient circuit resistance and in the event of a disconnection, may impede the generation of a Low Pressure alarm. Ensure that the Low Pressure alarm settings accommodate these types of accessories when used in combination with patient circuits.



 **WARNING**

**Low Minute Volume Control Settings** - The **Low Min. Vol.** control should be set to its highest clinically appropriate value. If there is a clinical need to set the Low Minute Volume alarm to lower values or off (“- - -”), perform a clinical assessment to determine if an alternative monitor (i.e. a Pulse Oxymeter with an audible alarm, or a Cardio Respiratory Monitor) should be used.



## AVERTISSEMENT

**Personnel non qualifié** - Seul le personnel qualifié doit opérer le ventilateur. Le ventilateur de la 1200 LTV<sup>®</sup> est un dispositif médical restreint conçu pour être utilisé par les inhalothérapeutes ou autres personnes qualifiées, et par le personnel qualifié sous la supervision d'un médecin et en conformité avec les lois et règlements applicables.

**Contrôle de l'étanchéité du circuit respiratoire du patient** - L'étanchéité du circuit respiratoire du patient (vérification de ventilation) doit être vérifiée en mode **VENT CHECK** avant le raccordement au patient. En outre, on doit utiliser le mode Ventilator Checkout (vérification du ventilateur) afin de s'assurer du fonctionnement adéquat de l'alarme, des affichages et des commandes du ventilateur. Le défaut de vérifier l'étanchéité du circuit respiratoire du patient avant le raccordement à un patient peut être nocif pour le patient ou provoquer une ventilation inefficace. Lorsqu'un humidificateur chauffant est employé, il convient de l'inclure dans le circuit en procédant à la vérification de l'étanchéité.

**Alarmes réglables et critiques** - Pour assurer la sécurité et obtenir un fonctionnement adéquat, toutes les alarmes réglables et critiques doivent être vérifiées.

**Vérification du fonctionnement des alarmes** - Toutes les alarmes sonores et visuelles doivent être vérifiées quotidiennement. Si une des alarmes fonctionne de façon inadéquate, contactez votre technicien de service certifié de Pulmonetic Systems ou Pulmonetic Systems Inc.

**Surveillance du patient** - Un personnel qualifié doit constamment surveiller les patients qui sont reliés à un ventilateur. Le personnel doit être en mesure de s'occuper des déficiences de fonctionnement de l'équipement ainsi que des circonstances où ce dernier devient inopérant. Une forme de ventilation alternative doit être disponible à tous les patients reliés au ventilateur et le personnel qualifié devrait être pleinement familier avec les procédures de ventilation d'urgence.

**Ventilation alternative** - Il est recommandé qu'un moyen alternatif de ventilation soit disponible en tout temps, et que tous les opérateurs de ventilateur soient pleinement familiers avec les procédures de ventilation d'urgence.

**Feu ou explosion** - L'opération des ventilateurs de la 1200 LTV<sup>®</sup> en présence de gaz inflammables peut causer un feu ou une explosion. Le ventilateur ne doit être opéré sous aucune circonstance en présence de gaz. La présence d'oxyde nitreux ou d'anesthésiques inflammables représente un danger pour le patient et l'opérateur.

**Débranchement du circuit respiratoire du patient** - Le débranchement accidentel du circuit respiratoire du patient peut s'avérer dangereux.

**Alarmes critiques** - Le défaut de définir les alarmes critiques telles que l'alarme basse ventilation-minute et l'alarme basse pression peut causer une non-détection (absence d'alarme) pour un débranchement du tube de détection inférieur ou du tube d'entraînement de la soupape d'expiration.

**Diaphragme de la soupape d'expiration** - Une ventilation inefficace ou dangereuse pour le patient peut résulter si le diaphragme de la soupape est endommagé ou usé. Le diaphragme de la soupape d'expiration doit être vérifié quotidiennement, et remplacé au besoin.

**Alarme ALARME P<sub>MAX</sub> continue** - Dans des conditions d'alarme de haute pression prolongées (**ALARME P<sub>MAX</sub>**), la turbine du ventilateur s'arrête et le gaz n'est plus transmis au patient. Débranchez le patient du ventilateur et utilisez une autre méthode de ventilation. Pour plus de détails sur l'état **ALARME P<sub>MAX</sub>**, reportez-vous au *chapitre 15, Troubleshooting, Alarms*.



## AVERTISSEMENT

**Durée d'utilisation de la batterie** – Lorsque la batterie atteint le niveau BAT INT BASS, le ventilateur fonctionne pendant environ 10 minutes avant d'émettre une alarme de batterie faible (BAT INT VIDE). Cette durée approximative est basée sur des tests avec des paramètres nominaux, une nouvelle batterie et un cycle de chargement complet de 8 heures, tel que spécifié dans l'*Annexe A – Spécifications du ventilateur*. La durée d'utilisation réelle pourrait être supérieure ou inférieure, selon les paramètres du ventilateur, la demande du patient et l'âge ou l'état de la batterie. Il est fortement recommandé qu'une source d'alimentation alternative soit connectée AVANT que le ventilateur n'atteigne l'état d'alarme BAT INT VIDE afin d'assurer une ventilation continue et ininterrompue au patient.

**Alarme BAT EMPTY** - Une alarme BAT EMPTY indique que la pile interne est pratiquement à plat. Branchez immédiatement le ventilateur à une source d'alimentation externe.

**Alarme INOP** - Si une alarme INOP survient au cours de l'opération, ventilez le patient à l'aide de la méthode alternative, retirez immédiatement le ventilateur du service, et contactez immédiatement votre technicien de service certifié de Pulmonetic Systems ou Pulmonetic Systems Inc.

**Condition NO CAL** - L'opération continue du ventilateur de la série LTV® sous condition NO CAL peut résulter en mesures de pression et de volume erronées. Si cette condition se présente, le ventilateur doit être retiré du service, et vous devez immédiatement contacter votre technicien de service certifié de Pulmonetic Systems ou Pulmonetic Systems Inc.

**Alarme XDCR FAULT** - L'opération continue du ventilateur de la série LTV® avec une alarme XDCR FAULT activée peut résulter en mesures de débit et de volume erronées. Si cette condition se présente, le ventilateur doit être retiré du service, et vous devez immédiatement contacter votre technicien de service certifié de Pulmonetic Systems ou Pulmonetic Systems Inc.

**Blessures personnelles et chocs électriques** - L'opération d'un ventilateur de la série LTV® alors que ses panneaux sont enlevés, peut causer un choc électrique au patient ou à l'opérateur. Tout entretien doit être effectué par un technicien de service certifié de Pulmonetic Systems.

**Alarmes sonores** - L'échec à identifier et à corriger dans l'immédiat les situations d'alarmes sonores peut causer des blessures au patient.

**Mauvais fonctionnement ou panne de l'équipement** - Des dispositifs électromécaniques peuvent mal fonctionner ou subir une panne. Le ventilateur de la série LTV® a été conçu avec des alarmes, pour détecter et aviser les opérateurs de certaines conditions, et pour cesser d'opérer en cas de conditions d'opération dangereuses. En cas de panne de l'équipement, tous les opérateurs du ventilateur devraient avoir une forme de ventilation alternative à leur disponibilité, et être pleinement familiers avec les procédures de ventilation d'urgence.

**Ventilateurs fonctionnant de façon inadéquate** - L'opération d'un ventilateur dont le fonctionnement semble inadéquat peut représenter un danger. Si le ventilateur est endommagé, s'il échoue les tests de vérification du ventilateur ou s'il fonctionne de façon inadéquate, suspendez l'utilisation de ce ventilateur et contactez immédiatement votre technicien de service certifié de Pulmonetic Systems Inc.

**Tests de vérification du ventilateur** – Noter que le gaz n'est pas transmis au patient au cours de ces tests. Débrancher le patient du ventilateur et ventiler le patient à l'aide d'une forme de ventilation alternative avant de procéder aux tests de vérification du ventilateur.

**Modes Vérification et Entretien du ventilateur** - Le ventilateur de la série LTV® ne transmet pas le mélange de gaz en mode Vérification du ventilateur (VENT CHECK) ou en mode Entretien du ventilateur (VENT MTNCE), il ne devrait donc pas être utilisé pour ventiler un patient durant l'exécution de ces tests.

## **AVERTISSEMENT**

**Concentration d'oxygène inspiré (FIO<sub>2</sub>)** – Si la fréquence respiratoire du patient est variable, sa ventilation-minute va fluctuer. Lorsqu'une concentration exacte d'oxygène inspiré (FIO<sub>2</sub>) est nécessaire pour une transmission au patient, il est recommandé d'utiliser un analyseur de niveau d'oxygène<sup>2</sup> précis, comportant des alarmes.

**Informations sur la durée d'utilisation restante de la bouteille d'oxygène** - La précision de l'affichage de la quantité d'oxygène utilisable restante dans une bouteille d'oxygène externe (O2 DUR hh:mm) dépend de la précision de la jauge de pression utilisée sur la bouteille et de l'exactitude des informations fournies par l'opérateur dans les paramètres du menu DUREE CYL O2. Les informations calculées et affichées sur la quantité d'oxygène utilisable ne doivent être utilisées qu'à titre indicatif.

**Variables de ventilation et consommation d'oxygène** — Les variations dans la ventilation par minute du patient et dans le rapport inspiration/expiration, la modification des paramètres ou l'état du matériel (fuite dans le circuit, par exemple) modifient le taux de consommation de l'oxygène. Lorsque la situation du patient le permet, il est recommandé qu'une bouteille d'oxygène de secours ou toute autre source alternative d'oxygène soit disponible en permanence.

**Avant toute utilisation d'une prise d'allume-cigare ou d'une prise de courant** — Avant d'utiliser un allume-cigare ou une prise de courant comme source d'alimentation du ventilateur LTV®, vérifiez que la batterie interne du ventilateur est en bon état et entièrement chargée. L'utilisation d'un allume-cigare ou d'une prise de courant fournissant un branchement de qualité médiocre, des défauts du circuit électrique (batterie, système de charge, etc.), ou l'utilisation d'accessoires d'automobile (climatisation, phares, chaîne stéréo et haut-parleurs à forte consommation, etc.) peuvent affecter le voltage délivré au ventilateur et provoquer une sous-alimentation de celui-ci. Dans cette situation, le ventilateur déclenche une alarme PAS ALIM SEC et utilise la batterie interne du ventilateur comme source d'alimentation.

**Pièces, accessoires et options non autorisées** - Des dommages à l'équipement ou des blessures au patient peuvent survenir suite à l'utilisation de pièces, accessoires et options non autorisées. Seuls les éléments expressément approuvés par Pulmonetic Systems doivent être utilisés en conjonction avec les ventilateurs de la série LTV®.

**Accessoires non approuvés** – L'utilisation d'accessoires qui ne sont pas expressément approuvés par Pulmonetic Systems pourrait entraîner des conditions dangereuses. Seuls les accessoires de Pulmonetic Systems devraient être utilisés pour brancher les ventilateurs aux systèmes d'aide aux patients. Ces accessoires comportent des caractéristiques de sécurité pour réduire les risques de choc. N'essayez pas de modifier ces accessoires d'aucune façon.

**Connecteur d'appel d'aide aux patients** – Ne mettez pas plus de 25 V efficace ou 32 V c.c. au connecteur d'appel d'aide aux patients.

**Entretien et réparation du ventilateur** - Tout entretien ou réparation du ventilateur de la série LTV® ne doit être effectué que par un technicien de service certifié de Pulmonetic Systems.

**Circuits du patient** – Les circuits du patient du Pulmonetic Systems, les valves expiratoires et les collecteurs d'eau sont expédiés propres, mais pas stériles.

**Sensibilité à la lumière ultraviolette** – Les matériaux utilisés pour la tubulure des circuits du patient ne sont pas stables sous rayons UV. Éviter d'exposer la tubulure à la lumière UV.

**Vis de montage des accessoires** – Voir les renseignements fournis dans la trousse de vis de remplacement de Pulmonetic Systems, numéro de pièce 11149, pour déterminer l'emplacement, le type et la longueur des vis de montage d'accessoires ou des vis de remplacement pour accessoires à utiliser lors de la dépose ou de l'échange d'accessoires externes sur un ventilateur de la série LTV®.



## AVERTISSEMENT

**Utilisation des vis de montage** – Vous pourriez causer des dommages internes au ventilateur si des vis de montage de mauvaise longueur sont utilisées lors de l'installation ou de la dépose des accessoires externes.

**Emplacement des vis de remplacement d'un gaine spécifique** – Une patte de la gaine protectrice supérieure possède un trou de vis supplémentaire (le plus éloigné de l'extrémité de la patte);

- Sur les anciennes versions des ventilateurs (la vis se trouvait dans le trou supérieur de la patte de la gaine), vous devez utiliser une vis de montage de 3/16".
- Sur la version actuelle des ventilateurs (la vis se trouve dans le trou inférieur de la patte de la gaine), vous devez utiliser une vis de montage de 1/4".

**Emplacement des vis d'installation d'un gaine spécifique** – Une patte de la gaine protectrice supérieure possède un trou de vis supplémentaire (le plus éloigné de l'extrémité de la patte);

- Sur les anciennes versions des ventilateurs, le trou de la vis s'alignera au trou supérieur de la gaine et vous devez utiliser une vis de montage de 1/4".
- Sur la version actuelle des ventilateurs, le trou de la vis s'alignera au trou inférieur de la gaine et vous devez utiliser une vis de montage de 3/8".

**Accessoires du circuit du patient** - L'utilisation d'accessoires tels que les membranes vocales, les échangeurs thermohydriques et les filtres, produit une résistance additionnelle dans le circuit de patient et en cas de débranchement, elle risque d'empêcher la génération de l'alarme de basse pression. S'assurer que les paramètres de l'alarme de basse pression s'adaptent à ces types d'accessoires lorsqu'ils sont utilisés avec les circuits du patient.

**Réglages du contrôle de volume bas par minute** - Le contrôle du volume bas par minute doit être ajusté à la plus haute valeur clinique appropriée. Si l'alarme de volume bas par minute doit être ajustée à des valeurs inférieures ou mise à l'arrêt (" - - ") pour satisfaire aux besoins cliniques, effectuer une évaluation clinique afin de déterminer si l'utilisation d'un autre moniteur (c.-à-d., sphygmo-oxymètre muni d'une alarme sonore ou un moniteur cardio-respiratoire) s'avère pertinente.

## *Cautions*

---

### **CAUTION**

**Ventilator Sterilization** – To avoid irreparable damage to the LTV® 1200 ventilator, do not attempt to sterilize it.

**Cleaning Agents** – To avoid damaging the ventilator's plastic components and front panel, do not use cleaning agents containing ammonium chloride, other chloride compounds, more than 2% glutaraldehyde, phenols, or abrasive cleaners.

**Ventilator Immersion** - Do not immerse the ventilator in liquids.

**Reusable Patient Circuit Components** - To avoid degradation of the reusable patient circuit components, do not exceed the following constraints:

- 50 cleaning cycles or 1 year (whichever comes first)

**Steam Autoclave:**

- Pressure: 20 PSIG
- Temperature: 275°F (135°C)
- Time: 6 minutes

**Liquid Sterilizing Agent:**

- The use of liquid agents containing more than 2% glutaraldehyde.

**Pasteurization:**

- A 30-minute warm water detergent and a 30-minute 165°F (74°C) hot water cycle.
- Drying in a sterile drier for more than 1 hour or 140°F (59°C).

**Gas (ETO):**

- Temperature: 131°F (55°C)

**Differential Pressure Ports** - A low pressure air nozzle with flow less than 10 liters per minute should be used for cleaning the differential pressure ports.

**Exhalation Valve Cleaning** - Do not pour or spray liquid cleaners into the exhalation valve.

**Patient Wye Installation** – After cleaning, install the patient wye in the patient circuit so the proximal sense lines are oriented up while operating.

**Care of the Exhalation Valve** - The exhalation valve is a delicate assembly and may be damaged if;

- Care is not exercised when handling or cleaning it.
- Cleaning instruments or foreign bodies are inserted into it.
- High-pressure gas nozzles are used to dry it.

**Front Panel Cleaning** – Do not pour or spray liquid cleaners onto the front panel.

**Care of Bacterial Filters** – If bacterial filters are used in conjunction with the LTV® 1200 ventilator, comply with all procedures as specified by the filter manufacturer.

**Wet or Damp Filters** - Do not install a wet or damp filter into the LTV® 1200 ventilator. This could damage the ventilator.

## CAUTION

**Oxygen Supply Contamination** - The accuracy of the oxygen delivery capabilities of LTV<sup>®</sup> 1200 ventilator can be compromised by foreign debris contamination in the oxygen supply system. To reduce the risk of airborne contaminants entering the ventilator, ensure that any oxygen supply connected to the ventilator is clean, properly filtered<sup>1</sup> and that the ventilator's O<sub>2</sub> Inlet Port Cap is securely installed on the O<sub>2</sub> Inlet Port whenever the ventilator is not connected to an external oxygen supply.

**Proximal Sense Lines** - Do not remove the proximal sense lines from the patient wye.

**Automobile Cigarette Lighter and Power Outlets** – Automobile cigarette lighter and power outlets are normally wired for a positive center contact and ground sleeve contact. Connecting the ventilator to an improperly wired outlet will cause the adapter fuse to blow and may damage the adapter or the ventilator.

**Automobile Cigarette Lighter Outlet Power Rating** - Running a ventilator from an improperly rated automobile cigarette lighter outlet (less than 20 amperes) may cause a fuse in the automobile to blow, causing the ventilator and possibly other accessories in the automobile to stop operating.

**Automobile Cigarette Lighter Adapter** - Do not operate the ventilator from the Automobile Cigarette Lighter Adapter while starting the vehicle or when jump starting the automobile battery. Doing so may cause damage to the ventilator.

**Automobile Cigarette Lighter Adapter Tip** - Use care when disconnecting the Automobile Cigarette Lighter Adapter after use, its tip may be hot.

**Automobile Cigarette Lighter Outlet** – Depending on the condition of the automobile battery, whether the automobile is turned off, being started or running, automobile cigarette lighter outlets can provide varying levels of voltage (in some, the outlet only operates when the vehicle is running). Verify which power source the ventilator is using by checking the **External Power** LED on the ventilator.

**Remote Alarm** - Always verify that the remote alarm properly reports the LTV<sup>®</sup> 1200 ventilator alarms before use.

**Remote Alarm** - Always follow the remote alarm manufacturer's usage and maintenance requirements to guarantee proper function of the device.

**External Battery Pack** - The External Battery Pack should only be connected to the LTV<sup>®</sup> 1200 ventilator using the Pulmonetic Systems External Battery Cable (PN 10802). This cable is pre-wired and properly terminated to ensure safe connection of the External Battery Pack to the ventilator.

**Electrical Grounding** – In the event of a loss of electrical protective ground, touching the ventilator could result in electrical shock. To ensure grounding and avoid this danger, use only the unmodified power cord originally supplied with the LTV<sup>®</sup> 1200 ventilator, maintained in good condition and connected to a properly wired and grounded electrical power outlet.

**Do not cover the ventilator** – To avoid damage to the ventilator, do not cover while operating or position relative to other objects such that the operation or performance of the ventilator may be adversely affected. Ensure that sufficient space exists around the ventilator while in use to allow free circulation of gases.

---

<sup>1</sup> In addition to the existing internal O<sub>2</sub> Inlet filter, P/N 14313, an External, In-Line Oxygen Filter (P/N 14470) is available from Pulmonetic Systems, Inc.

## CAUTION

**Electrostatic Discharge** – The use of electrically conductive hoses and tubing is not recommended. The use of such materials may result in damage to the ventilator from electrostatic discharge.

**External DC Power Source or External Battery** - When connecting the LTV<sup>®</sup> 1200 ventilator to an external DC power source or external battery, use only the approved method and connectors specified in *Chapter 14 - Power and Battery Operation*.

**AC Power Source** - When connecting the ventilator to an AC power source, use only the approved LTV<sup>®</sup> AC Power Adapter.

**AC Power Earth Ground Validity** – If the validity of the AC power earth ground connection is in doubt, use the internal battery, an external battery, or an external DC power source to operate the LTV<sup>®</sup> 1200 ventilator.

**Fuse Fire Hazard** – Replacement of existing fuses with fuses with different voltage or electrical current ratings may cause a fire.

**Storage Temperature** - Storing the LTV<sup>®</sup> 1200 ventilator at temperatures above 60°C (140°F) for long periods can damage the internal battery and cause expected battery duration to degrade.

**Patient Assist Call Connector** – Do not apply more than 25V rms or 32VDC to the Patient Assist Call connector.

**Ventilator Checkout Tests** - LTV<sup>®</sup> 1200 ventilator Checkout tests must be performed before initial use of the ventilator. Rerun the tests whenever a question about the ventilator's operation arises.

**Release Button** - To avoid damaging the ventilator or the power connector, push the release button on the connector before removing it from the ventilator power port or the power port pigtail connector.



## ATTENTION

**Stérilisation du ventilateur** - Afin d'éviter des dommages irréparables au ventilateur de la 1200 LTV<sup>®</sup>, ne tentez pas de stériliser ce dernier.

**Produits de nettoyage** - Afin d'éviter d'endommager les composants plastiques et le panneau frontal du ventilateur, n'utilisez pas des produits de nettoyage contenant : chlorure d'ammonium, composés de chlorure, plus de 2% de glutaraldéhyde, ou phénol.

**Immersion du ventilateur** - Ne pas immerger le ventilateur dans des liquides, incluant les produits stérilisants.

**Composants réutilisables du circuit du patient** – Pour éviter la dégradation des composants réutilisables du circuit du patient, ne dépassez pas les limites suivantes:

- 50 cycles de nettoyage ou 1 an (le premier des deux prévalant)

**Autoclave à vapeur:**

- Pression : 20 lb/po<sup>2</sup>
- Température : 275°F (135°C)
- Durée : 6 minutes

**Agent de stérilisation liquide:**

- L'utilisation d'agents liquide contenant plus de 2% de glutaraldéhyde.

**Pasteurisation:**

- Un cycle avec détergent à l'eau tiède pendant 30 minutes et à l'eau chaude à 165°F (74°C) pendant 30 minutes.
- Séchage dans un séchoir stérile pendant plus de 1 heure ou à 140°F (59°C).

**Gaz (ETO):**

- Température : 131°F (55°C)

**Ports de pression différentielle** - Une source de gaz à débit faible (moins de 10 ppm) doit être utilisée pour le nettoyage des fluides et de débris des ports de pression différentielle.

**Nettoyage de la soupape d'expiration** - Ne pas asperger une solution nettoyante dans la soupape d'expiration.

**Installation de la soupape d'expiration** - Après le nettoyage, installez la soupape d'expiration dans le circuit du patient de sorte que les lignes de détection soient alignées vers le haut pendant l'opération.

**Entretien de la soupape d'expiration** - La soupape d'expiration est une pièce fragile et peut être endommagée si :

- Des précautions ne sont pas prises lors de sa manipulation ou de son nettoyage.
- Des instruments de nettoyage ou des corps étrangers sont insérés dans celle-ci.
- Des pistolets de gaz à haute-pression sont utilisés pour l'assécher.

**Nettoyage du panneau frontal** - Ne pas asperger des solutions nettoyantes ou les laisser s'écouler sur le panneau frontal.

**Entretien des filtres bactériens** - Les filtres bactériens ne devraient pas être immergés dans un liquide. Un autoclave à vapeur devrait être utilisé pour le nettoyage des filtres bactériens.

## ATTENTION

**Filtres mouillés ou humides** - Ne pas installer des filtres mouillés ou humides dans les ventilateurs de la série LTV<sup>®</sup>. Cela pourrait endommager le ventilateur.

**Contamination de la réserve d'oxygène** — La précision de la capacité d'alimentation en oxygène des ventilateurs LTV<sup>®</sup> peut être compromise par la présence de corps étrangers dans le système d'alimentation en oxygène. Afin de diminuer le risque de présence d'agents contaminants atmosphériques dans le ventilateur, assurez-vous que la réserve d'oxygène reliée au ventilateur est propre et filtrée de manière adéquate<sup>2</sup>, et que le bouchon de l'orifice d'alimentation en oxygène est correctement installé à chaque fois que le ventilateur n'est pas relié à une source d'oxygène externe.

**Conduites de détection** – N'enlevez pas les conduites de détection qui se trouvent sur les divisions en Y du circuit du patient.

**Allume-cigare et prises de courant** – L'allume-cigare et les prises de courant sont habituellement câblés de façon à obtenir un contact central positif et un contact du manchon à la terre. Le branchement du ventilateur dans une prise qui n'est pas câblée adéquatement aura pour effet de faire sauter le fusible de l'adaptateur et pourrait endommager l'adaptateur ou le ventilateur.

**Puissance nominale des prises d'allume-cigare** – Le branchement d'un ventilateur à une prise d'allume-cigare qui ne possède pas la tension suffisante (moins de 20 ampères) peut faire griller un fusible de l'automobile, causant ainsi l'arrêt du ventilateur et éventuellement, celui d'autres accessoires de l'automobile.

**Adaptateur pour allume-cigare** – Ne faites pas fonctionner le ventilateur à l'aide de l'adaptateur pour allume-cigare lorsque vous démarrez le véhicule ou lorsque vous faites une connexion provisoire de la batterie d'un véhicule. Vous pourriez ainsi endommager le ventilateur.

**Embout adaptateur pour allume-cigarette d'automobile** - Après l'utilisation, débrancher l'adaptateur pour allume-cigarette d'automobile avec précaution car son embout peut être chaud.

**Prise d'allume-cigare d'automobile** – Selon la condition de la batterie de l'automobile, si le moteur est coupé, démarré ou est en marche, les prises d'allume-cigare d'une automobile peut générer des niveaux de tension variés (sur certains modèles, la prise ne fonctionne que si le moteur est en marche). Vérifier la source d'alimentation utilisée par le ventilateur indiquée par la DEL **External Power** du ventilateur.

**Alarme à distance** – Assurez-vous toujours que l'alarme à distance indique de façon adéquate les alarmes du ventilateur LTV<sup>®</sup> avant d'utiliser le ventilateur.

**Alarme à distance** – Suivez toujours les exigences d'utilisation et d'entretien du fabricant de l'alarme à distance afin d'assurer le fonctionnement adéquat de l'appareil.

**Bloc-piles externe** – Le bloc-piles externe ne doit être branché qu'aux ventilateurs de la 1200 LTV<sup>®</sup> à l'aide du câble pour piles externes de Pulmonetic Systems (N<sup>o</sup> pièce 10802). Ce câble est précâblé et ses terminaisons assurent une connexion sécuritaire entre le bloc-piles externe et le ventilateur.

**Mise électrique à la terre** - En cas de perte de la mise électrique à la terre de protection, toutes les pièces conductrices peuvent transmettre un choc électrique. Pour éviter un choc électrique, n'utilisez que le cordon d'alimentation d'origine non modifié fourni avec les ventilateurs de la 1200 LTV<sup>®</sup>, maintenus en bonne condition, et branchés à une prise adéquatement câblée et mise à la terre.

**Ne recouvrez pas le ventilateur** – En vue d'éviter le risque de dommages du ventilateur, ne le recouvrez pas pendant son fonctionnement ou ne le positionnez pas en relation avec d'autres objets de sorte que le fonctionnement ou le rendement du ventilateur puisse en être négativement affecté. Assurez-vous qu'un espace suffisant existe autour du ventilateur pendant son utilisation afin de permettre une bonne circulation des gaz.

<sup>2</sup> En plus du filtre interne de l'orifice d'alimentation en oxygène, dont le numéro de pièce est 14313, Pulmonetic Systems, Inc. propose un filtre à oxygène externe, de numéro de pièce 14470.

## ATTENTION

**Choc électrostatique** – L'utilisation de tuyaux et de tubes conductibles n'est pas recommandée. L'utilisation de ces matériaux risque de causer une décharge électrostatique qui endommagerait le ventilateur.

**Source de courant continu ou pile externe** - Lorsque vous branchez les ventilateurs de la 1200 LTV® sur une source de courant continu ou sur une pile externe, utilisez seulement les méthodes et les connecteurs approuvés spécifiés au chapitre 14 - Alimentation et opération avec pile.

**Source d'alimentation c.a.** - Lorsque vous branchez le ventilateur sur une source d'alimentation c.a., utilisez l'adaptateur c.a. LTV® approuvé.

**Validité de la mise à la terre de l'alimentation c.a.** - Si vous doutez de la validité de la mise à la terre de l'alimentation c.a., utilisez la pile interne, une pile externe ou une source externe de courant continu, pour opérer le ventilateur de la 1200 LTV®.

**Danger d'incendie des fusibles** - Le remplacement des fusibles existants par des fusibles de type, d'ampérage et de courant électrique différent peut causer un incendie.

**Température d'entreposage** - L'entreposage du ventilateur de la 1200 LTV® à des températures supérieures à 60° C (140° F) durant des périodes prolongées peut endommager la pile interne et causer l'usure prématurée de la pile.







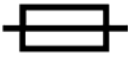

**Connecteur d'appel d'aide aux patients** - Ne mettez pas plus de 25 V efficace ou 32 V c.c. au connecteur d'appel d'aide aux patients.

**Tests de vérification du ventilateur** - Les tests de vérification du ventilateur doivent être effectués avant de relier le patient au ventilateur. Effectuez les tests lors de doutes relativement à l'opération adéquate du ventilateur.

**Bouton de déclenchement** – Pour éviter d'endommager le ventilateur ou le connecteur d'alimentation, appuyer sur le bouton de déclenchement situé sur le connecteur avant de le retirer du port d'alimentation du ventilateur ou du raccord de queue de cochon du port d'alimentation.

**Ne recouvrez pas le ventilateur** – Afin d'éviter tout risque de dommages au ventilateur, ne le recouvrez pas pendant son fonctionnement et positionnez-le de manière à ce que son fonctionnement ou son rendement ne puisse être gêné par d'autres objets. Assurez-vous qu'un espace suffisant existe autour du ventilateur pendant son utilisation afin de permettre une bonne circulation des gaz.

## Symbols

Symbol	Compliance <sup>3</sup>	Title	Application
	ISO 3864 (Prev. IEC 348) Symbol No.B.3.1	Caution (refer to accompanying documents)	Used to direct the user to the instruction manual where it is necessary to follow certain specified instructions where safety is involved.
	IEC 417 Symbol No. 417-IEC-5016	Fuse	To indicate the fuse boxes, for example, and their location.
	IEC 417 Symbol No. 417-IEC-5035	Output	To identify an output terminal when it is necessary to distinguish between inputs and outputs.
	IEC 417 Symbol No. 417-IEC-5019	Protective earth (ground)	To identify any terminal which is intended for connection to an external protective conductor for protection against electric shock in case of a fault or the terminal of a protective earth (ground) electrode.
	IEC 417 Symbol No. 417-IEC-5333	Type BF equipment.	To mark a type BF equipment complying with IEC Publication 601.
	IEC 417 Symbol No. 417-IEC-5031	Direct Current	To indicate on the rating plate that the equipment is suitable for direct current only; to identify relevant terminals.
	IEC 417 Symbol No. 417-IEC-5032	Alternating current	To indicate on the rating plate that the equipment is suitable for alternating current only; to identify relevant terminals.
	IEC 417 Symbol No. 417-IEC-5172	Class II equipment	To identify equipment meeting safety requirements specified for Class II equipment.
	IEC 60417 Symbol No. 5182	Sound; audio	Used to identify controls or terminals related to audio signals.

<sup>3</sup> Reference IEC Medical Electrical Equipment, 2<sup>nd</sup>. Edition 1988



## *Chapter 2 - VENTILATOR OVERVIEW*

The LTV<sup>®</sup> 1200 ventilator is a lightweight, high performance ventilator that is designed to provide the maximum functionality in the smallest possible package. The LTV<sup>®</sup> 1200 ventilator provides the following features:

- High performance ventilation in a small lightweight package (10" x 12" x 3", 13.4 lbs).
- Turbine technology allows the ventilator to operate without an external compressed gas source.
- CPAP<sup>4</sup>, SIMV<sup>5</sup>, Control, Assist/Control and Apnea Backup ventilation modes.
- NPPV<sup>6</sup> mode ventilation, providing an alarm package suitable for mask ventilation.
- Volume Control, Pressure Control and Pressure Support ventilation.
- Spontaneous Breathing Trial (SBT) to assist with weaning and discontinuation of ventilatory support.
- Variable alarm settings including High Peak Pressure, Low Peak Pressure, Low Minute Volume, Apnea, High Breath Rate, High PEEP and Low PEEP.
- Oxygen Blending from a High-Pressure Oxygen source, Low-Pressure Oxygen Bleed-in, O<sub>2</sub> Flush, and O<sub>2</sub> Cylinder Duration Monitoring
- Lockable front panel controls.
- Monitors for Breath Rate (f), I:E Ratio, MAP, Minute Ventilation (VE), PEEP, PIP and Tidal Volume (V<sub>t</sub>e).
- Real-time patient circuit pressure display with Peak Inspiratory Pressure indicator.
- Variable termination conditions for Pressure Support breaths, including maximum inspiratory time termination and percentage of peak flow.
- Selectable Percentage of Peak Flow termination for Pressure Control breaths.
- Presets to facilitate rapid patient set-up.
- Leak Compensation to improve triggering when a circuit leak is present.
- Single or dual tone output capabilities.
- Operation from a variety of power sources including AC power, internal battery and external DC power sources.

### *Indications for Use*

---

The LTV 1200 ventilator is intended to provide continuous or intermittent ventilatory support for the care of the individuals who require mechanical ventilation. The ventilator is a restricted medical device intended for use by qualified, trained personnel under the direction of a physician. Specifically, the ventilator is applicable for adult and pediatric patients weighing at least 5kg (11 lbs.), who require the following types of ventilatory support:

- Positive Pressure Ventilation, delivered invasively (via ET tube) or non-invasively (via mask).
- Assist/Control, SIMV, CPAP, or NPPV modes of ventilation.

The ventilator is suitable for use in institutional, home, or transport settings.

**CAUTION: Federal law restricts this device to sale by or on the order of a physician.**

---

<sup>4</sup> Continuous Positive Pressure Ventilation

<sup>5</sup> Synchronized Intermittent Mandatory Ventilation

<sup>6</sup> Non-invasive Positive Pressure Ventilation

## Power/Supplies Required

---

To operate the LTV<sup>®</sup> 1200 ventilator, you will need the following:

- Power source: Pulmonetic Systems P/N 10537, 110V or 220V AC power source, or 11V to 15V DC power source. This may be an external battery or a DC power system<sup>7</sup>.
- For enriched FIO<sub>2</sub>: High-pressure oxygen source providing between 40 PSIG and 80 PSIG, or Low-flow, low-pressure oxygen source providing less than 10 PSIG.

### **WARNING**

**Untrained Personnel** – Only properly trained personnel should operate the ventilator. The LTV<sup>®</sup> 1200 ventilator is a restricted medical device designed for use by Respiratory Therapists or other properly trained and qualified personnel under the direction of a physician and in accordance with applicable state laws and regulations.

**Patient Monitoring** - Patients who are dependent on a ventilator should be constantly monitored by qualified personnel. Such personnel should be prepared to address equipment malfunctions and circumstances where equipment becomes inoperative. An alternative method of ventilation should be available for all patients dependent on the ventilator, and qualified personnel should be fully familiar with emergency ventilation procedures.

### **AVERTISSEMENT**

**Personnel non qualifié** - Seul le personnel qualifié doit opérer le ventilateur. Le ventilateur de la 1200 LTV<sup>®</sup> est un dispositif médical restreint conçu pour être utilisé par les inhalothérapeutes ou autres personnes qualifiées, et par le personnel qualifié sous la supervision d'un médecin et en conformité avec les lois et règlements applicables.

**Surveillance du patient** – Un personnel qualifié doit constamment surveiller les patients qui sont reliés à un ventilateur. Le personnel doit être en mesure de s'occuper des déficiences de fonctionnement de l'équipement ainsi que des circonstances où ce dernier devient inopérant. Une forme de ventilation alternative doit être disponible à tous les patients reliés au ventilateur et le personnel qualifié devrait être pleinement familier avec les procédures de ventilation d'urgence.

---

<sup>7</sup> Airline carriers typically allow only dry cell batteries on board aircraft. However, some airlines may allow an electrical cord to be plugged in if arranged in advance. Pulmonetic Systems recommends checking with the intended carrier well in advance before traveling.

## *Information/Assistance*

---

For additional information or troubleshooting assistance concerning the operation of the LTV<sup>®</sup> 1200 ventilator, contact a certified Pulmonetic Systems' service technician or:

---

### **Pulmonetic Systems, Inc.**

17400 Medina Rd., Suite 100  
Minneapolis, Minnesota 55447-1341  
Phone: (763) 398-8300  
Customer Care Center: (800) 754-1914  
Fax: (763) 398-8400  
E-mail: [info@pulmonetic.com](mailto:info@pulmonetic.com)  
Website: <http://www.pulmonetic.com>





## Chapter 3 - BREATH TYPES

This chapter contains information regarding the breath types available on the LTV<sup>®</sup> 1200 ventilator. It covers how breaths are initiated, limited and cycled, and when each type of breath is given.

The following terms are used in discussing how breaths are given:

- Initiate**      What causes a breath to be given. Breaths may be initiated by a patient trigger, a push of the **Manual Breath** button, or by the ventilator based on the set breath rate and ventilation mode.
- Limit**         How the breath is controlled. Breaths may be limited to a maximum circuit pressure or flow.
- Cycle**         What causes the breath to be cycled from the inspiratory phase to the exhalation phase. Breaths may be cycled by the ventilator when a set time or delivered volume has been reached, or when an alarm condition such as a high pressure limit has been reached.

### *Breath Types*

---

Breaths are defined by how they are initiated, limited and cycled. The breath types are Machine, Assist, and Patient.

	<u>Machine</u>	<u>Assist</u>	<u>Patient</u> <sup>8</sup>
<b>Initiated By</b> -	Ventilator	Patient	Patient
<b>Limited By</b> -	Ventilator	Ventilator	Ventilator
<b>Cycled By</b> -	Ventilator	Ventilator	Patient

Breaths may be given in any of the following forms: Volume Control, Pressure Control, Pressure Support and Spontaneous. These breaths are given as described in the sections below.

In addition, the following parameters apply to all breaths:

- The Minimum Inspiratory Time is 300 ms.
- The Minimum Exhalation Time is 346 ms.
- When patient triggers are enabled, triggers are detected during exhalation after the Minimum Exhalation Time has expired.

---

<sup>8</sup> Pressure Support or Spontaneous

## Volume Control Breaths

For Volume Control breaths, the set Tidal Volume is delivered over the set Inspiratory Time and flow is delivered in a decelerating taper flow waveform. Peak flow is calculated based on the Tidal Volume and Inspiratory Time and the final flow is 50% of the peak flow. Volume breaths may be machine or assist type breaths.

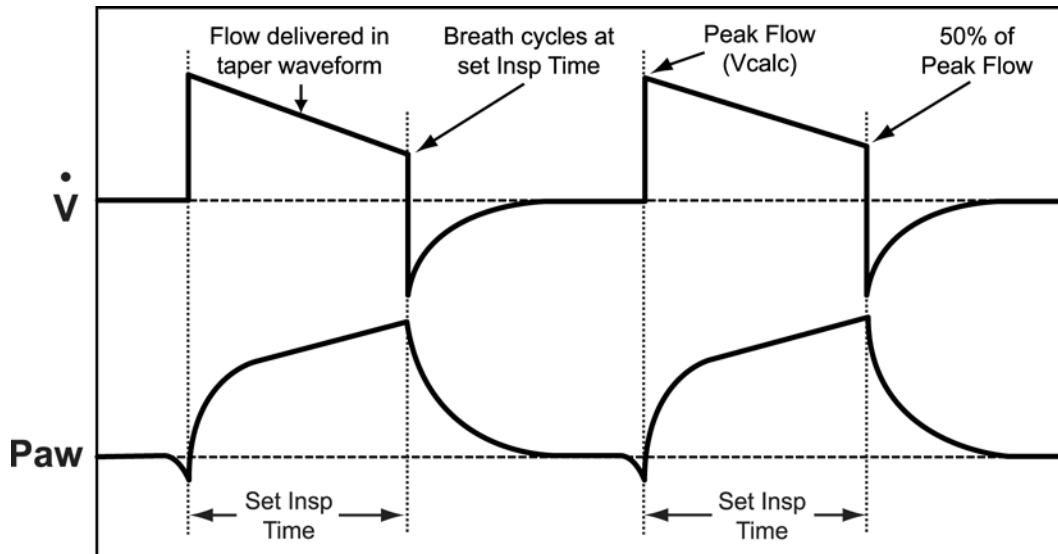

**Volume Control Breaths**

When the combination of inspiratory time and tidal volume result in an initial flow of <20 Lpm, the final flow remains at 10 lpm and the waveform is flattened.

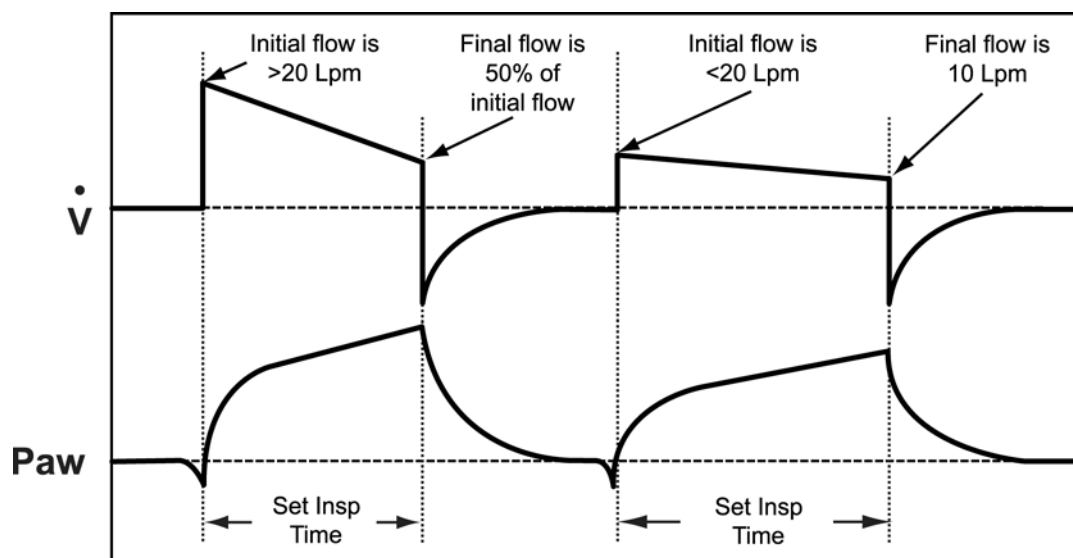

**Volume Control Breaths**

## Pressure Control Breaths

For Pressure Control breaths<sup>9</sup>, flow is delivered to elevate the circuit pressure to the Pressure Control setting and maintain it at that pressure for the set Inspiratory Time. Pressure Control breaths may be machine or assist type breaths.

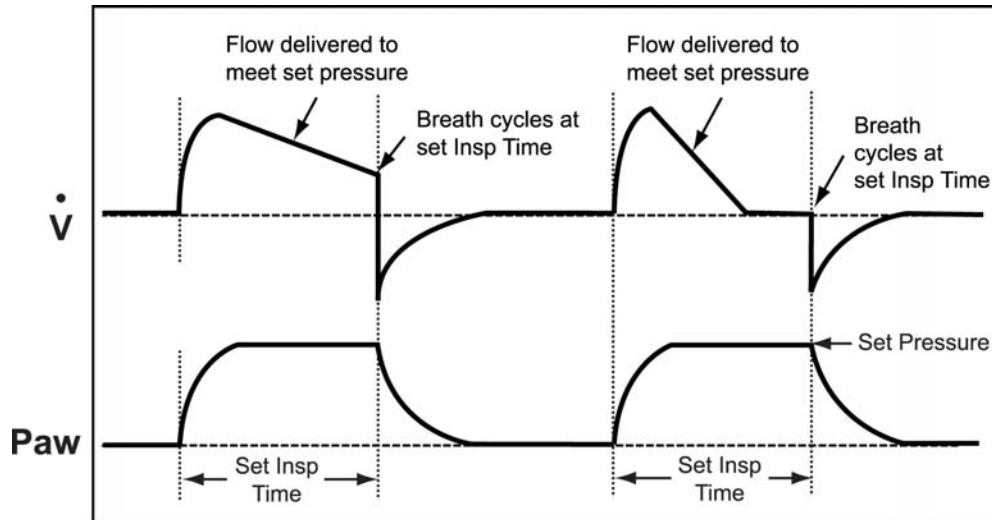

### Pressure Control Breaths

Shown with example flow patterns for two different patient conditions

Adjusting the Rise Time Profile changes the flow and pressure waveforms for Pressure Control breaths.

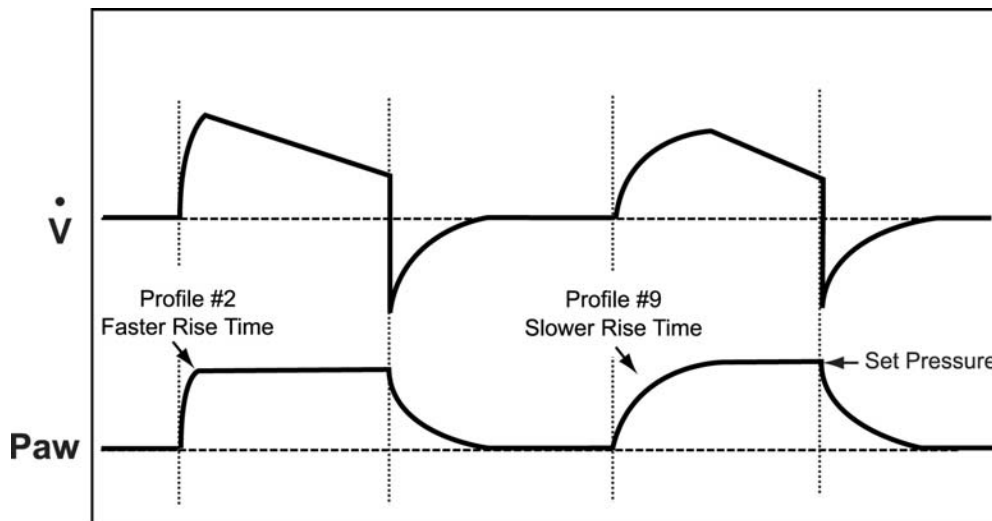

### Adjusting Rise Time on Pressure Control Breaths

<sup>9</sup> Pressure Control and Pressure Support breaths do compensate for PEEP. For example, a Pressure Control setting of 20cmH<sub>2</sub>O and a PEEP setting of 10cmH<sub>2</sub>O results in a Peak Inspiratory Pressure (PIP) of 30cmH<sub>2</sub>O (20 cmH<sub>2</sub>O over the set PEEP).

### Pressure Control Breaths (cont)

Pressure Control breaths have an optional flow termination criteria. If PC Flow Termination is ON Pressure Control breaths may be time or flow terminated. If the flow drops to the set FLOW TERM level before the inspiratory time is completed, the inspiration is cycled.

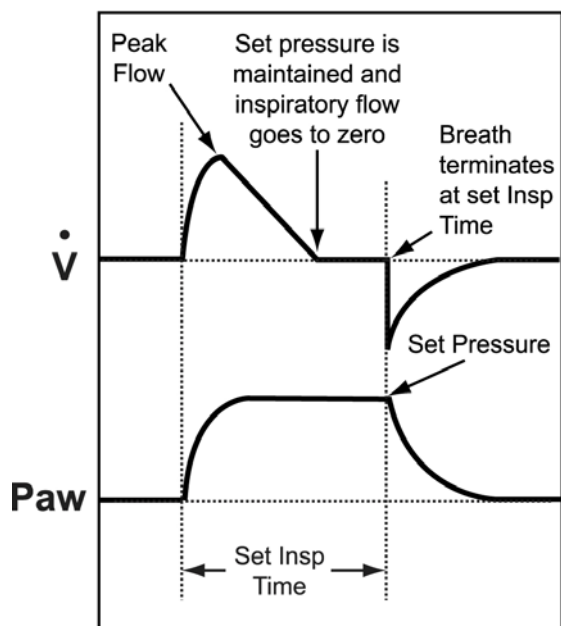

**PC FLOW TERM set to OFF**

Pressure Control Breath terminates normally

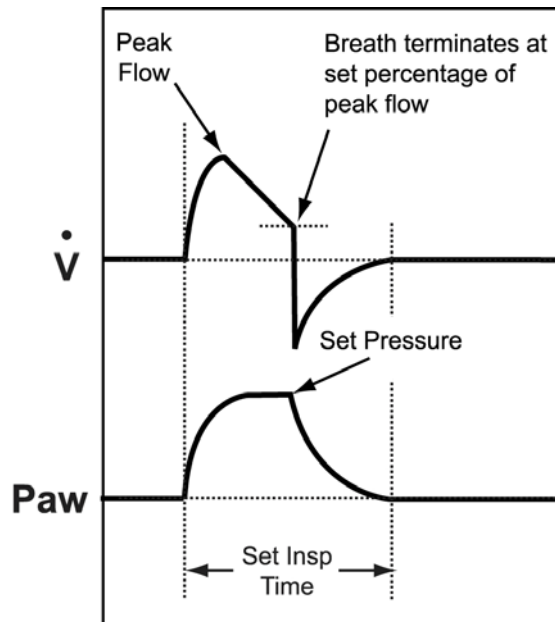

**PC FLOW TERM set to ON**

Pressure Control Breath terminates at the same Percentage of Peak Flow as Pressure Support breaths

## Pressure Support Breaths

For Pressure Support breaths<sup>10</sup>, flow is delivered to elevate the circuit pressure to the Pressure Support setting and maintain it at that pressure until the flow drops below a variable percentage of the peak flow. Pressure Support breaths may also be cycled by a variable time limit, or by exceeding 2 breath periods. Pressure support breaths are patient type breaths.

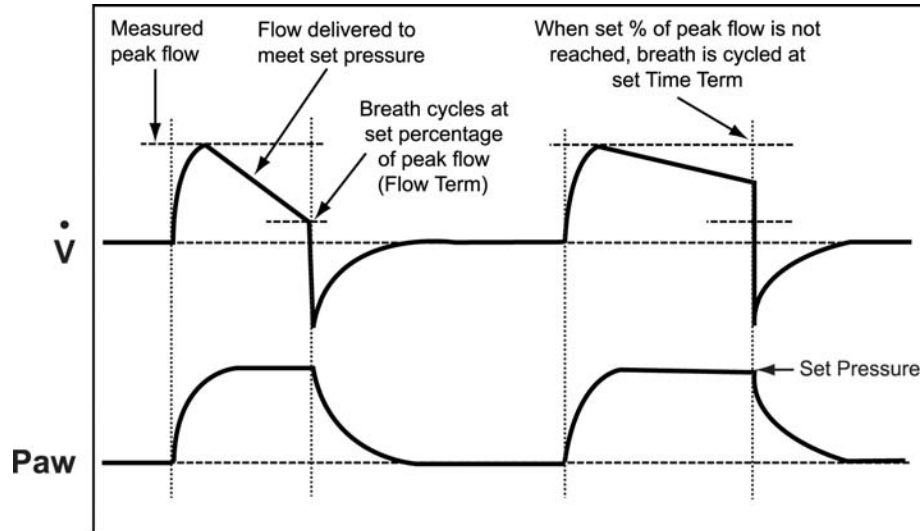

**Pressure Support Breaths**

For some patients, it may be useful to adjust the variable flow termination percentage. Adjusting the FLOW TERM setting between 10% and 40% will change the length, volume and comfort of the inspiration.

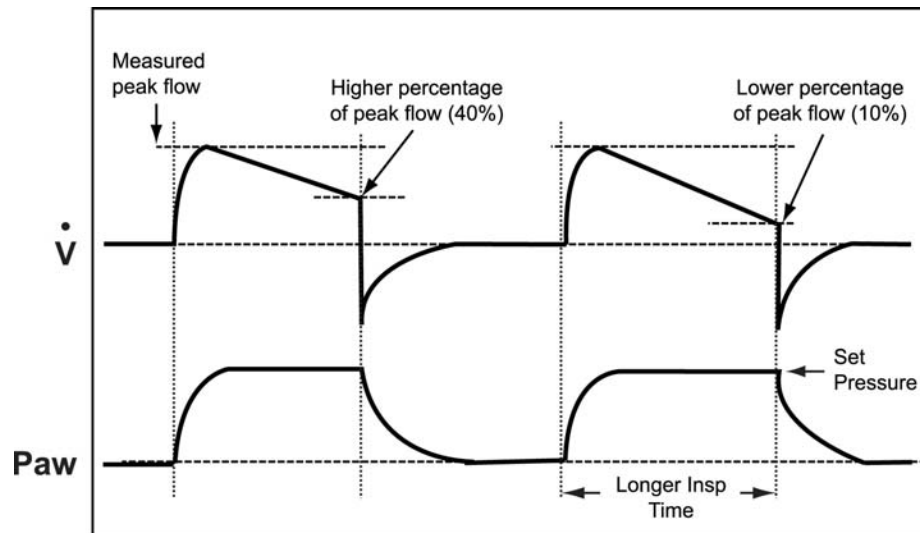

**Adjusting Flow Term on Pressure Support Breaths**

<sup>10</sup> Pressure Control and Pressure Support breaths do compensate for PEEP. For example, a Pressure Control setting of 20cmH<sub>2</sub>O and a PEEP setting of 10cmH<sub>2</sub>O results in a Peak Inspiratory Pressure (PIP) of 30cmH<sub>2</sub>O (20 cmH<sub>2</sub>O over the set PEEP).

## Spontaneous Breaths

For Spontaneous breaths, flow is delivered to meet patient demand and maintain the circuit pressure at the measured PEEP from the previous breath. The breath is cycled when the flow drops below the Pressure Support Flow Termination setting, or below 3 lpm. Spontaneous breaths may also be terminated by exceeding 2 breath periods. Spontaneous breaths are patient type breaths.

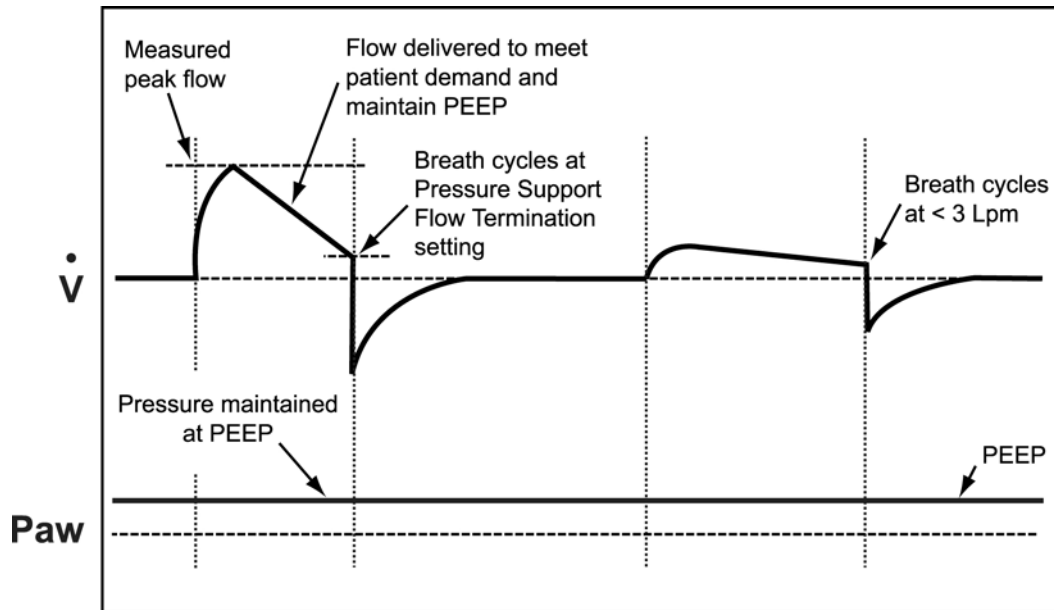

### Spontaneous Breaths

Shown with example flow for two different patient conditions

## Chapter 4 - VENTILATION MODES

The LTV<sup>®</sup> 1200 ventilator provides the following modes of ventilation:

- Control
- Assist/Control
- SIMV - Synchronized Intermittent Mandatory Ventilation
- CPAP - Continuous Positive Airway Pressure
- Apnea Backup Ventilation
- NPPV - Non-Invasive Positive Pressure Ventilation

Each of these modes is described below.

### Control Mode

Control mode ventilation is selected when **Assist/ Ctrl** is selected and **Sensitivity** is set to a dash “-”. In Control mode, Volume or Pressure Controlled machine breaths are given at the rate specified by the **Breath Rate** setting and no triggered breaths are allowed.

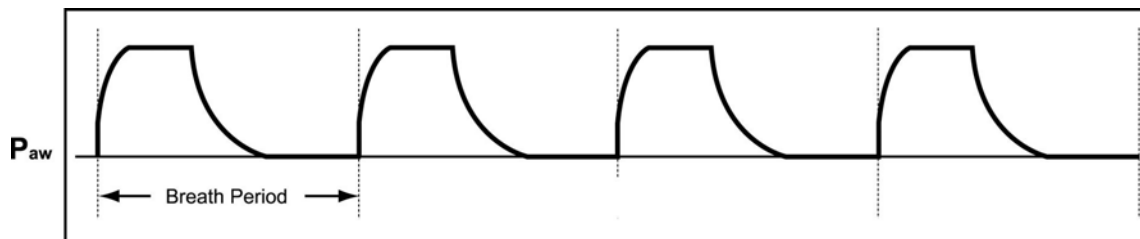

Pressure Control Machine Breaths

### Assist/Control Mode

Assist/Control ventilation is selected when **Assist/ Ctrl** is selected and **Sensitivity** is on. In Assist/Control mode, the ventilator guarantees a minimum number of Volume or Pressure Controlled breaths are given. The patient may trigger additional Volume or Pressure Controlled assist breaths.

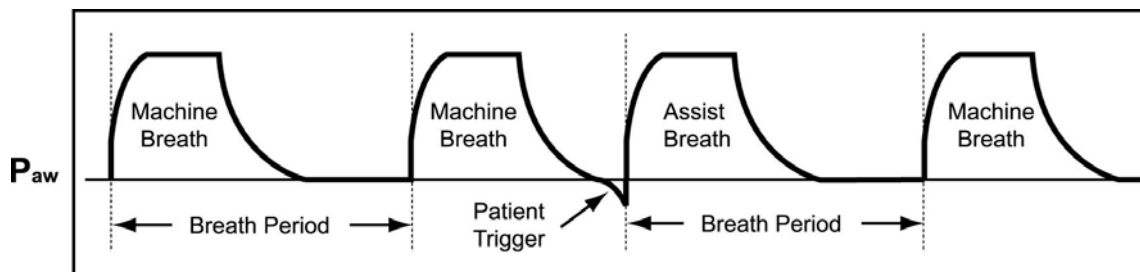

Pressure Control Machine and Assist Breaths



## SIMV Mode

SIMV mode is selected when **SIMV/CPAP** is selected and the **Breath Rate** is set between 1 and 80. In SIMV mode, machine, assist and patient breaths may be given.

For the first patient trigger detected within a breath period, an assist breath is given. For all subsequent patient triggers within the same breath period, spontaneous patient breaths or pressure support if set, are given.

At the beginning of a breath period, if no triggered breaths were given in the previous breath period, a machine breath is given. If there was a patient trigger in the previous breath cycle, the ventilator will not give a machine breath in the current breath period unless the set Apnea Interval is exceeded.

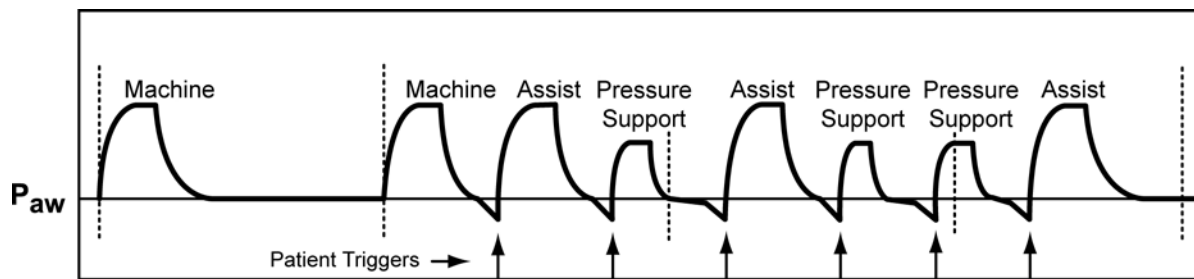

**Pressure Control Machine and Assist Breaths, and Pressure Support Breaths**

### NOTE

LTV<sup>®</sup> ventilators provide an Apnea Backup mode of ventilation. When the set Apnea Interval (maximum time allowed between the beginning of one breath and the beginning of the next breath) is exceeded, the **APNEA** alarm is generated and the ventilator will enter Apnea Backup ventilation mode.

### REMARQUE

Les ventilateurs LTV<sup>®</sup> procurent un mode de ventilation de secours pour l'apnée. Lorsque l'intervalle de l'apnée établi (durée maximum allouée entre le début d'une respiration et le début de la respiration suivante) est excédé, l'alarme **APNEA** est générée et le ventilateur entre en mode de ventilation de secours pour l'apnée.

## CPAP Mode

CPAP mode is selected when **SIMV/CPAP** is selected and the **Breath Rate** is set to dashes "--". In CPAP mode, when a patient trigger is detected, a patient breath is given. Breaths will be Pressure Support or Spontaneous breaths according to the Pressure Support setting.

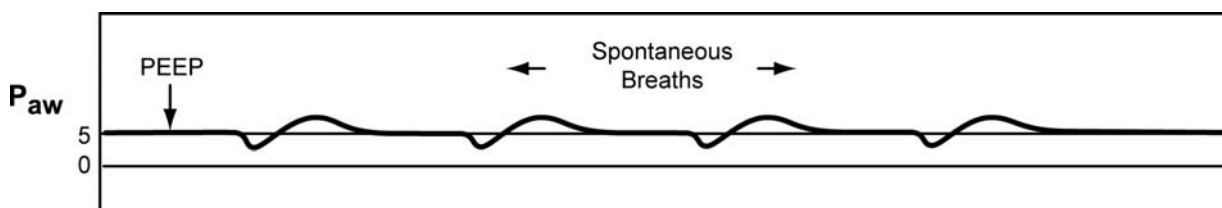
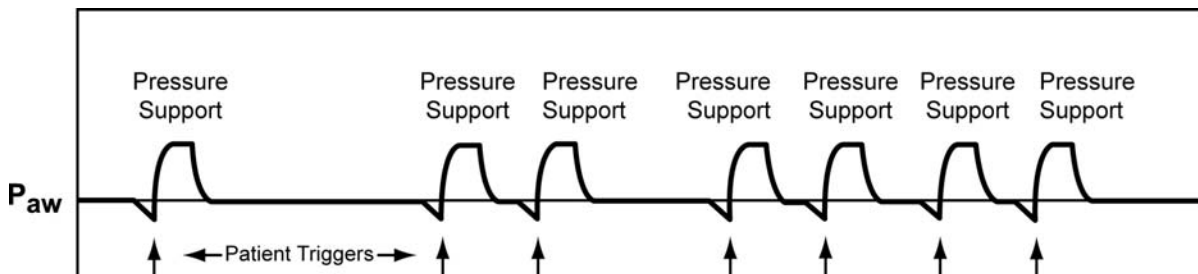

### NOTE

LTV<sup>®</sup> ventilators provide an Apnea Backup mode of ventilation. When the set Apnea Interval (maximum time allowed between the beginning of one breath and the beginning of the next breath) is exceeded, the **APNEA** alarm is generated and the ventilator will enter Apnea Backup ventilation mode.

### REMARQUE

Ventilateur LTV<sup>®</sup> procurent un mode de ventilation de secours pour l'apnée. Lorsque l'intervalle de l'apnée établi (durée maximum allouée entre le début d'une respiration et le début de la respiration suivante) est excédé, l'alarme **APNEA** est générée et le ventilateur entre en mode de ventilation de secours pour l'apnée.

## NPPV Mode

---

Non-invasive Positive Pressure Ventilation, (NPPV) can be selected as the primary mode of ventilation. In the **NPPV** mode, the ventilator cycles between IPAP (Pressure Support) and EPAP (PEEP). When a patient trigger is detected, a Pressure Support patient breath is given.

### NOTE

Masks used with the LTV 1200 *must be non-vented*. With a vented mask, the patient's exhaled air escapes via holes in the mask, elbow or swivel connector. With a non-vented mask, the patient's exhaled air escapes through the ventilator exhalation valve.

### REMARQUE

Les masques utilisés avec l'appareil LTV 1200 *doivent être non ventilés*. Avec un masque ventilé, l'air expiré par le patient s'évacue par les ouvertures du masque, le coude ou le raccord pivotant. Avec un masque non ventilé, l'air expiré par le patient s'évacue par la valve expiratoire du ventilateur.

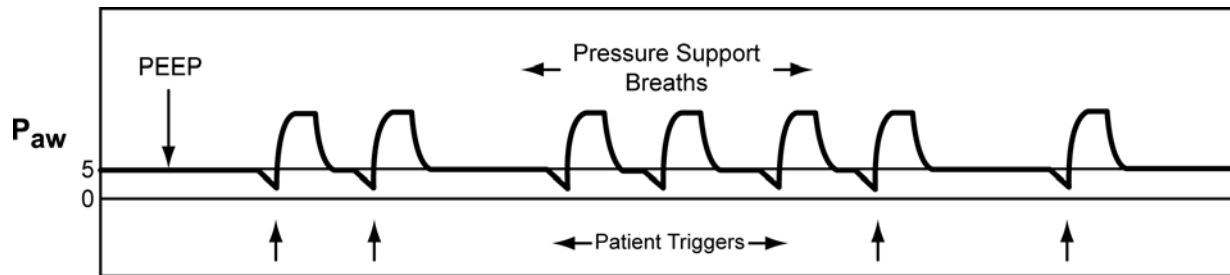

IPAP / EPAP Patient Breaths

## Apnea Backup

The LTV<sup>®</sup> 1200 ventilator provides an Apnea Backup mode of ventilation. Apnea Backup ventilation begins when the time since the last breath start is greater than the set Apnea Interval.

### When an apnea alarm occurs:

- If an inspiration is in progress, the ventilator cycles to exhalation.
- The ventilator begins Apnea Backup ventilation in the Assist/Control mode according to the current control settings. The active controls are displayed at full intensity, and all other controls are dimmed.

The breath rate for Apnea Backup mode is determined as follows:

- If the set Breath Rate is  $\geq 12$  bpm, the Apnea breath rate is the set Breath Rate.
- If the set Breath Rate is  $< 12$  bpm and the set Breath Rate is not limited by other control settings, the Apnea breath rate is 12 bpm.
- If the set Breath Rate is limited to  $< 12$  bpm, the Apnea breath rate is the highest allowed rate.

The ventilator exits the Apnea Backup mode and returns to the previous mode of ventilation when the operator resets the Apnea alarm or when two consecutive patient-initiated breaths occur.

The Apnea Interval may be changed using the Extended Features menu.

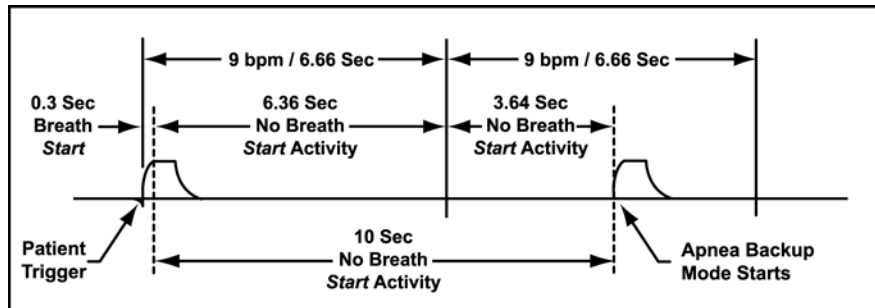

**Machine Rate 9 bpm**  
**Inspiratory Time 0.3 Seconds, Apnea Interval 10 Seconds**

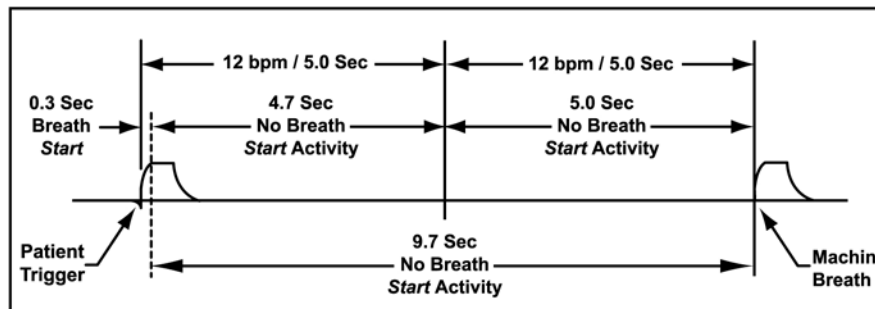

**Machine Rate 12 bpm**  
**Inspiratory Time 0.3 Seconds, Apnea Interval 10 Seconds**

## *Volume Pressure Ventilation*

---

The LTV<sup>®</sup> 1200 ventilator offers both Volume and Pressure ventilation.

When **Volume** is selected, all machine and assist breaths are Volume Control breaths. Breaths are given according to the **Tidal Volume** and **Insp. Time** controls. For more information on Volume Control breaths, see *Chapter 6 - Controls, Tidal Volume*.

When **Pressure** is selected, all machine and assist breaths are Pressure Control breaths. Breaths are given according to the **Pres. Control** and **Insp. Time** controls. For more information on Pressure Control breaths, see *Chapter 6 - Controls, Pressure Control*.

## *Bias Flow*

---

The LTV<sup>®</sup> 1200 ventilator provides a constant bias flow of 10 Lpm during exhalation to assist with patient triggering.

# Chapter 5 - USING THE CONTROLS AND INDICATORS

## Ventilator Controls

The following diagram shows how the front panel controls and displays are arranged.

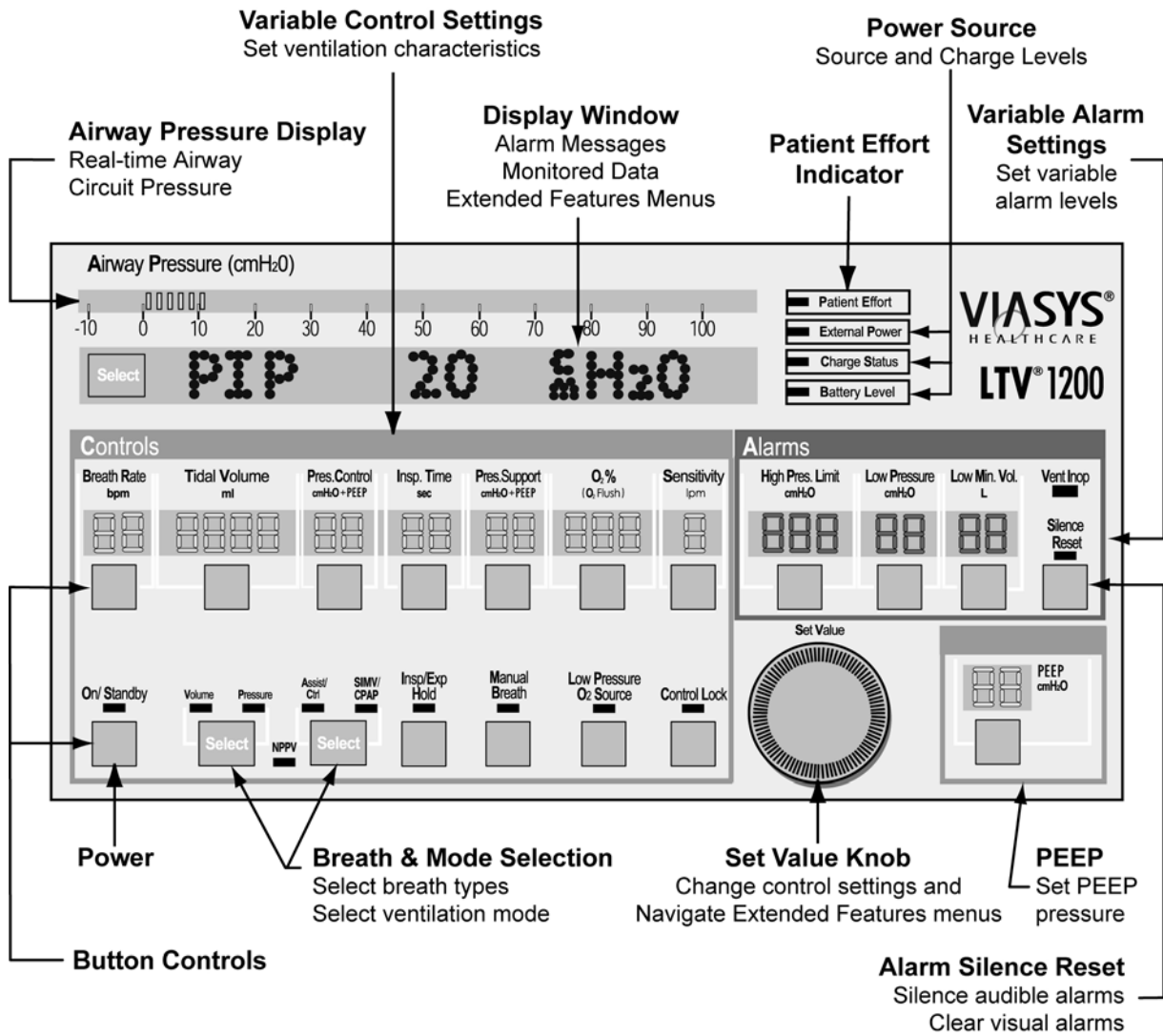

## *Setting a Control*

---

There are 5 kinds of controls on the LTV<sup>®</sup> 1200 ventilator. They are:

<b>Variable Controls</b>	Controls and alarms that have front panel displays.
<b>Buttons</b>	Push buttons that select an option or perform a function.
<b>Set Value Knob</b>	Used to set control values and navigate extended features menus.
<b>Extended Features</b>	Ventilation options that do not have front panel controls but are available through a special menu.
<b>Mechanical Controls</b>	Controls, such as Over Pressure Relief, that are hardware regulated and not operator adjustable.

The following sections describe how to set each kind of control.

### *Variable Controls*

---

#### **To set a variable control:**

- 1) Select the control by pushing the associated button. The display for the selected control will be displayed at normal brightness, but the remaining control displays will dim.
- 2) Change the control value by rotating the **Set Value** knob. Rotate clockwise to increase and counter-clockwise to decrease the value. Turning the control knob slowly will change the setting by a small increment. Turning the control knob more quickly will change the setting by a larger increment.
- 3) Deselect the control by:
  - Waiting 5 seconds, or
  - Pushing the selected button again, or
  - Selecting another control, or
  - Pushing the **Control Lock** button

When the control is deselected, all displays will return to their normal brightness. The new control value goes into effect as soon as the control is deselected.

## *Buttons*

---

Button controls do one of three things:

- Turn a feature on or off, such as Control Lock.
- Toggle between two features, such as Volume or Pressure ventilation.
- Perform a function, such as Manual Breath.

Push the button to activate the feature or change the feature state. A green LED next to the button indicates when a feature is on.

For Mode buttons, there is a second confirmation push required. To toggle between modes:

- 1) Push the mode button. The associated LED will flash for 5 seconds.
- 2) To confirm the mode change, push the mode button again while the LED is flashing. The ventilator will begin operating in the new mode.

To prevent an accidental shutdown, the ventilator requires a longer push of the **On/Standby** button to put the ventilator in the Standby state. To put the ventilator in Standby, push and hold the **On/Standby** button for 3 seconds.

## *Set Value Knob*

---

Use the **Set Value** knob to set control values and navigate extended features menus.

To change the setting for a variable control, select the control then turn the knob clockwise or counter-clockwise until the desired setting is reached.

For information on how to use the **Set Value** knob to navigate the extended features menus, see *Chapter 10 - Extended Features*.

## *Extended Features*

---

The Extended Features menus allow you to set ventilation parameters that do not have dedicated front panel controls. For information on how to use the **Set Value** knob to navigate the extended features menus, see *Chapter 10 - Extended Features*.



## *Bright, Dim and Blank Control Displays*

---

Variable controls will be displayed at normal or dimmed intensity, or may be blanked. A display will be displayed at normal intensity:

- When it is selected for change. All other displays will be dimmed.
- When it is active in the current ventilation mode. Dimmed displays are not active in the current mode.

### **NOTE**

Be sure to set any controls that may be used in Apnea Backup ventilation to appropriate values. Even though these controls are dimmed, they will be used if apnea should occur.

### **REMARQUE**

Assurez-vous de régler aux valeurs appropriées, tous les contrôles susceptibles d'être utilisés en mode ventilation de secours pour l'apnée. Même si ces contrôles sont en veilleuse, ils seront utilisés en cas d'apnée.

A display will be displayed at dimmed intensity:

- When another control is selected for change.
- When it is not active in the current ventilation mode.

A display will be blank:

- To conserve battery power while operating from battery power:
  - If no button pushes or control knob activity occurs for 60 seconds, the displays are turned off. The display window, 7-segment control displays, and LEDs are turned off. Anytime an alarm occurs, or if an alarm message is already displayed, the display window will remain active. The **Airway Pressure** display is always active.
  - To turn the displays back on, push any button or turn the control knob.
- When an option, such as oxygen blending, is not installed.
- When a control feature is not available, such as during Ventilator Checkout tests.

## *Flashing Controls*

---

Variable controls and alarms will be displayed solid or flashing. A flashing control means one of the following things:

- If you are changing a control setting, and the display flashes, you have reached a limited value for the control. Control Limiting is covered later in this section.
- If an alarm display flashes, it indicates that an alarm has occurred or is occurring. See *Chapter 9 - Ventilator Alarms* for more information on this.
- If a control display flashes, it indicates a special condition such as time termination of a pressure support breath. For more information, see *Chapter 6 - Controls*.
- If the **Control Lock** LED flashes, it indicates you have tried to change the control settings while the front panel controls are locked. For more information, see *Chapter 6 - Controls, Control Lock*.

## *Dashes*

---

If a control display is set to dashes “ - - ”, it indicates that control is turned off, or is not available in the current ventilation mode.

## *Control Limiting*

---

Variable control settings may be limited to less than their specified range for any of the following reasons:

- To prevent inverse I:E ratios of greater than 4:1
- To ensure a minimum inspiration time of 300 ms
- To ensure a minimum exhalation time of 346 ms
- To ensure a minimum initial flow of 10 lpm for Volume Controlled breaths
- To ensure a maximum initial flow of 100 lpm for Volume Controlled breaths

When you are updating a control and have reached a limited condition, the following things happen:

- The control stops updating and will remain displayed at the highest (or lowest) allowed value.
- The control display will flash.
- The displays for other controls involved in the limited condition will flash.

To set the control to a value outside the limited range, you will need to change the settings for other controls involved in the limit condition. For instance, if the **Breath Rate** is set to 12, the maximum allowed Inspiratory Time is 4.0 seconds. To set the Inspiratory Time to more than 4.0 seconds, you must first decrease the Breath Rate.

## *Control Locking*

---

The front panel controls may be locked so that settings cannot be accidentally changed. When the controls are locked, the **Control Lock** LED will be on. If you try to select or change a control while the Control Lock is on, the message **LOCKED** will be displayed in the display window and the **Control Lock** LED will flash.

Two different levels of difficulty can be set for control unlocking: Easy and Hard. The Easy unlocking method should be used when only trained personnel have access to the ventilator. The Hard method should be used when children or others may have access to the ventilator and you want to prevent accidental changes to the control settings. Easy unlocking is the default and this setting is changed using the Extended Features menus<sup>11</sup>.

### **To turn the Control Lock on:**

- 1) Push the **Control Lock** button.

The **Control Lock** LED is on whenever the front panel controls are locked.

### **If you push a button while the controls are locked:**

- 1) The **Control Lock** LED will flash.
- 2) **LOCKED** will be displayed in the display window.
- 3) The button push is ignored.

### **To turn the Control Lock off with Easy unlocking:**

- 1) Push the **Control Lock** button.

### **To turn the Control Lock off with Hard unlocking:**

- 1) Push and hold the **Control Lock** button for 3 seconds.

These controls are not affected by the Control Lock and operate even when the Control Lock is on: **Manual Breath, Silence Reset, Select.**

## **NOTE**

The **Control Lock** button also serves as an “escape” key from the Extended Menu.

## **REMARQUE**

Le bouton de verrouillage sert aussi de touche d'échappement pour quitter le menu Fonctions avancées.

## *Control Retention*

---

Once a control value is set, that value will be retained in non-volatile memory<sup>12</sup>. The settings retained in non-volatile memory may be used when the ventilator is next powered up.

---

<sup>11</sup> See *Chapter 10 - Extended Features, Control Unlock* for more information.

<sup>12</sup> Non-volatile memory is memory that is not erased when the ventilator is turned off or disconnected.

## Chapter 6 - CONTROLS

This section explains how each of the LTV<sup>®</sup> 1200 ventilator front panel controls work.

### *Assist/Control - SIMV/CPAP - NPPV*

This button toggles between **Assist/Control**, **SIMV/CPAP**, and **NPPV** modes of ventilation. Each press of the button advances or confirms your selection as follows:

- One press selects the first mode in the series (**Assist/Control**) and the associated LED flashes. A second press confirms the selection and the associated LED lights solid.
- If you press the button again, the **SIMV/CPAP** LED flashes. Pressing again confirms and causes the **SIMV/CPAP** LED to light solid green.
- Press once more to select NPPV mode and the **NPPV** LED flashes. To confirm NPPV mode you must press again but be aware that the **NPPV** LED will continue to flash until the IPAP and EPAP values have been set.
- For more information see *Procedure for NPPV Mode Set Up*, in Chapter 12 – Operating Procedure

#### **NOTE**

When **Assist/Control** is selected, the ventilator will be in Control or Assist/Control mode, depending on the Sensitivity setting.

- If **Sensitivity** is set to dashes “- -”, the ventilator will be operating in Control mode.
- If **Sensitivity** is set to any other value, the ventilator will be operating in Assist/Control mode.

When **SIMV/CPAP** is selected, the ventilator will be in SIMV or CPAP mode, depending on the **Breath Rate** setting.

- If **Breath Rate** is set to dashes “- -”, the ventilator will be operating in CPAP mode.
- If **Breath Rate** is set to any other value, the ventilator will be operating in SIMV mode.

#### **REMARQUE**

Lorsque **Aide / Contrôle** est sélectionné, le ventilateur sera en mode Contrôle ou Aide, selon le réglage de la sensibilité.

- Si la sensibilité est réglée sur Traits « - - », le ventilateur fonctionnera en mode Contrôle.
- Si la sensibilité est réglée sur toute autre valeur, le ventilateur fonctionnera en mode Aide / Contrôle.

Lorsque le mode **SIMV/CPAP** est sélectionné, le ventilateur sera en mode SIMV ou CPAP, selon le réglage du débit respiratoire.

- Si le débit respiratoire est réglé sur Traits « - - », le ventilateur fonctionnera en mode CPAP.
- Si le débit respiratoire est réglé sur toute autre valeur, le ventilateur fonctionnera en mode SIMV.

## *Breath Rate*

---

Use the **Breath Rate** control to establish the minimum rate of machine or assist breaths that the ventilator will deliver per minute.

### **To set the Breath Rate:**

- 1) Push the **Breath Rate** button.
- 2) Change the setting using the **Set Value** knob.

**Range:** “- -”, 1 - 80 bpm

### **NOTE**

When **SIMV/CPAP** is selected, the ventilator will be in SIMV or CPAP mode, depending on the **Breath Rate** setting.

- If **Breath Rate** is set to dashes “- -”, the ventilator will be operating in CPAP mode.
- If **Breath Rate** is set to any other value, the ventilator will be operating in SIMV mode.

### **REMARQUE**

Lorsque le mode **SIMV/CPAP** est sélectionné, le ventilateur sera en mode SIMV ou CPAP, selon le réglage du débit respiratoire.

- Si le débit respiratoire est réglé sur Traits « - - », le ventilateur fonctionnera en mode CPAP.
- Si le débit respiratoire est réglé sur toute autre valeur, le ventilateur fonctionnera en mode SIMV.

## *Control Lock*

---

The LTV<sup>®</sup> 1200 ventilator front panel controls may be locked so that settings are not accidentally changed. Two different levels of difficulty can be set for control unlocking: Easy and Hard. Easy unlocking is the default and this setting is changed using the Extended Features menus<sup>13</sup>. For more information on using the Control Lock, see *Chapter 5 - Control Locking*.

### **To turn the Control Lock on:**

- 1) Push the **Control Lock** button.

The **Control Lock** LED is on whenever the front panel controls are locked.

### **To turn the Control Lock off with Easy unlocking:**

- 1) Push the **Control Lock** button.

### **To turn the Control Lock off with Hard unlocking:**

- 1) Push and hold the **Control Lock** button for 3 seconds.

These controls are not affected by the Control Lock and operate even when the Control Lock is on: **Manual Breath, Silence Reset, Select**.

---

<sup>13</sup> See *Chapter 10 - Extended Features, Control Unlock* for more information.

## *High Pressure Limit*

---

Use the High Pressure Limit to establish the maximum pressure permitted the patient circuit. When this limit is reached:

- A **HIGH PRES** alarm is displayed
- The audible alarm is sounded
- Inspiration is terminated and exhalation begins

The turbine is stopped to allow the circuit pressure to evacuate when the high pressure condition persists for more than four times the set inspiratory time or more than 3.0 seconds, whichever is less.

### **To set the High Pressure Limit:**

- 1) Push the **High Pres. Limit** button.
- 2) Change the setting using the **Set Value** knob.

**Range:** 5 - 100 cmH<sub>2</sub>O

## *Inspiratory / Expiratory Hold*

---

Pushing the **Insp/Exp** (Inspiratory/Expiratory) **Hold** control button causes the ventilator to toggle between the following messages in the display window. Each push causes the next item in sequence to be displayed:

**INSP HOLD**

**EXP HOLD**

Normal monitor display

### **While INSP HOLD or EXP HOLD is displayed:**

- The **Insp/Exp Hold** control button LED will flash on and off.
- If the **Insp/Exp Hold** control button is not pushed within 60 seconds, the message will be removed and the LED will turn off.
- Pushing the **Select**, **Silence Reset** or **Control** button will return the display to normal and the LED will stop flashing.



## Inspiratory Hold

---

An Inspiratory Hold maneuver holds the inspiratory phase of a delivered breath for a duration sufficient to determine  $\Delta$  Pres pressure and static lung compliance of the patient.

### To perform the Inspiratory Hold maneuver:

- 1) Push the **Insp/Exp** (Inspiratory/Expiratory) **Hold** control button once and the display window will toggle from normal monitor display to **INSP HOLD**.
- 2) Push and hold the **Insp/Exp** (Inspiratory/Expiratory) **Hold** button during a volume inspiration.
  - The ventilator will perform an Inspiratory Hold on the next Volume breath.
  - **P Plat**<sup>14</sup> --- will be displayed in the display window.
  - All buttons that are not lockable will operate normally.
  - All buttons that are lockable will be ignored.
- 3) Continue holding the button until the Volume inspiration is completed. During the maneuver:
  - The exhalation valve will remain closed.
  - Flow will be set to 0 LPM.
  - **P Plat xxx** will be displayed in the display window, where xxx is the real time circuit pressure.
  - The breath period will remain in inspiration phase so no breath triggers are allowed.
  - **DISC/SENSE** and **HIGH PRES** alarms will terminate the maneuver.
- 4) Release the button when the pressure setting is **P Plat** (or when 6.0 seconds elapse, whichever comes first):
  - The exhalation valve will be opened and a normal exhalation phase will begin.
  - The display will cycle every 2 seconds between  **$\Delta$  Pres xxx** where xxx is the change in pressure<sup>15</sup>, **C Static xxx** where xxx is the static compliance<sup>16</sup> and **P Plat xxx** where xxx is the plateau pressure.

## NOTE

Breath period timing and apnea timing will be suspended while the maneuver is performed. As a result, the apnea alarm will not alarm during the maneuver.

## REMARQUE

La synchronisation de la période de respiration et la synchronisation de l'apnée sont interrompues pendant la manœuvre. Ainsi, l'alarme d'apnée ne se déclenche pas au cours de la manœuvre.

<b>Range:</b>	P Plat	0 - 100 cmH <sub>2</sub> O
	$\Delta$ Pres	0 - 100 cmH <sub>2</sub> O
	C Static	1 – 999 ml/cmH <sub>2</sub> O

<sup>14</sup> "P Plat" is Plateau pressure reached during Inspiratory Hold maneuver.

<sup>15</sup>  $\Delta$  Pres is calculated as P Plat Pressure – PEEP measured from previous breath.

<sup>16</sup> C Static is calculated as Set Delivered Volume /  $\Delta$  Pres.

## NOTE

The ventilator will not perform an Inspiratory Hold maneuver during Pressure Control, Pressure Support or Spontaneous breaths.

If the button is held during exhalation or any non-volume inspiration:

- The associated LED will be blinking.
- All buttons that are not lockable will operate normally.
- All buttons that are lockable will be ignored.

If the button is released before the inspiration is complete, the display will return to **INSP HOLD**.

Once the maneuver is completed, if any buttons are touched or an alarm occurs, the **Δ Pres**, **C Static** or **P Plat** display will be cleared.

After 60 seconds, the display will be cleared.

## REMARQUE

Le ventilateur n'effectue pas une manœuvre de maintien de l'inspiration au cours du contrôle de pression, du soutien de pression et de ventilations spontanées.

Lorsque le bouton est maintenu pendant l'exhalation ou toute inspiration sans volume:

- Le LED correspondant demeure allumé en continu.
- Tous les boutons non verrouillables fonctionnent normalement.
- Tous les boutons verrouillables sont ignorés.

Lorsque le bouton est relâché avant la fin de l'inspiration, l'affichage indique **INSP HOLD**.

Au terme de la manœuvre, l'actionnement d'un bouton ou le déclenchement d'une alarme entraînent l'effacement de l'affichage **Δ Pres** ou **C Static**.

L'affichage est effacée après 60 secondes.

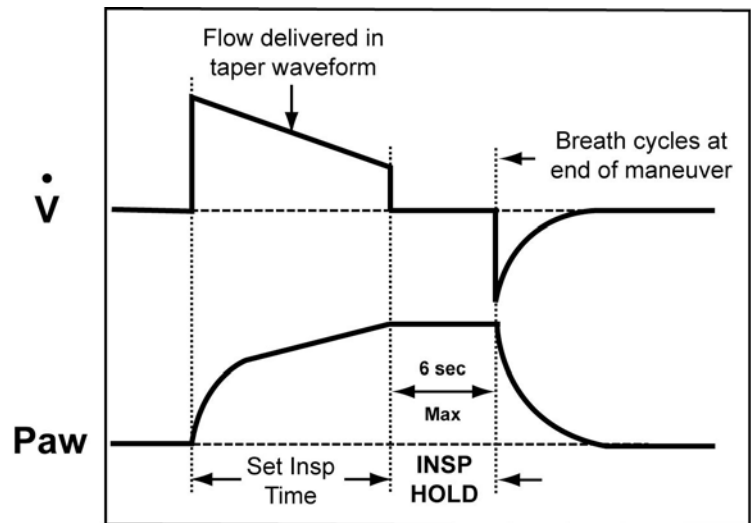

**Inspiratory Hold on Volume Control Breath**

## Expiratory Hold

---

An Expiratory Hold maneuver holds the expiratory phase of a delivered breath for a duration sufficient to determine the AutoPEEP of a patient.

### To perform the Expiratory Hold maneuver:

- 1) Push the **Insp/Exp** (Inspiratory/Expiratory) **Hold** button twice and the display window will toggle from normal monitor display to **EXP HOLD**.
- 2) Push and hold the **Insp/Exp** (Inspiratory/Expiratory) **Hold** button during a Volume or Pressure Control exhalation and the ventilator will perform an Expiratory Hold at the end of that exhalation.
  - Exhalation will proceed normally with the exhalation valve open and normal bias flow.
  - All buttons that are not lockable will operate normally.
  - All buttons that are lockable will be ignored.
  - The breath will remain in exhalation phase.
  - If a Patient Effort is detected, the maneuver will be terminated and the appropriate breath will be given.
  - **DISC/SENSE** and **HIGH PRES** alarms will terminate the maneuver.
- 3) Continue holding the button until **P Exp** with a numeric value is displayed, or the next breath is scheduled to begin, either due to **Breath Rate** or a **Manual Breath** button push. During the maneuver:
  - The exhalation valve will be closed.
  - Flow will be set to 0 LPM.
  - **P Exp xxx** will be displayed in the display window, where xxx is the real time circuit pressure<sup>17</sup>.
  - The breath will remain in expiration phase.
  - **DISC/SENSE** and **HIGH PRES** alarms will terminate the maneuver.
  - If a Patient Effort is detected, the maneuver will be terminated and the appropriate breath will be given.
- 4) Release the button (or when 6.0 seconds elapse, whichever comes first):
  - A normal inspiration phase will begin.
  - **AutoPEEP xxx** will be displayed where xxx is the autoPEEP<sup>17</sup>.
  - Any machine breath starts or apnea alarms that were held off will resume.

### NOTE

Breath period timing and apnea timing will be suspended while the maneuver is performed. As a result, the apnea alarm will not alarm during the maneuver.

### REMARQUE

La synchronisation de la période de respiration et la synchronisation de l'apnée sont interrompues pendant la manœuvre. Ainsi, l'alarme d'apnée ne se déclenche pas au cours de la manœuvre.

<b>Range:</b>	P Exp	0 - 100 cmH <sub>2</sub> O
	AutoPEEP	0 - 100 cmH <sub>2</sub> O

---

<sup>17</sup> AutoPEEP is calculated as P Exp at end of Expiratory Hold maneuver minus P Exp at end of normal exhalation (monitored PEEP).

## NOTE

The ventilator will not perform an Expiratory Hold maneuver during Pressure Support or Spontaneous breaths.

If the button is held during inspiration or during Pressure Support or spontaneous exhalation:

- The associated LED will be blinking.
- All buttons that are not lockable will operate normally.
- All buttons that are lockable will be ignored.

If the button is released before the expiration is complete, the display will return to **EXP HOLD**.

Once the maneuver is completed, if any buttons are touched or an alarm occurs, the **AutoPEEP** display will be cleared.

After 60 seconds, the **AutoPEEP** display will be cleared.

## REMARQUE

Le ventilateur n'effectue pas une manœuvre de maintien de l'expiration au cours du soutien de pression ou de ventilations spontanées.

Lorsque le bouton est maintenu pendant l'inspiration, le soutien de pression ou des ventilations spontanées:

- Le LED correspondant demeure allumé en continu.
- Tous les boutons non verrouillables fonctionnent normalement.
- Tous les boutons verrouillables sont ignorés.

Lorsque le bouton est relâché avant la fin de l'expiration, l'affichage indique **EXP HOLD**.

Au terme de la manœuvre, l'actionnement d'un bouton ou le déclenchement d'une alarme entraînent l'effacement de l'affichage **AutoPEEP**.

L'affichage **AutoPEEP** est effacée après 60 secondes.

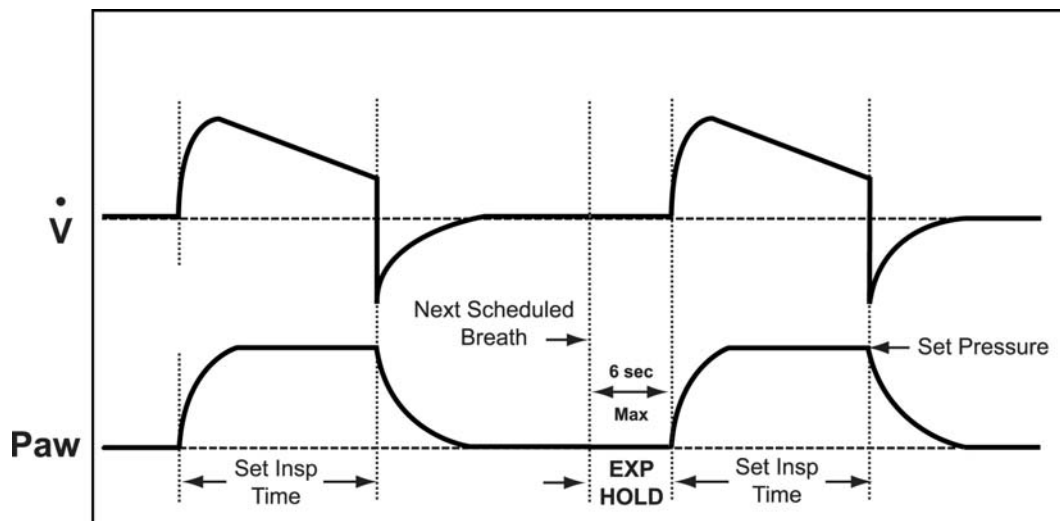

**Expiratory Hold on Pressure Control Breath**

## *Inspiratory Time*

---

This control sets the length of the inspiratory period for Volume Controlled and Pressure Controlled breaths.

The **Insp. Time** setting, along with the **Volume** control setting are used to determine the peak flow for Volume controlled breaths. While the Inspiratory Time is being updated, the Calculated Peak Flow will be displayed in the display window.

### **To set the Inspiratory Time:**

- 1) Push the **Insp. Time** button.
- 2) Change the setting using the **Set Value** knob.

**Range:** 0.3 - 9.9 sec

## *Low Minute Volume*

---

The Low Minute Volume alarm sets the minimum expected exhaled Minute Volume. The exhaled Minute Volume is recalculated after every breath. If the Minute Volume does not meet or exceed the Low Minute Volume setting:

- A **LOW MIN VOL** alarm is displayed
- The audible alarm is sounded

### **To set the Low Minute Volume alarm:**

- 1) Push the **Low Min. Vol.** button.
- 2) Change the setting using the **Set Value** knob.

**Range:** Off, 0.1 - 99 L

### **WARNING**

**Low Minute Volume Control Settings** - The **Low Min. Vol.** control should be set to its highest clinically appropriate value. If there is a clinical need to set the Low Minute Volume alarm to lower values or off (“- - -”), perform a clinical assessment to determine if an alternative monitor (i.e. a Pulse Oxymeter with an audible alarm, or a Cardio Respiratory Monitor) should be used.

### **AVERTISSEMENT**

**Réglages du contrôle de volume bas par minute** - Le contrôle du volume bas par minute doit être ajusté à la plus haute valeur clinique appropriée. Si l’alarme de volume bas par minute doit être ajustée à des valeurs inférieures ou mise à l’arrêt (“- - -”) pour satisfaire aux besoins cliniques, effectuer une évaluation clinique afin de déterminer si l’utilisation d’un autre moniteur (c.-à-d., sphygmo-oxymètre muni d’une alarme sonore ou un moniteur cardio-respiratoire) s’avère pertinente.

## Low Pressure

---

The Low Pressure alarm can be set to apply to All breaths or to Volume Control and Pressure Control breaths only. (For information on selecting breath types, see *Chapter 10 - Extended Features, Low Peak Pressure Alarm.*) The Low Pressure alarm establishes the minimum expected circuit pressure for the selected breath types. If the circuit pressure does not meet or exceed the Low Pressure setting:

- A **LOW PRES** alarm is displayed
- The audible alarm is sounded

### To set the Low Pressure alarm:

- 1) Push the **Low Pressure** button.
- 2) Change the setting using the **Set Value** knob.

**Range:** “- -”, 1 - 60 cmH<sub>2</sub>O

### **WARNING**

**Patient Circuit Accessories** - The use of accessories such as Speaking Valves, Heat-Moisture Exchangers and Filters create additional patient circuit resistance and in the event of a disconnection, may impede the generation of a Low Pressure alarm. Ensure that the Low Pressure alarm settings accommodate these types of accessories when used in combination with patient circuits.

### **AVERTISSEMENT**

**Accessoires du circuit du patient** - L'utilisation d'accessoires tels que les membranes vocales, les échangeurs thermohydriques et les filtres, produit une résistance additionnelle dans le circuit de patient et en cas de débranchement, elle risque d'empêcher la génération de l'alarme de basse pression. S'assurer que les paramètres de l'alarme de basse pression s'adaptent à ces types d'accessoires lorsqu'ils sont utilisés avec les circuits du patient.

## Low Pressure O<sub>2</sub> Source

---

When selected, this option allows oxygen to be supplied from a low pressure / low flow oxygen source such as an oxygen concentrator or line mounted flow meter. Oxygen from the low pressure source is mixed with air inside the ventilator. The O<sub>2</sub> percent delivered to the patient is determined by the O<sub>2</sub> inlet flow and the total minute volume and is not regulated by the ventilator. Use the Input O<sub>2</sub> Flow chart (page 6-15) to determine the correct O<sub>2</sub> flow for the desired FIO<sub>2</sub>.

- When the Low Pressure O<sub>2</sub> Source option is selected and a high O<sub>2</sub> pressure source is attached to the ventilator, an Automatic High O<sub>2</sub> Switch Over safety response generates a **HIGH O<sub>2</sub> PRES** alarm, switches the ventilator to High Pressure O<sub>2</sub> Source mode and sets the percentage of oxygen to be delivered in the gas flow to 21%.

When the Low Pressure O<sub>2</sub> Source option is not selected, a high pressure oxygen source is expected, and oxygen blending is done within the ventilator. The ventilator expects an oxygen source with a pressure of 40 - 80 PSIG. The O<sub>2</sub> percent delivered to the patient is determined by the O<sub>2</sub> % (O<sub>2</sub> Flush) setting on the ventilator front panel.

### To toggle the state of the Low Pressure O<sub>2</sub> Source:

- 1) Push and hold the **Low Pressure O<sub>2</sub> Source** button for three (3) seconds.
  - While the **Low Pressure O<sub>2</sub> Source** button is being held, the associated LED will be flashing
  - When the Low Pressure O<sub>2</sub> Source is selected, the associated LED will be on continually

### While Low Pressure O<sub>2</sub> Source is on:

---

- The O<sub>2</sub> Inlet Pressure Low alarm is inactive.
- The O<sub>2</sub> Pressure High alarm is set to activate at > 10 PSIG.
- The **O<sub>2</sub> % (O<sub>2</sub> Flush)** display will display dimmed dashes and O<sub>2</sub> % cannot be set.
- Oxygen inlet flow must be set to obtain the desired oxygen percentage.

### **WARNING**

**Inspired Oxygen (FIO<sub>2</sub>) Concentration** – If the patient has a variable respiratory rate, his/her minute ventilation will fluctuate. If exact concentrations of inspired oxygen (FIO<sub>2</sub>) are required to be delivered to the patient, it is recommended that an accurate oxygen analyzer with alarms be used.

### **AVERTISSEMENT**

**Concentration d'oxygène inspiré (FIO<sub>2</sub>)** – Si la fréquence respiratoire du patient est variable, sa ventilation-minute va fluctuer. Lorsqu'une concentration exacte d'oxygène inspiré (FIO<sub>2</sub>) est nécessaire pour une transmission au patient, il est recommandé d'utiliser un analyseur de niveau d'oxygène<sup>2</sup> précis, comportant des alarmes.



### Low Pressure O<sub>2</sub> Source (cont.)

#### **NOTE**

The Oxygen Inlet High Pressure alarm at 10 PSIG is only active when Low Pressure O<sub>2</sub> Source is on.

#### **REMARQUE**

L'alarme de haute pression d'entrée de l'oxygène réglée sur 10 PSIG ne sera active que lorsque la source de basse pression O<sub>2</sub> est activée.

#### **While Low Pressure O<sub>2</sub> Source is off:**

---

- The O<sub>2</sub> Inlet Pressure Low alarm is set to activate at less than 35 PSIG.
- The O<sub>2</sub> Pressure High alarm is set to activate at greater than 85 PSIG.
- The **O<sub>2</sub>% (O<sub>2</sub> Flush)** may be used to set the desired percentage of oxygen.

#### **NOTE**

The Oxygen Inlet High Pressure alarm at 85 PSIG and Oxygen Inlet Low Pressure alarm at 35 PSIG are only active when Low Pressure O<sub>2</sub> Source is off and the **O<sub>2</sub> % (O<sub>2</sub> Flush)** setting is greater than 21%.

#### **REMARQUE**

L'alarme de haute pression d'entrée de l'oxygène réglée sur 85 PSIG, et l'alarme de basse pression d'entrée de l'oxygène réglée sur 35 PSIG ne seront actives que lorsque la source de basse pression O<sub>2</sub> est désactivée et que le réglage du **O<sub>2</sub> % (Flush O<sub>2</sub>)** est supérieur à 21%.

#### **When the Oxygen Blending option is not installed:**

---

The **Low Pressure O<sub>2</sub> Source** button is only active when the oxygen blending option is installed. Oxygen may still be supplied through the low pressure, low flow inlet, but the **Low Pressure O<sub>2</sub> Source** button, **O<sub>2</sub> % (O<sub>2</sub> Flush)** control, and the Oxygen Inlet Pressure alarms are inactive.

## Low Pressure O<sub>2</sub> Source (cont)

### Low Pressure O<sub>2</sub> Blending:

Oxygen will be applied through the low pressure, low flow inlet. Use this chart to determine the approximate O<sub>2</sub> flow required to deliver the desired FIO<sub>2</sub>.

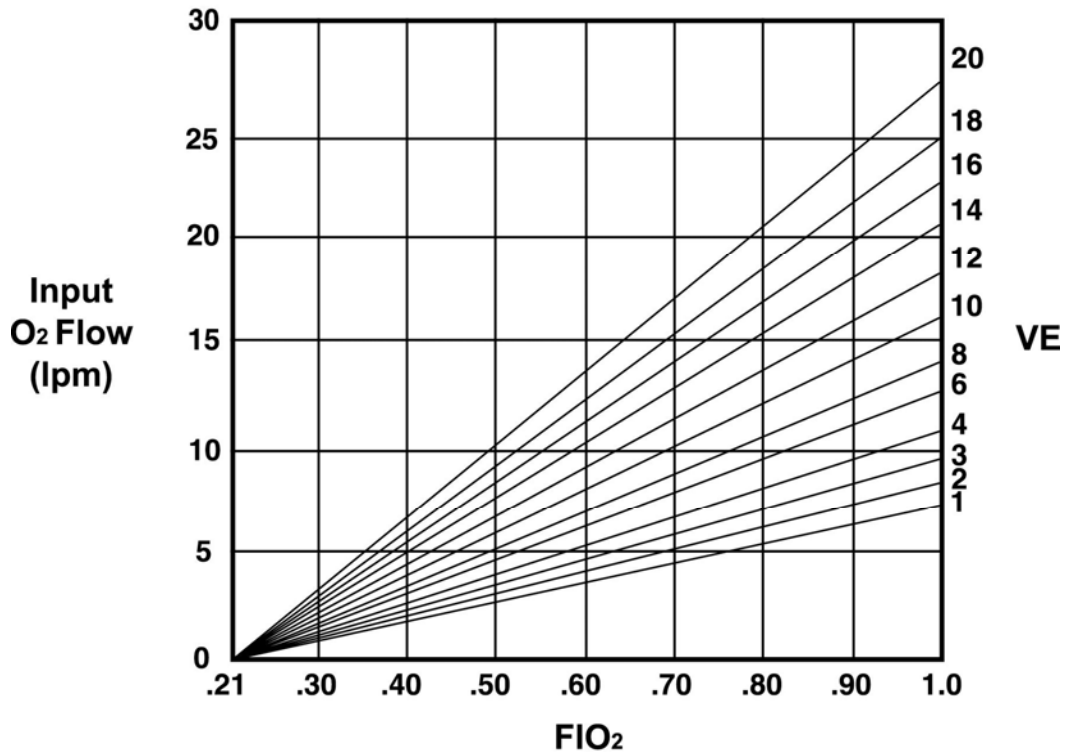

### **⚠ WARNING**

**Inspired Oxygen (FIO<sub>2</sub>) Concentration** – If the patient has a variable respiratory rate, his/her minute ventilation will fluctuate. If exact concentrations of inspired oxygen (FIO<sub>2</sub>) are required to be delivered to the patient, it is recommended that an accurate oxygen analyzer with alarms be used.

### **⚠ AVERTISSEMENT**

**Concentration d'oxygène inspiré (FIO<sub>2</sub>)** – Si la fréquence respiratoire du patient est variable, sa ventilation-minute va fluctuer. Lorsqu'une concentration exacte d'oxygène inspiré (FIO<sub>2</sub>) est nécessaire pour une transmission au patient, il est recommandé d'utiliser un analyseur de niveau d'oxygène précis, comportant des alarmes.

Low Pressure O<sub>2</sub> Source (cont.)

**To determine the required O<sub>2</sub> input flow:**

- 1) Find the desired FIO<sub>2</sub> (bottom of chart).
- 2) Calculate the patient's minute ventilation rate by using the following formula: Tidal volume x breath rate.
- 3) Follow the FIO<sub>2</sub> up to the applicable slanted VE (minute volume) line (right side of chart).
- 4) Read across horizontally to the left side of chart to the required Input O<sub>2</sub> Flow (lpm).

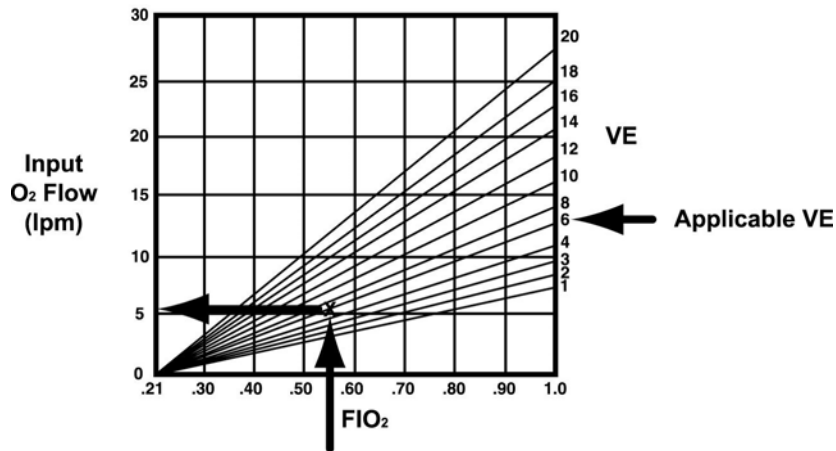

**Example - To determine the required O<sub>2</sub> input flow**

**To determine the delivered O<sub>2</sub> concentration:**

- 1) Find the Input O<sub>2</sub> Flow (left side of chart).
- 2) Follow the Input O<sub>2</sub> Flow across horizontally to the right to the applicable slanted VE (minute volume) line.
- 3) Read down to the FIO<sub>2</sub> (bottom of chart).

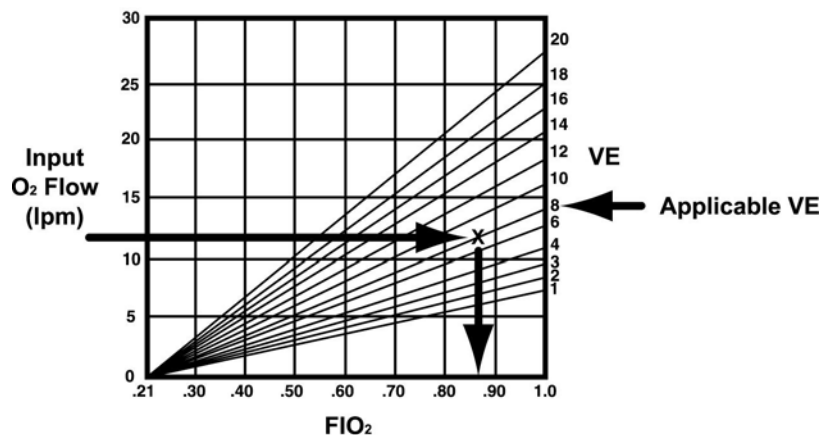

**Example - To determine the delivered O<sub>2</sub> concentration**

## *Manual Breath*

---

Use the **Manual Breath** button to deliver one (1) Machine breath. The breath will be a Volume Control or Pressure Control breath as defined by the current ventilator settings. The **Manual Breath** LED is on during the Manual Breath inspiration.

**To deliver a Manual breath:**

- 1) Push the **Manual Breath** button.

The **Manual Breath** button is only active during exhalation.

## *O<sub>2</sub> % (O<sub>2</sub> Flush)*

---

The **O<sub>2</sub>% (O<sub>2</sub> Flush)** button is a dual function control (O<sub>2</sub> % and O<sub>2</sub> Flush).

- When being used to set the percentage of oxygen delivered by the ventilator through the oxygen blending system (O<sub>2</sub>%), push and release the **O<sub>2</sub>% (O<sub>2</sub> Flush)** button, as described below.
- When being used to elevate the delivered FIO<sub>2</sub> to 100% for a preset period of time (O<sub>2</sub> Flush), push and hold the **O<sub>2</sub>% (O<sub>2</sub> Flush)** button for 3 seconds, as described in *Chapter 10 - Extended Features, O<sub>2</sub> Flush*
- .

The **O<sub>2</sub>% (O<sub>2</sub> Flush)** control establishes the percentage of oxygen to be delivered through the oxygen blending system. Oxygen blending requires a high pressure oxygen source and is active only when Low Pressure O<sub>2</sub> Source is not selected<sup>18</sup>. When Low Pressure O<sub>2</sub> Source is selected, this control is displayed as dashes “---” and may not be modified.

### **To set the percentage of oxygen delivered by the ventilator:**

- 1) Push and release the **O<sub>2</sub>% (O<sub>2</sub> Flush)** button.
- 2) Change the setting using the **Set Value** knob.

**Range:** 21 - 100 %

### **WARNING**

**Inspired Oxygen (FIO<sub>2</sub>) Concentration** – If the patient has a variable respiratory rate, his/her minute ventilation will fluctuate. If exact concentrations of inspired oxygen (FIO<sub>2</sub>) are required to be delivered to the patient, it is recommended that an accurate oxygen analyzer with alarms be used.

### **AVERTISSEMENT**

**Concentration d'oxygène inspiré (FIO<sub>2</sub>)** – Si la fréquence respiratoire du patient est variable, sa ventilation-minute va fluctuer. Lorsqu'une concentration exacte d'oxygène inspiré (FIO<sub>2</sub>) est nécessaire pour une transmission au patient, il est recommandé d'utiliser un analyseur de niveau d'oxygène<sup>2</sup> précis, comportant des alarmes.

### **CAUTION**

**Oxygen Supply Contamination** - The accuracy of the oxygen delivery capabilities of LTV<sup>®</sup> 1200 ventilator can be compromised by foreign debris contamination in the oxygen supply system. To reduce the risk of airborne contaminants entering the ventilator, ensure that any oxygen supply connected to the ventilator is clean, properly filtered<sup>19</sup> and that the ventilator's O<sub>2</sub> Inlet Port Cap is securely installed on the O<sub>2</sub> Inlet Port whenever the ventilator is not connected to an external oxygen supply.

<sup>18</sup> For information on using a low pressure, low flow source, see *Low Pressure O<sub>2</sub> Source* in this section.

<sup>19</sup> In addition to the existing internal O<sub>2</sub> Inlet filter, P/N 14313, an External, In-Line Oxygen Filter (P/N 14470) is available from Pulmonetic Systems, Inc.

## O<sub>2</sub>% (O<sub>2</sub> Flush) (cont)

### **ATTENTION**

**Contamination de la réserve d'oxygène** — La précision de la capacité d'alimentation en oxygène des ventilateur 1200 LTV<sup>®</sup> peut être compromise par la présence de corps étrangers dans le système d'alimentation en oxygène. Afin de diminuer le risque de présence d'agents contaminants atmosphériques dans le ventilateur, assurez-vous que la réserve d'oxygène reliée au ventilateur est propre et filtrée de manière adéquate<sup>21</sup>, et que le bouchon de l'orifice d'alimentation en oxygène est correctement installé à chaque fois que le ventilateur n'est pas relié à une source d'oxygène externe.

### **NOTE**

The Oxygen Inlet High Pressure alarm at 85 PSIG and Oxygen Inlet Low Pressure alarm at 35 PSIG are only active when Low Pressure O<sub>2</sub> Source is off and the **O<sub>2</sub>% (O<sub>2</sub> Flush)** setting is greater than 21%.

### **REMARQUE**

L'alarme de haute pression d'entrée de l'oxygène réglée sur 85 PSIG, et l'alarme de basse pression d'entrée de l'oxygène réglée sur 35 PSIG ne seront actives que lorsque la source de basse pression O<sub>2</sub> est désactivée et que le réglage du **O<sub>2</sub>% (O<sub>2</sub> Flush)** est supérieur à 21%.

#### **When the Oxygen Blending option is not enabled:**

O<sub>2</sub>% (O<sub>2</sub> Flush) is only available when the oxygen blending option is enabled. Oxygen may still be supplied through the low pressure low flow inlet<sup>20</sup>, but the **Low Pressure O<sub>2</sub> Source** and **O<sub>2</sub>% (O<sub>2</sub> Flush)** controls, and the Oxygen Inlet Pressure alarms are inactive.

<sup>20</sup> See *Low Pressure O<sub>2</sub> Source* in this chapter for more information.

## On/Standby

---

This button switches the LTV<sup>®</sup> 1200 ventilator between Standby and On.

When the ventilator is on, the **On/Standby** LED will be on. The ventilator will operate on external power if it is available, or internal battery, if there is no external power or the external power source is depleted. The internal battery will be charged from the external power source while the ventilator is operating on external power.

When the ventilator is in Standby, the **On/Standby** LED will be off, however, the internal battery will continue to charge.

### To turn the ventilator on from the Standby state:

- 1) Push the **On/Standby** button.

If the Patient Query feature is enabled/on when the ventilator is powered up, ventilation and alarm activation are suspended and the message **SAME PATIENT** is displayed (see *Presets* in Chapter 10 - Extended Features).

- To enable the suspended alarms and begin ventilation with the settings in use during the last power cycle, press the **Select** button while **SAME PATIENT** is displayed

OR

- To enable the suspended alarms and begin ventilation with Presets values appropriate for a new patient, turn the **Set Value** knob until **NEW PATIENT** is displayed and press the **Select** button. Then turn the **Set Value** knob until the desired patient type is displayed (**INFANT**, **PEDIATRIC** or **ADULT**) and press the **Select** button (see *LTV<sup>®</sup> 1200 Presets Table* in Chapter 10 – Extended Features for detailed settings information)
  - Turning the **Set Value** knob until **EXIT** is displayed and pressing the **Select** button returns the ventilator to the **SAME PATIENT** menu option/message

If no controls are activated for three (3) seconds while either the **SAME PATIENT** or **NEW PATIENT** options are being displayed, an audible alert sounds. Activation of any control resets the 3 second delay of the audible alert.

If the Patient Query feature is disabled/off when the ventilator is powered up and passes POST, it will begin ventilation (appropriate alarms enabled) using the settings in use during the last power cycle.

To prevent autocycling, the Leak Compensation feature (if enabled/on) is suspended during the first 30 seconds of operation.

To prevent nuisance alarms, the **LOW MIN VOL** alarm (Low Minute Volume) is suspended for the first 20 seconds and the **HIGH f** alarm (High Breath Rate) is suspended for the first 60 seconds of operation.

### To put the ventilator into Standby:

- 1) Push and hold the **On/Standby** button for 3 seconds.
- 2) An **Inop** alarm will occur. To cancel the Inop alarm, push the **Silence Reset** button.
  - Verify a confirming audible chirp occurs after the alarm is silenced.
- 3) The **Vent Inop** LED will remain lit for a minimum of 5 minutes.

## PEEP Control

---

The PEEP control establishes the Positive End Expiratory Pressure.

### To set the PEEP:

- 1) Push the **PEEP** control button.
- 2) Change the setting using the **Set Value** knob.

**Range:** 0 – 20 cmH<sub>2</sub>O

### The LTV<sup>®</sup> 1200 has PEEP Compensated Pressure Support and Pressure Control.

On the left waveform (breath), the ventilator is set to deliver Pressure Support (or Pressure Control) of 20 cmH<sub>2</sub>O with no PEEP. The “span” or “delta” is 20 cmH<sub>2</sub>O.

On the right waveform, the vent is set to deliver Pressure Support (or Pressure Control) of 20 cmH<sub>2</sub>O. Note that 5 cmH<sub>2</sub>O of PEEP have been added. This ventilator “compensates” for the added PEEP by automatically increasing the Pressure Support (or Pressure Control) in order to maintain the same “span” or “delta” of 20 cmH<sub>2</sub>O.

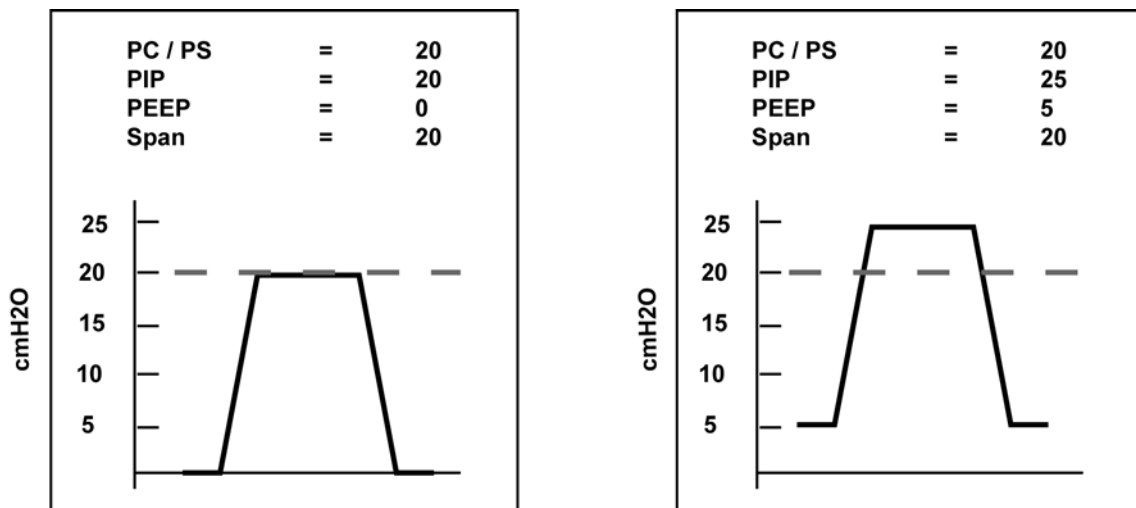

### To view the measured PEEP in the display window:

- 1) Use the **Select** button to display the measured PEEP in the display window.

## PEEP Control in NPPV Mode

---

When NPPV mode is selected, the PEEP control is used to set the EPAP value.



## Pressure Control

This control establishes the target pressure above the PEEP setting for Pressure Control breaths.

### NOTE

Pressure Control and Pressure Support breaths do compensate for PEEP. Delivered pressure is controlled by the Pressure Control setting and is affected by the PEEP setting. For example, a Pressure Control setting of 20cmH<sub>2</sub>O and a PEEP setting of 10cmH<sub>2</sub>O results in a Peak Inspiratory Pressure (PIP) of 30cmH<sub>2</sub>O.

### REMARQUE

Le contrôle de la pression et la pression de support des respirations compensent la PEP. La pression administrée est contrôlée par le réglage du contrôle de la pression et elle dépend du réglage PEP. Par exemple, un réglage du contrôle de la pression de 20 cmH<sub>2</sub>O et un réglage PEP de 10 cmH<sub>2</sub>O donnent une pression inspiratoire maximale (P<sub>I</sub>max) de 30 cmH<sub>2</sub>O.

The inspiratory time for the Pressure Control breath is determined by the Inspiratory Time setting.

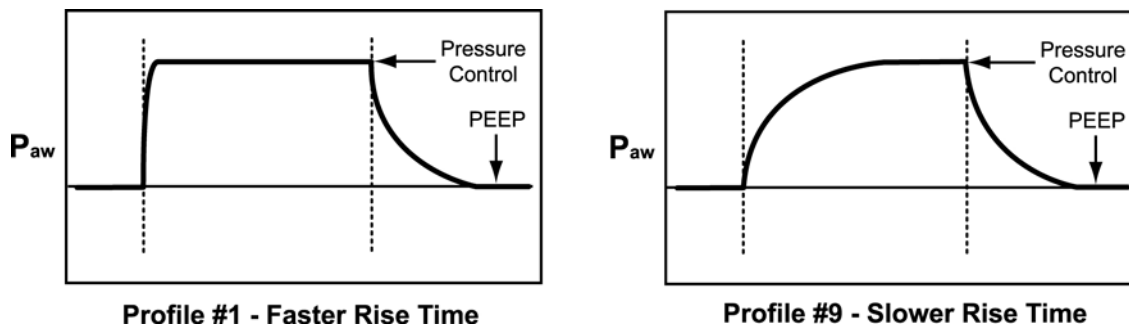

The ventilator controls inspiratory flow to maintain the set circuit pressure for the set time.

#### To set the Pressure Control level:

- 1) Push the **Pres. Control** button.
- 2) Change the setting using the **Set Value** knob.

#### To select Pressure Control:

- 1) Toggle the **Volume Pressure** mode to select **Pressure** ventilation<sup>21</sup>.

**Range:** 1 - 99 cmH<sub>2</sub>O

Flow Termination for Pressure Control breaths may be enabled under Extended Features<sup>22</sup>. If flow termination is enabled, the **Pres. Control** display will flash briefly after each flow terminated breath. The Rise Time profile for Pressure Control breaths may be selected under Extended Features<sup>23</sup>.

<sup>21</sup> See *Chapter 6 - Controls* for more information on how to select Pressure ventilation.

<sup>22</sup> See *Chapter 10 - Extended Features* for how to set the Variable Flow Termination percentage and enable Flow Termination for Pressure Control breaths.

<sup>23</sup> See *Chapter 10 - Extended Features* for how to set the Flow Rise Time profile.

## Pressure Support

This control establishes the target pressure above the PEEP setting for Pressure Support patient breaths. If Pressure Support is set to dashes "--", all patient breaths will be given as Spontaneous breaths. Inspiratory flow for Pressure Support and Spontaneous breaths is controlled to meet the patient demand.

### NOTE

Pressure Control and Pressure Support breaths do compensate for PEEP. Delivered pressure is controlled by the Pressure Support setting and is affected by the PEEP setting. For example, a Pressure Control setting of 20cmH<sub>2</sub>O and a PEEP setting of 10cmH<sub>2</sub>O results in a Peak Inspiratory Pressure (PIP) of 30cmH<sub>2</sub>O.

### REMARQUE

Le contrôle de la pression et la pression de support des respirations compensent la PEP. La pression administrée est contrôlée par le réglage du contrôle de la pression et elle dépend du réglage PEP. Par exemple, un réglage du contrôle de la pression de 20 cmH<sub>2</sub>O et un réglage PEP de 10 cmH<sub>2</sub>O donnent une pression inspiratoire maximale (PI<sub>max</sub>) de 30 cmH<sub>2</sub>O.

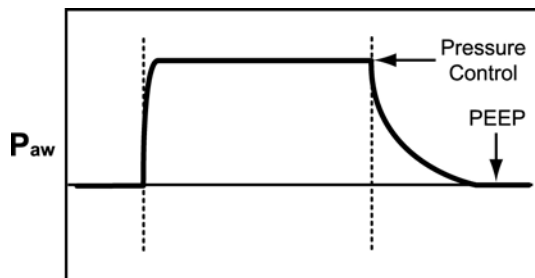

Profile #1 - Faster Rise Time

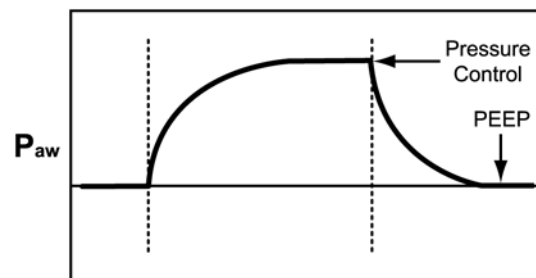

Profile #9 - Slower Rise Time

#### To set Pressure Support:

- 1) Push the **Pres. Support** button.
- 2) Change the setting using the **Set Value** knob.

**Range:** "--", 1 - 60 cmH<sub>2</sub>O

Pressure Support breaths may be terminated by flow or by time.

**Flow Termination:** Pressure Support breaths are flow terminated when the flow decreases to a set percentage of the peak flow<sup>24</sup> delivered for that breath.

**Time Termination:** Pressure Support breaths are time terminated<sup>25</sup> when the inspiratory time exceeds two breath periods, or when the inspiratory time exceeds the set Time Termination Limit<sup>26</sup> before the flow termination criteria is reached. The **Pres. Support** display will flash briefly after each time terminated breath.

The Rise Time profile for Pressure Support breaths may be selected under Extended Features<sup>26</sup>.

## Pressure Support in NPPV Mode

When NPPV mode is selected, the **Pres. Support** control is used to set the IPAP value.

<sup>24</sup> See Chapter 10 - Extended Features to set the Variable Flow Termination for Pressure Support breaths.

<sup>25</sup> Only Pressure Support breaths are flow and/or time terminated (Time Termination must be enabled).

<sup>26</sup> See Chapter 10 - Extended Features to set the Variable Time Termination or Flow Rise Time profile.

## Select

---

Use this button to change the monitor in the display window and to select items in the Extended Feature menus.

### Monitored Data:

---

The monitored data displays may be automatically or manually scrolled.

#### To cycle through the available monitored data automatically from a halted scan:

- 1) Push the monitor **Select** button twice within 0.3 sec.
- 2) Pushing the **Select** button once while scan is active will halt scanning and the currently displayed data will remain in the display window.
- 3) Each time you push the button once, the next data item in the list will be displayed.
- 4) To resume scan, push the **Select** button twice.

The monitored data is displayed for 3 seconds.

### Extended Features:

---

#### To enter the Extended Features menu:

- 1) Push and hold the **Select** button for 3 seconds.

The first Menu Item will be displayed, for example: **ALARM OP**

For more information on how to use the Extended Features menu, see *Chapter 10 - Extended Features*.

## *Sensitivity*

---

Use the **Sensitivity** control to establish the threshold level to allow the patient to flow trigger Assist and Patient breaths.

**A flow trigger occurs when:**

- The **Sensitivity** is set to any value from 1 to 9,
- *And* the ventilator is in exhalation phase,
- *And* the minimum exhalation time has expired,
- *And* the flow is greater than or equal to the **Sensitivity** setting.

The **LEAK** measurement displayed in the **RT XDCR DATA** menu can be used to help select an appropriate sensitivity value. Typically, the sensitivity value is set higher than the displayed **LEAK** measurement. For instance, if the **LEAK** measurement were up to 2.53, a minimum sensitivity of three (3) would be appropriate.

Backup pressure triggers are enabled when the setting is any value other than a dash “-”.

**A backup pressure trigger occurs when:**

- The **Sensitivity** is set to any value from 1 to 9,
- *And* the ventilator is in exhalation phase,
- *And* the minimum exhalation time has expired,
- *And* the airway pressure drops below -3 cmH<sub>2</sub>O.

**When a trigger is detected, the Patient Effort LED is illuminated briefly.**

### **NOTE**

Triggers are disabled when the **Sensitivity** setting is set to “-”.

### **REMARQUE**

Les amorces sont désactivées lorsque le réglage de la sensibilité est réglé sur « - ».

**To set Sensitivity:**

- 1) Push the **Sensitivity** button.
- 2) Change the setting using the **Set Value** knob.

**Range:** 1 - 9, “-”, 1 is the most sensitive, 9 is the least sensitive and “-“ is off.

## *Set Value Knob*

---

Use the **Set Value** knob to establish control values and navigate extended features menus.

### **Variable Controls:**

---

#### **To change the setting for a variable control:**

- 1) Push the button for the control to be modified.
- 2) Turn the **Set Value** knob clockwise to increase the value, or
- 3) Turn the **Set Value** knob counter-clockwise to decrease the value.

To change the setting by small increments, turn the knob slowly. To change the setting by larger increments, turn the knob more quickly.

### **Extended Features:**

---

#### **To navigate through a list of items in an Extended Features menu:**

- 1) Turn the **Set Value** knob clockwise to display the next menu item, or
- 2) Turn the **Set Value** knob counter-clockwise to display the previous menu item.

## *Silence Reset*

---

Use this button to silence an alarm for 60 seconds, to reset an alarm, to start a 60 second preemptive silence period, and to permanently silence the **Vent Inop** and **Standby** alarms. Two important definitions for understanding how the **Silence Reset** button works:

- **Active alarm:** An alarm for which the condition currently exists.
- **Inactive alarm:** An alarm that has occurred, but for which the condition no longer exists.

### **Silencing and Clearing Alarms:**

---

#### **To silence an active alarm for 60 seconds:**

- 1) Push the **Silence Reset** button. The audible alarm will be silenced for 60 seconds. Once the silence period expires, the audible alarm will resume sounding.

#### **To clear an inactive alarm:**

- 1) Push the **Silence Reset** button. The visual alarm displays will be cleared.

#### **To cancel an active alarm:**

- 1) Push the **Silence Reset** button twice. The audible alarm will be silenced and the visual alarm displays will be cleared and the silence period will be terminated.

### **Preemptive Silence Period**

---

#### **To start a preemptive silence period:**

- 1) Push the **Silence Reset** button. A 60 second silence period will begin. For any alarms that occur during the silence period, the visual displays will flash, but the audible alarm will remain silenced until the end of the silence period.

### **Vent Inop and Standby alarms:**

---

#### **To silence the Vent Inop or Standby alarm:**

- 1) Push the **Silence Reset** button. The audible alarm will be permanently silenced, but the **Vent Inop** LED will remain lit for a minimum of 5 minutes. This does not adversely affect battery life.

## Tidal Volume

---

Use the **Tidal Volume** control to establish the volume of gas which the ventilator will produce and deliver during Volume Controlled breaths. Flow is delivered in a taper waveform over the set Inspiratory Time. The peak flow is calculated based on the Tidal Volume and Inspiratory Time with a maximum flow of 100 lpm and a minimum flow of 10 lpm. Flow is decelerated from the calculated peak flow to 50% of the calculated peak flow.

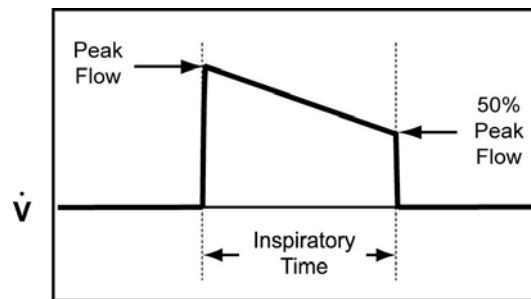

**Taper Waveform**

While the Tidal Volume is being updated, the Calculated Peak Flow is displayed in the display window.

### To set the Tidal Volume:

- 1) Push the **Tidal Volume** button.
- 2) Change the setting using the **Set Value** knob.
- 3) Push the **Tidal Volume** button again to deselect the setting and accept the new value.

**Range:** 50 - 2000 ml

### NOTE

Be sure that **Volume** ventilation is selected.

### REMARQUE

Assurez-vous que le **volume** de ventilation est sélectionné.

## *Volume Pressure Mode*

---

Use this button to toggle between **Pressure** control and **Volume** control modes of ventilation.

**To toggle between the modes:**

- 1) Push the mode button once. The associated LED will flash for 5 seconds.
  - 2) To confirm the mode change, push the mode button again while the LED is flashing.
- The ventilator will begin operating in the new mode as soon as the mode change is complete.





## Chapter 7 - DISPLAYS AND INDICATORS

This section describes each of the LTV<sup>®</sup> 1200 ventilator front panel displays.

### *Airway Pressure*

---

The **Airway Pressure** display is a bar of 60 LEDs that is used to display the real-time airway circuit pressure. The displayed pressures range from -10 cmH<sub>2</sub>O to 108 cmH<sub>2</sub>O in increments of 2 cmH<sub>2</sub>O. In addition to displaying the real-time airway pressure, a single LED is lit showing the Peak Inspiratory Pressure of the previous breath.

### *Display Window*

---

The display window is a 12 character, 5x7 dot matrix array that is used to display alarms, monitored data, and Extended Features menu items. Messages are displayed with the following priorities (highest to lowest):

- Alarm Messages<sup>27</sup>
- Extended Features Menu Items<sup>28</sup>
- Monitored Data<sup>29</sup>

### *Indicators*

---

The following section describes the purpose of the LED indicators on the front panel that do not have associated front panel controls.

---

<sup>27</sup> See *Chapter 9 - Ventilator Alarms* and *Chapter 6 - Controls, Silence Reset* for more information on how to clear alarm displays.

<sup>28</sup> See *Chapter 10 - Extended Features* for more information on how to use the Extended Features Menus.

<sup>29</sup> See *Chapter 8 - Monitored Data* and *Chapter 6 - Controls, Select* for more information on displaying monitors.

## Battery Level

---

The **Battery Level** indicator shows the level of available internal battery power while running from the internal battery. When the ventilator is running from an external power source, the **Battery Level** indicator is off. When running from the internal battery at the nominal settings shown below, the indicator shows the following levels:

Alarm	LED Color	Battery Level	Approximate Battery Time (Total time: 60 mins)
--	Green	Internal battery level is acceptable	45 minutes
<b>BAT LOW</b>	Amber	Internal battery level is low	10 minutes
<b>BAT EMPTY</b>	Red	Internal battery level is critically low	5 minutes

### Nominal Settings

Mode	Assist/Control, Volume	Peep	5 cmH <sub>2</sub> O
Breath Rate	15 bpm	O <sub>2</sub> %	21%
Tidal Volume	800 ml	Lung Compliance	50 ml/cmH <sub>2</sub> O
Inspiratory Time	1.5 sec	ET Tube Resistance	5.87 cmH <sub>2</sub> O/L/s
Sensitivity	2 lpm	Battery Temperature	25° C

When an LTV<sup>®</sup> 1200 ventilator is operated on its internal battery to the point that the internal battery is completely depleted, the ventilator will shut down. If the ventilator remains in this state, the internal battery may recharge slightly within a few seconds / minutes and cause the ventilator to automatically restart and operate for a short period of time. This cycle may repeat several times, depending on the condition of the internal battery.

## *Battery Level (cont)*

### **WARNING**

**Battery run time** - When the battery reaches the **BAT LOW** level, the ventilator will only run for approximately 10 minutes before generating a battery empty alarm (**BAT EMPTY**). The approximate times shown here are based on tests using the **nominal settings, a new battery and a full 8- hour charge cycle** as specified in *Appendix A - Ventilator Specifications*. Actual run time may be more or less depending on ventilator settings, patient demand, and battery age or condition. It is highly recommended that an alternate power source is secured **PRIOR** to the ventilator reaching the **BAT EMPTY** alarm condition to ensure continuous, uninterrupted patient ventilation.

### **AVERTISSEMENT**

**Durée d'utilisation de la batterie** – Lorsque la batterie atteint le niveau **BAT INT BASS**, le ventilateur fonctionne pendant environ 10 minutes avant d'émettre une alarme de batterie faible (**BAT INT VIDE**). Cette durée approximative est basée sur des tests avec des paramètres nominaux, une nouvelle batterie et un cycle de chargement complet de 8 heures, tel que spécifié dans l'*Annexe A – Spécifications du ventilateur*. La durée d'utilisation réelle pourrait être supérieure ou inférieure, selon les paramètres du ventilateur, la demande du patient et l'âge ou l'état de la batterie. Il est fortement recommandé qu'une source d'alimentation alternative soit connectée **AVANT** que le ventilateur n'atteigne l'état d'alarme **BAT INT VIDE** afin d'assurer une ventilation continue et ininterrompue au patient.

## Charge Status

---

The **Charge Status** indicator shows the charge state of the internal battery. This LED is on when the ventilator is supplied with external power and the internal battery is being charged. The charge status is indicated as follows:

LED Color	Charge Status
Flashing Amber	The ventilator is performing pre-charge testing of the battery before starting the charge process. This occurs when external power is first connected. The process normally takes a few seconds but may take up to an hour on a deeply discharged battery.
Green	The internal battery is charged to full level. While in this state, the charger will continue to trickle charge the battery.
Amber	The internal battery is being bulk charged. The battery has not reached a full charge level yet.
Red	The ventilator has detected a charge internal battery fault. The internal battery cannot be charged.

### CAUTION

**Charge Fault** - If the **Charge Status** LED indicates a charge fault, contact a certified Pulmonetic Systems' service technician immediately.

**Internal Battery Use:** The internal battery is intended for use during short periods while switching between external power supplies, in emergencies or for short duration transports. The length of time the ventilator will operate on internal power is a function of factors such as settings, charge level and condition of the battery; therefore, the use of the internal battery as a standard operating practice is not recommended.

### ATTENTION

**Erreur de charge** - Si le DEL de l'état de charge indique une erreur de charge, veuillez contacter immédiatement un technicien de service certifié Pulmonetic Systems.

**Utilisation de la batterie interne:** La batterie interne est conçue pour être utilisée sur de courtes périodes pendant la commutation entre des connexions d'alimentation externe, les situations d'urgence ou les transports de courte durée. La durée pendant laquelle le ventilateur fonctionnera sur l'alimentation interne dépend de facteurs tels, la configuration, le niveau de la charge et la condition de la batterie; l'utilisation de la batterie interne pour l'opération normale n'est donc pas recommandée.

## External Power

---

The **External Power** indicator shows the level of external power while the ventilator is operating from an external power source. When the ventilator is running from the internal battery, the **External Power** indicator is off. When running from external power, the indicator shows the following levels: (See *Chapter 7 - Battery Level* for approximate battery time.)

LED Color	Power Level
Green	External Power level is acceptable
Amber	External Power level is low

External power may be provided by connecting the ventilator to an external DC power source, external battery or to the LTV<sup>®</sup> AC Power Adapter.

### CAUTION

**AC Power Source** - When connecting the ventilator to an AC power source, use only the approved LTV<sup>®</sup> AC Power Adapter.

**External DC Power Source or External Battery** - When connecting the LTV<sup>®</sup> 1200 ventilator to an external DC power source or external battery, use only the approved method and connectors specified in *Chapter 14 - Power and Battery Operation*.

**Internal Battery Use:** The internal battery is intended for use during short periods while switching between external power supply connections, emergency situations or short duration transports. The length of time the ventilator will operate on internal power is a function of many factors such as settings, charge level and condition or age of the battery; therefore, the use of the internal battery as a standard operating practice is not recommended.

### ATTENTION

**Source d'alimentation c.a.** - Lorsque vous branchez le ventilateur sur une source d'alimentation c.a., utilisez l'adaptateur c.a. LTV<sup>®</sup> approuvé.

**Source de courant continu ou pile externe** - Lorsque vous branchez les ventilateurs de la 1200 LTV<sup>®</sup> sur une source de courant continu ou sur une pile externe, utilisez seulement les méthodes et les connecteurs approuvés spécifiés au chapitre 14 - Alimentation et opération avec pile.

**Utilisation de la batterie interne:** La batterie interne est conçue pour être utilisée sur de courtes périodes pendant la commutation entre des connexions d'alimentation externe, les situations d'urgence ou les transports de courte durée. La durée pendant laquelle le ventilateur fonctionnera sur l'alimentation interne dépend de plusieurs facteurs tels, la configuration, le niveau de la charge et la condition ou l'âge de la batterie; l'utilisation de la batterie interne pour l'opération normale n'est donc pas recommandée.

## *NPPV*

---

The NPPV<sup>30</sup> indicator LED is lit when NPPV mode is selected. For more information on NPPV mode, see *NPPV Mode* in Chapter 4 - Ventilation Modes and *Procedure for NPPV Mode Set Up* in Chapter 12 – Operating Procedure.

## *Patient Effort*

---

This LED is lit briefly each time a patient trigger is detected. See *Chapter 6 - Controls, Sensitivity* for more information on patient triggers.

## *Vent Inop*

---

The **Vent Inop** LED is lit any time the ventilator is in the Inop state. This occurs when:

- The ventilator is put into Standby using the **On/Standby** button.
- The ventilator power sources, both external and internal, are insufficient to operate the ventilator.
- A **Vent Inop** alarm sounds.

An audible alarm sounds continuously when the ventilator enters the Vent Inop state, and may be silenced by pushing the **Silence Reset** button.

While in the Vent Inop state, the ventilator is set to a safe state, allowing the patient to breathe spontaneously from room air.

---

<sup>30</sup> Non-Invasive Positive Pressure Ventilation

## Chapter 8 - MONITORED DATA

This section describes each of the monitored data displays and how the data is calculated. Monitored data is shown in the Display Window and is actively updated whenever alarms and extended features are not displayed.

### NOTE

Some monitored data depends on valid transducer calibrations. If valid calibration data is not available, the monitored data display will be replaced with the message **NO CAL**.

### REMARQUE

Certaines données surveillées dépendent de la validité du calibrage du transducteur. Si des données de calibrage valides ne sont pas disponibles, les données surveillées affichées seront remplacées par le message **NO CAL**.



### WARNING

**NO CAL Condition** - Operation of the LTV<sup>®</sup> 1200 ventilator under a **NO CAL** condition may result in inaccurate pressure and volume measurements. Should this condition occur, disconnect the patient from the ventilator, provide an alternative method of ventilation and immediately contact a certified Pulmonetic Systems' service technician or Pulmonetic Systems, Inc.



### AVERTISSEMENT

**Condition NO CAL** - L'opération continue du ventilateur de la 1200 LTV<sup>®</sup> sous condition **NO CAL** peut résulter en mesures de pression et de volume erronées. Si cette condition se présente, le ventilateur doit être retiré du service, et vous devez immédiatement contacter votre technicien de service certifié de Pulmonetic Systems ou Pulmonetic Systems Inc.



## Automatic or Manual Data Display Scrolling

The monitored data displays may be automatically or manually scrolled.

**To cycle through the available monitored data automatically from a halted scan:**

- 1) Push the monitor **Select** button twice within 0.3 seconds.
- 2) Pushing the **Select** button once while scan is active will halt scanning and the currently displayed data will remain in the display window.
- 3) Each time you push the button once, the next data item in the list will be displayed.
- 4) To resume scan, push the **Select** button twice.

The monitored data is displayed for 3 seconds, in the following order:

Display	Monitored Data	Units
PIP	Peak Inspiratory Pressure	cmH <sub>2</sub> O
MAP	Mean Airway Pressure	cmH <sub>2</sub> O
PEEP	Positive End Expiratory Pressure	cmH <sub>2</sub> O
f	Total Breath Rate	Breaths Per Minute
Vte	Exhaled Tidal Volume	Milliliters
VE	Minute Volume	Liters
I:E	I:E Ratio	Smaller unit normalized to 1
I:Ecalc	Calculated I:E ratio based on Breath Rate and Inspiratory Time	Smaller unit normalized to 1
Vcalc	Calculated Peak Flow for Volume Breaths	Liters Per Minute
SBT min <sup>31</sup>	Remaining time for SBT mode of ventilation	Minutes
f/Vt f <sup>32</sup>	Total Breath Rate divided by the Average Exhaled Tidal Volume, and the Total Breath	f/Vt and Breaths Per Minute

Following the displayed monitored data, the Alarm Informational Messages listed below (when applicable) will be displayed for 3 seconds.

### NOTE

While automatic scrolling is active and when applicable, the following messages<sup>33</sup> will also be displayed along with the monitored data:

\* LMV OFF      \* HI f/Vt OFF      \* SBT HI f OFF      \* HIGH f OFF<sup>34</sup>      \* LO PEEP OFF  
 \* LPPS OFF      \* LO f/Vt OFF      \* SBT LO f OFF      \* HI PEEP OFF      \* H&L PEEP OFF  
 \* LMV LPPS OFF      \* SBT f/Vt OFF      \* SBT f OFF      \* f PEEP OFF<sup>34</sup>

### REMARQUE

Lorsque le défilement automatique est actif, et en fonction du contexte, les messages suivants seront également affichés avec les données surveillées :

\* Vmin ARRET      \* f/Vt max NON      \* VST fmax NON      \* f HTE ARRET      \* PEP MIN OFF  
 \* PminAI ARRET      \* f/Vt min NON      \* VST fmin NON      \* PEPmax ARRET      \* AL PEP ARRET  
 \* Vm-Pmin NON      \* VST f/Vt NON      \* VST f NON      \* f PEP ARRET

<sup>31</sup> **SBT min** is only displayed during the Spontaneous Breathing Trial (SBT) mode of ventilation.

<sup>32</sup> **f/Vt f** is only displayed during, and for five minutes after, the Spontaneous Breathing Trial (SBT) mode of ventilation has ended.

<sup>33</sup> See *Chapter 9 - Ventilator Alarms*, for additional information.

<sup>34</sup> **HIGH f OFF** and **f PEEP OFF** messages are not displayed during SBT ventilation.

### *PIP xxx cmH2O*

---

The Peak Inspiratory Pressure (PIP) monitor displays the greatest pressure measured during the inspiratory phase and the first 300 ms of exhalation<sup>35</sup>.

Monitored PIP data is measured and displayed at the completion of inspiration.

### *MAP xx cmH2O*

---

The Mean Airway Pressure (MAP) monitor displays a running average of the airway pressure for the last 60 seconds. MAP data is recalculated and displayed in 10 second intervals.

### *PEEP xx cmH2O*

---

The Positive End Expiratory Pressure (PEEP) monitor displays the pressure in the patient circuit at the completion of exhalation. PEEP data is displayed at the completion of exhalation.

### *f xxx bpm*

---

The Total Breath Rate displays the breaths per minute based on the last 8 breaths, and includes all breath types. Total Breath Rate is recalculated and updated at the end of each exhalation or every 20 seconds.

### *Vte xxx ml*

---

The Exhaled Tidal Volume (Vte) monitor displays the tidal volume as measured at the patient wye. Vte data is recalculated and displayed at the completion of every exhalation.

### *VE xx.x L*

---

The Minute Volume (VE) monitor displays the exhaled tidal volume for the last 60 seconds as calculated from the last 8 breaths. VE data is recalculated and displayed at the completion of every exhalation or every 20 seconds, whichever occurs first.

### *I:E xx:xx*

---

The I:E Ratio displays the unitless ratio between measured inspiratory time and measured exhalation time. The smaller of the inspiratory and exhalation times is normalized to one. Both normal and inverse I:E Ratios are displayed.

---

<sup>35</sup> This is done to protect the patient, since often the highest pressure is obtained at the beginning of the exhalation phase.

### *I:Ecalc xx:xx*

---

The **Calculated I:E ratio (I:Ecalc)** display is based on the set Breath Rate and Inspiratory Time. The display is updated in real-time while either setting is being changed. In modes where Vcalc is displayed during Inspiratory Time changes, the display can be toggled between **Vcalc** and **I:E calc** using the **Select** button.

### *Vcalc xxx Lpm*

---

The Calculated Peak Flow is based on the Tidal Volume and Inspiratory Time settings. Vcalc is included in the list of monitored values when **Volume** ventilation is selected, and is not included when **Pressure** ventilation is selected. **Vcalc** is automatically displayed when Tidal Volume or Inspiratory Time<sup>36</sup> is selected for change. When both controls are deselected, the previously displayed monitored data will be restored to the display window.

### *SBT xxx min*

---

During the Spontaneous Breathing Trial (SBT) mode of ventilation, the monitor displays the time remaining until the number of minutes preset in the SBT OP, MINUTES menu have elapsed. When this preset time has elapsed, the SBT mode of ventilation is terminated, an **SBT OFF** alarm is generated and the ventilator returns to the previously set modes/settings.

### *xxx f/Vt xx f*

---

During a Spontaneous Breathing Trial (SBT), when DISPLAY ON has been selected in the SBT DISPLAY f/Vt menu, the monitor displays the current values of the Total Breath Rate divided by the Average Exhaled Tidal Volume (f/Vt), and the Total Breath Rate (f).

- f/Vt is computed every time the Total Breath Rate (f) or Total Minute Volume (VE) is calculated. At the completion of the SBT mode of ventilation, the final values of the Total Breath Rate divided by the Average Exhaled Tidal Volume (f/Vt), and Total Breath Rate (f) are displayed and retained for an additional five minutes.

---

<sup>36</sup> Vcalc is only displayed while Inspiratory Time is selected if Volume Mode is selected. Vcalc is displayed any time Tidal Volume is selected regardless of the current ventilation mode.

## Chapter 9 - VENTILATOR ALARMS

When conditions requiring immediate operator interaction are detected by the LTV<sup>®</sup> 1200 ventilator, an alarm is generated. Some alarms can reset themselves, for instance, a high pressure alarm that is caused by a cough. Other alarms require some action from the operator and the audible and visual alarms will continue until the problem is corrected.

### When an alarm occurs:

- A flashing alarm message appears in the display window.
- An audible alarm sounds.
- Any associated control displays flash.
- Depending on the alarm, other actions may be taken, such as terminating an inspiration or opening the exhalation valve.

### When an alarm condition clears:

- The audible alarm is silenced.
- The alarm message continues to flash in the display window.
- Any associated control displays continue to flash.

### **WARNING**

**Adjustable and Critical Alarms** – For safety purposes, all adjustable alarms and all critical alarms must be checked to insure proper operation.

**Audible Alarms** - Failure to immediately identify and correct audible alarm situations may result in serious patient injury.

### **AVERTISSEMENT**

**Alarmes réglables et critiques** – Pour assurer la sécurité et obtenir un fonctionnement adéquat, toutes les alarmes réglables et critiques doivent être vérifiées.

**Alarmes sonores** - L'échec à identifier et à corriger dans l'immédiat les situations d'alarmes sonores peut causer des blessures au patient.

The following sections describe what alarms can occur on the LTV<sup>®</sup> 1200 ventilator and how to correct them.

## Alarms

---

### APNEA, APNEA xx bpm

---

When the time since the start of the last breath is longer than the set Apnea Interval, the **APNEA** alarm is generated. When an Apnea alarm occurs, the ventilator will enter Apnea Backup ventilation mode. For more information on Apnea Backup mode, see *Chapter 4 - Ventilation Modes, Apnea Backup*. For more information on the variable Apnea Interval, see *Chapter 10 - Extended Features*.

#### When an APNEA alarm occurs:

- Any inspiration in progress is terminated.
- The ventilator changes to Apnea Backup ventilation.
- The **APNEA xx bpm** backup ventilation breath rate is displayed.
- Control displays used while in Apnea Backup mode are illuminated and all other control displays are dimmed.
- The audible alarm is sounded.

While in Apnea Backup mode, the alarm will continue to sound and the alarm message and breath rate will be flashed in the display window. Apnea backup mode will continue until the operator resets the alarm or the patient triggers 2 consecutive breaths.

#### When the APNEA alarm is reset by 2 consecutive triggered breaths:

- Apnea Backup Ventilation terminates and the ventilator returns to the previous mode.
- The **APNEA** alarm message remains flashing in the window but the breath rate is no longer displayed.
- Control displays used in the selected ventilation mode are illuminated and all other control displays are dimmed.
- The audible alarm is silenced.

#### To reset the APNEA alarm and exit Apnea Backup ventilation:

- 1) Push the **Silence Reset** button twice.

## BAT EMPTY

---

When the ventilator is operating on internal battery power and the battery charge level falls below the empty threshold, the **BAT EMPTY** alarm is generated. For patient safety, this alarm can only be silenced once for 30 seconds and cannot be silenced preemptively. After the 30 seconds has elapsed, the alarm cannot be silenced again and will continue to sound and display until an alternate power source is provided or the battery is depleted and the ventilator goes INOP. This alarm will always sound at maximum volume (85 dbA)

### **WARNING**

**BAT EMPTY alarm** - A **BAT EMPTY** alarm indicates the internal battery is almost depleted. Connect the ventilator to an external power source immediately.

### **AVERTISSEMENT**

**Alarme BAT EMPTY** - Une alarme **BAT EMPTY** indique que la pile interne est pratiquement à plat. Branchez immédiatement le ventilateur à une source d'alimentation externe.

#### **When a BAT EMPTY alarm occurs:**

- The **Battery Level** LED displays red.
- The **BAT EMPTY** message is displayed.
- The audible alarm is sounded.

### **NOTE**

Volume of the **BAT EMPTY** alarm cannot be lowered. For patient safety, this alarm will always sound at full volume.

### **REMARQUE**

Le volume de l'alarme batterie faible ne peut être réduit. Pour la sécurité des patients, le volume de l'émission de cette alarme est toujours fort.

#### **To temporarily silence the BAT EMPTY alarm:**

- 1) Push the **Silence Reset** button once to silence the audible alarm for 30 seconds only.

The **BAT EMPTY** alarm can only be silenced once and cannot be reset until the battery is recharged or external power is applied.

## BAT EMPTY (cont.)

### **NOTE**

When the battery reaches empty, the ventilator may run for approximately 5 minutes before shutdown, based on the nominal settings, a new battery and a full 8 - hour charge cycle as specified in *Appendix A - Ventilator Specifications*. Actual run time may be more or less depending on ventilator settings, patient demand, and battery age.

**Internal Battery Use:** The internal battery is intended for use during short periods while switching between external power supply connections, emergency situations or short duration transports. The length of time the ventilator will operate on internal power is a function of many factors such as settings, charge level and condition or age of the battery; therefore, the use of the internal battery as a standard operating practice is not recommended.

### **REMARQUE**

Lorsque la batterie atteint le niveau Vide, le ventilateur continuera de fonctionner pendant environ cinq minutes avant de s'éteindre, dans le cas de réglages nominaux, d'une nouvelle batterie et d'un cycle de charge complet de huit heures, tel que spécifié dans *l'annexe A, Ventilator Specifications*. La durée de fonctionnement réelle peut être inférieure ou supérieure, suivant les réglages du ventilateur, les besoins du patient et l'âge de la batterie.

**Utilisation de la batterie interne:** La batterie interne est conçue pour être utilisée sur de courtes périodes pendant la commutation entre des connexions d'alimentation externe, les situations d'urgence ou les transports de courte durée. La durée pendant laquelle le ventilateur fonctionnera sur l'alimentation interne dépend de plusieurs facteurs tels, la configuration, le niveau de la charge et la condition ou l'âge de la batterie; l'utilisation de la batterie interne pour l'opération normale n'est donc pas recommandée.

When an LTV<sup>®</sup> 1200 ventilator is operated on its internal battery to the point that the internal battery is completely depleted, the ventilator will shut down. If the ventilator remains in this state, the internal battery may recharge slightly within a few seconds / minutes and cause the ventilator to automatically restart and operate for a short period of time. This cycle may repeat several times, depending on the condition of the internal battery.

## BAT LOW

---

When the ventilator is operating on internal battery power and the battery charge level falls below the low threshold, a **BAT LOW** alarm is generated.

### When a **BAT LOW** alarm occurs:

- The **Battery Level** LED is displayed Amber.
- The **BAT LOW** message is displayed.
- The audible alarm is sounded.

### To reset the **BAT LOW** alarm:

- 1) Push the **Silence Reset** button twice.

## **WARNING**

**Battery run time:** When the battery reaches the **BAT LOW** level, the ventilator will only run for approximately 10 minutes before generating a battery empty alarm (**BAT EMPTY**). This approximate time is based on tests using the **nominal settings, a new battery and a full 8 hour charge cycle** as specified in *Appendix A - Ventilator Specifications*. Actual run time may be more or less depending on ventilator settings, patient demand, and battery age or condition. It is highly recommended that an alternate power source is connected **PRIOR** to the ventilator reaching the **BAT EMPTY** alarm condition to ensure continuous, uninterrupted patient ventilation

## **AVERTISSEMENT**

**Durée d'utilisation de la batterie** – Lorsque la batterie atteint le niveau **BAT INT BASS**, le ventilateur fonctionne pendant environ 10 minutes avant d'émettre une alarme de batterie faible (**BAT INT VIDE**). Cette durée approximative est basée sur des tests avec des paramètres nominaux, une nouvelle batterie et un cycle de chargement complet de 8 heures, tel que spécifié dans l'*Annexe A – Spécifications du ventilateur*. La durée d'utilisation réelle pourrait être supérieure ou inférieure, selon les paramètres du ventilateur, la demande du patient et l'âge ou l'état de la batterie. Il est fortement recommandé qu'une source d'alimentation alternative soit connectée **AVANT** que le ventilateur n'atteigne l'état d'alarme **BAT INT VIDE** afin d'assurer une ventilation continue et ininterrompue au patient



## BAT LOW (cont)

### **NOTE**

**Internal Battery Use:** The internal battery is intended for use during short periods while switching between external power supply connections, emergency situations or short duration transports. The length of time the ventilator will operate on internal power is a function of factors such as settings, charge level and condition or age of the battery; therefore, the use of the internal battery as a standard operating practice is not recommended.

### **REMARQUE**

**Utilisation de la batterie interne:** La batterie interne est conçue pour être utilisée sur de courtes périodes pendant la commutation entre des connexions d'alimentation externe, les situations d'urgence ou les transports de courte durée. La durée pendant laquelle le ventilateur fonctionnera sur l'alimentation interne dépend de plusieurs facteurs tels, la configuration, le niveau de la charge et la condition ou l'âge de la batterie; l'utilisation de la batterie interne pour l'opération normale n'est donc pas recommandée.

When an LTV<sup>®</sup> 1200 ventilator is operated on its internal battery to the point that the internal battery is completely depleted, the ventilator will shut down. If the ventilator remains in this state, the internal battery may recharge slightly within a few seconds / minutes and cause the ventilator to automatically restart and operate for a short period of time. This cycle may repeat several times, depending on the condition of the internal battery.

## DEFAULTS

---

All controls and extended features on the LTV<sup>®</sup> 1200 ventilator have factory-set default values. When the operator makes changes to the controls or extended features settings, the ventilator stores the new settings in non-volatile memory<sup>37</sup>. During POST, the ventilator checks the stored settings. If the ventilator detects an invalid stored setting, the **DEFAULTS** alarm occurs and the affected settings are set to the default values.

### When a **DEFAULTS** alarm is generated:

- An audible alarm is sounded.
- The **DEFAULTS** message is flashed in the display window.
- All affected controls or features are set to their default values.

### To reset the **DEFAULTS** alarm:

- 1) Push the **Silence Reset** button twice.
- 2) Select and return the control(s) or features to the desired settings.

## NOTE

Be sure to check all Controls, Alarms and Extended Features options and return them to the desired settings.

Repeated occurrences of the **DEFAULTS** alarm may indicate a problem with the ventilator's non-volatile memory. Please immediately contact a certified Pulmonetic Systems' service technician.

Control values are re-set to default values each time the ventilator is turned on, **only** if an invalid stored setting is detected during POST.

## REMARQUE

Assurez-vous de procéder à la vérification de toutes les options de contrôles, d'alarmes et de caractéristiques étendues, et de les retourner aux réglages souhaités.

L'occurrence répétitive des alarmes **PAR DÉFAUT** peut indiquer un problème avec la mémoire non volatile du ventilateur. Veuillez contacter immédiatement un technicien de service certifié de Pulmonetic Systems.

Les valeurs de contrôle sont rétablies à leurs valeurs par défaut chaque fois que le ventilateur est allumé, **seulement** si un paramètre en mémoire non valable est détecté au moment du diagnostic automatique de mise sous tension.

---

<sup>37</sup> Non-volatile memory is memory that is not erased when the ventilator is turned off or disconnected.

## DEFAULTS (cont.)

### The factory-set default Control settings are:

- See *Chapter 6 - Controls*, for detailed information concerning specific Controls.

<u>Control</u> - <u>Default</u>	<u>Control</u> - <u>Default</u>
Breath Rate - 12 bpm	O <sub>2</sub> % (O <sub>2</sub> Flush) - 21%
Control Lock - On	PEEP - 0 cmH <sub>2</sub> O
Data Display Scrolling - Auto-On	Pressure Control - 1 cmH <sub>2</sub> O
High Pressure Limit - 20 cmH <sub>2</sub> O	Pressure Support - 1 cmH <sub>2</sub> O
Inspiratory/Expiratory Hold - Off	Sensitivity - 2 Lpm
Inspiratory Time - 1.5 sec	Tidal Volume - 500 ml
Low Minute Volume - 2.5 Lpm	Ventilation Mode - Assist/Control
Low Pressure - 5 cmH <sub>2</sub> O	Volume Pressure Mode - Volume
Low Pressure O <sub>2</sub> Source - Off	

### The factory-set default Extended Features settings are:

- See *Chapter 10 - Extended Features*, for detailed information concerning specific Features.

<u>Feature</u> - <u>Default</u>	<u>Feature</u> - <u>Default</u>
Alarm Volume - 85 dBA	Patient Query - On
Apnea Interval - 20 sec	Patient Size - INFANT
Com Setting <sup>38</sup> - Data	PC Flow Termination - Off
Control Unlock - Easy	PIP LED - On
Date Format - MM/DD/YYYY	Rise Time Profile - 4
High f Alarm - High f Off	SBT Display f/Vt Alarm - Off
High f Alarm Delay - 30 sec	SBT FIO <sub>2</sub> - 21%
High PEEP Alarm - PEEP +5 cmH <sub>2</sub> O	SBT High f Alarm - 35 bpm
HP Alarm Delay - No Delay	SBT High f/Vt Alarm - 105 f/Vt
Language - English	SBT Low f Alarm - 10 bpm
Leak Compensation - On	SBT Low f/Vt Alarm - 70 f/Vt
Low PEEP Alarm - PEEP -5 cmH <sub>2</sub> O	SBT Mode - Off
LPP Alarm - All Breaths	SBT Mode Run Time - 20 min
NPPV Mode - Off	SBT PEEP - 0 cmH <sub>2</sub> O
O <sub>2</sub> Duration Cylinder - 2000 psi or 138 bar	SBT Pressure Support - 10 cmH <sub>2</sub> O
O <sub>2</sub> Duration Cylinder - 622 liters	Variable Flow Termination - 25%
O <sub>2</sub> Flush Period - 3 min	Variable Time Termination - 1.5 sec
Patient Assist - Normal	

---

<sup>38</sup> This feature is not reset to default values when the **SET DEFAULTS** option is used in Extended Features.

## DEFAULTS SET

---

The **DEFAULTS SET** alarm is generated when the LTV<sup>®</sup> 1200 ventilator is first powered up after the **SET DEFAULTS**<sup>39</sup> option has been used to reset all controls and extended features settings to their factory-set default values<sup>40</sup>.

- Language, Time/Date Format and Com settings are not reset to default values when the SET DEFAULTS option is used in Extended Features.

### When a DEFAULTS SET alarm is generated:

- The **DEFAULTS SET** message is flashed in the display window.
- The audible alarm is sounded.

### To reset the DEFAULTS SET alarm:

- 1) Push the **Silence Reset** button twice.
- 2) Select and return the control(s) and extended features settings to the desired settings.

## NOTE

Be sure to check all Controls, Alarms and Extended Features options and return them to the desired settings.

## REMARQUE

Assurez-vous de procéder à la vérification de toutes les options de contrôles, d'alarmes et de caractéristiques étendues, et de les retourner aux réglages souhaités.

---

<sup>39</sup> See *Chapter 10 - Extended Features, Set Defaults* for additional information.

<sup>40</sup> See *Chapter 9 - Ventilator Alarms, DEFAULTS* for factory-set default values.

## *DISC/SENSE*

---

When the ventilator detects one of the following conditions, the **DISC/SENSE** alarm is generated:

- When a sense line is pinched or blocked.
- When a sense line has become disconnected.
- When a sense line is occluded (e.g., excessive condensation in the line).

The ventilator detects circuit pressure during the beginning of each inspiration. If an appropriate pressure change is not detected, a **DISC/SENSE** alarm occurs. While the **DISC/SENSE** alarm is active, the ventilator cannot sense the circuit pressure so the breath is terminated.

### **When a DISC/SENSE alarm occurs:**

- Inspiration is immediately terminated and exhalation begins.
- The **DISC/SENSE** message is flashed in the display window.
- The audible alarm is sounded.

### **To reset the DISC/SENSE alarm:**

- 1) Push the **Silence Reset** button to silence the alarm.
- 2) Push the **Silence Reset** button to reset the alarm.

## *HIGH f*

---

When the Total Breath Rate (f) exceeds the high breath rate and time period alarm values, the **HIGH f** alarm is generated.

- To prevent nuisance alarms, the **HIGH f** alarm is suspended for the first 60 seconds of ventilator operation after power up and passing the Power On Self Tests.

### **When a HIGH f alarm occurs:**

- The **HIGH f** message is flashed in the display window.
- The audible alarm is sounded.

### **To reset the HIGH f alarm:**

- 1) Push the **Silence Reset** button once to silence the audible alarm.
- 2) Push the **Silence Reset** button twice to reset the alarm (silences the audible alarm and clears the flashing display).
  - When the **HIGH f** alarm is reset (**Silence Reset** button pushed twice), the alarm is suspended for the next 60 seconds.
  - The 60-second suspension of the **HIGH f** alarm is only enabled when the alarm is manually silenced/reset by pushing the **Silence Reset** button twice. It is not enabled when the **HIGH f** alarm is automatically silenced/reset because the patient's breath rate no longer exceeds the set **HIGH f** alarm value.

## *HIGH O<sub>2</sub> PRES*

---

When the average oxygen inlet pressure exceeds the acceptable limit for the type of oxygen source, the **HIGH O<sub>2</sub> PRES** alarm is generated.

- If Low Pressure O<sub>2</sub> Source is selected, the inlet pressure is >10 PSIG.
- If Low Pressure O<sub>2</sub> Source is not selected and the oxygen concentration is set to greater than 21%, the inlet pressure is >85 PSIG.

When the Low Pressure O<sub>2</sub> Source option is selected and a high O<sub>2</sub> pressure source is attached to the ventilator, an Automatic High O<sub>2</sub> Switch Over safety response generates a **HIGH O<sub>2</sub> PRES** alarm, switches the ventilator to High Pressure O<sub>2</sub> Source mode and sets the percentage of oxygen to be delivered in the gas flow to 21%.

### **When a HIGH O<sub>2</sub> PRES alarm occurs:**

- The **HIGH O<sub>2</sub> PRES** message is flashed in the display window.
- The **O<sub>2</sub> % (O<sub>2</sub> Flush)** control display is flashed.
- The audible alarm is sounded.

### **To reset the HIGH O<sub>2</sub> PRES alarm:**

- 1) Push the **Silence Reset** button to silence the alarm.
- 2) Adjust the oxygen inlet pressure.
- 3) Push the **Silence Reset** button to reset the alarm.

## *HIGH PEEP*

---

When the patient circuit positive end expiratory pressure (PEEP) exceeds the High PEEP alarm setting, the **HIGH PEEP** alarm is generated.

**When a HIGH PEEP alarm occurs:**

- The **HIGH PEEP** message is flashed in the display window.
- The audible alarm is sounded.

**To reset the HIGH PEEP alarm:**

- 1) Push the **Silence Reset** button once to silence the audible alarm.
- 2) Push the **Silence Reset** button twice to reset the alarm (silences the audible alarm and clears the flashing display).



## HIGH PRES

---

When the pressure in the patient circuit is greater than the High Pressure Limit setting, the **HIGH PRES** alarm is generated. When this alarm occurs, any inspiration in progress is terminated and the exhalation valve is opened. The turbine is stopped to allow the circuit pressure to evacuate when the high pressure condition persists for more than four times the set inspiratory time or more than 3.0 seconds, whichever is less.

### **WARNING**

**Sustained HIGH PRES Alarm** - During a sustained High Pressure alarm condition (**HIGH PRES**), the ventilator's turbine is stopped and gas is not delivered to the patient. Disconnect the patient from the ventilator and ventilate the patient using an alternative method. See *Chapter 15 - Troubleshooting, Alarms* for additional information concerning the **HIGH PRES** alarm.

### **AVERTISSEMENT**

**Alarme ALARME PMAX continue** — Dans des conditions d'alarme de haute pression prolongées (**ALARME PMAX**), la turbine du ventilateur s'arrête et le gaz n'est plus transmis au patient. Débranchez le patient du ventilateur et utilisez une autre méthode de ventilation. Pour plus de détails sur l'état **ALARME PMAX**, reportez-vous au *chapitre 15, Troubleshooting, Alarms*.

Immediate or delayed audible alarms for high pressure conditions can be selected using the Extended Features<sup>41</sup>. If immediate notification is selected, the audible alarm will sound on every high pressure occurrence. If Delayed notification is selected, the audible alarm will sound on the second or third consecutive breath terminated by the **HIGH PRES** alarm. The audible alarm will sound anytime a high pressure condition persists which stops the turbine.

### **NOTE**

The High Pressure alarm output signal is generated by the ventilator's Patient Assist Port for use with Remote Alarm systems. This signal is dependent on the selected setting (**NORMAL** or **PULSE**) in the Extended Features, **PNT ASSIST** menu. See *Chapter 10 - Extended Features, Alarm Operations*, for instructions on setting the Patient Assist Port output signal for use with single or dual tone Remote Alarm systems.

### **REMARQUE**

Le signal de sortie correspondant à l'alarme de pression élevée est généré sur le port d'assistance au patient pour une utilisation avec des systèmes d'alarme à distance. Ce signal dépend du réglage choisi (**NORMAL** ou **IMPULSION**) dans le menu Fonctions avancées, **PNT ASSIST**. Reportez-vous au *chapitre 10, Extended Features, Alarm Operations* pour plus de détails sur le réglage du signal de sortie sur le port d'assistance au patient et sur son utilisation avec des systèmes d'alarme à distance à fréquence simple ou double.

---

<sup>41</sup> For more information on selecting the High Pressure Alarm Delay, see *Chapter 10 - Extended Features*.

### High PRES (cont.)

The **HIGH PRES** alarm becomes inactive and is automatically silenced using the following criteria:

<b>High Pressure Limit Setting</b>	<b>Circuit Pressure at which HIGH PRES alarm is silenced</b>
31 to 100 cmH <sub>2</sub> O	Less than 25 cmH <sub>2</sub> O
8 to 30 cmH <sub>2</sub> O	More than 5 cmH <sub>2</sub> O lower than current High Pressure Limit Setting
5 to 7 cmH <sub>2</sub> O	Less than 2 cmH <sub>2</sub> O

#### **When a HIGH PRES alarm occurs:**

- Inspiration is immediately terminated and exhalation begins.
- The **HIGH PRES** message is flashed in the display window.
- The High Pressure Limit control display is flashed.
- The audible alarm is sounded.

#### **To reset the HIGH PRES alarm:**

- 1) Push the **Silence Reset** button to silence the alarm.
- 2) Resolve the high pressure problem.
- 3) Push the **Silence Reset** button to reset the alarm.

## HW FAULT

---

When the ventilator detects one of the following hardware faults, the **HW FAULT** alarm is generated:

- The cooling fan is not operating, or the fan filter may be blocking the fan (see page 13-2 for cleaning and installation instructions).
- A problem is detected with the analog to digital converters.
- A problem is detected with the flow valve.
- A problem is detected with the processor.
- A problem is detected with the EEPROM memory.
- A problem is detected writing data to the EEPROM during system shutdown.
- A problem is detected with the audible alarm circuitry.
- A problem is detected with the alarm sounder.

The **HW FAULT** alarm may occur as a result of ESD<sup>42</sup> or other transient causes. If the problem is temporary, the alarm will automatically silence when the condition clears. If the problem persists, or you experience repeated **HW FAULT** alarms, immediately contact a certified Pulmonetic Systems' service technician or Pulmonetic Systems.

- To determine the type of hardware fault detected by the ventilator, see *Appendix E - Event Trace*.

### When a HW FAULT alarm occurs:

- The **HW FAULT** message is flashed in the display window.
- The audible alarm is sounded.

### To reset the HW FAULT alarm:

- 1) Push the **Silence Reset** button twice.
- 2) If the alarm occurs again, immediately contact a certified Pulmonetic Systems' service technician or Pulmonetic Systems.

## NOTE

Repeated or continuous **HW FAULT** alarms may indicate a hardware failure that could prevent the ventilator from performing within its specifications. Remove the ventilator from service and immediately contact a certified Pulmonetic Systems' service technician or Pulmonetic Systems.

## REMARQUE

Des erreurs **HW FAULT** répétitives ou continues peuvent indiquer une panne matérielle qui pourrait empêcher le ventilateur de fonctionner à l'intérieur des limites spécifiées. Retirer le ventilateur du service, et contactez immédiatement un technicien de service certifié de Pulmonetic Systems ou Pulmonetic Systems.

---

<sup>42</sup> Electrostatic Discharge.

An **INOP** alarm is generated when:

- The ventilator is switched from **On** to **Standby**.
- The ventilator detects any condition that is deemed to make the ventilator unsafe.

When an **INOP** occurs, the ventilator shuts down and sets the hardware to a safe state so the patient can breathe from room air.

**When an INOP alarm occurs:**

- Inspiratory flow is stopped and the exhalation valve is opened, allowing the patient to breathe spontaneously from room air.
- The oxygen blending solenoids are closed.
- The **INOP** LED is illuminated red.
- The audible alarm is sounded continuously.

**To silence the INOP alarm:**

- 1) Push the **Silence Reset** button to silence the alarm. Verify a confirming audible chirp occurs after the alarm is silenced<sup>43</sup>.



### WARNING

**Alternative Ventilation** - It is recommended that an alternative means of ventilating the patient be available at all times and that all ventilator operators be fully familiar with emergency ventilation procedures.

**INOP Alarm** - If an **INOP** alarm occurs during operation, ventilate the patient using an alternative method, disconnect the ventilator, and immediately contact a certified Pulmonetic Systems' service technician or Pulmonetic Systems, Inc.



### AVERTISSEMENT

**Ventilation alternative** - Il est recommandé qu'un moyen alternatif de ventilation soit disponible en tout temps, et que tous les opérateurs de ventilateur soient pleinement familiers avec les procédures de ventilation d'urgence.

**Alarme INOP** - Si une alarme **INOP** survient au cours de l'opération, ventilez le patient à l'aide de la méthode alternative, retirez immédiatement le ventilateur du service, et contactez immédiatement votre technicien de service certifié de Pulmonetic Systems ou Pulmonetic Systems Inc.

### NOTE

An **INOP** alarm is generated as a part of the normal process of switching the ventilator from On to the Standby state and does not indicate a problem with the ventilator. The **INOP** LED will remain lit for a minimum of 5 minutes and does not affect battery life.

### REMARQUE

Une alarme **INOP** est générée au cours du processus normal de commutation du ventilateur de la position On (Marche) à la position Standby State (État d'attente), et n'indique pas un problème de fonctionnement du ventilateur. La DEL **INOP** restera allumée durant au moins 5 minutes et n'affecte en rien la durée de vie de la batterie.

---

<sup>43</sup> The audible chirp occurs after the Inop Alarm sounds for longer than 0.8 seconds and is then silenced.

## LOW MIN VOL

---

When the exhaled minute volume (VE) is less than the Low Minute Volume setting, the **LOW MIN VOL** alarm is generated.

- To prevent nuisance alarms, the **LOW MIN VOL** alarm is suspended for the first 20 seconds of ventilator operation after power up and passing the Power On Self Tests.

### When a LOW MIN VOL alarm occurs:

- The **LOW MIN VOL** message is flashed in the display window.
- The **Low Min. Vol.** control display is flashed.
- The audible alarm is sounded.

### To reset the LOW MIN VOL alarm:

- 1) Push the **Silence Reset** button twice.

## **WARNING**

**Low Minute Volume Control Settings** - The **Low Min. Vol.** control should be set to its highest clinically appropriate value. If there is a clinical need to set the Low Minute Volume alarm to lower values or off (" - - "), perform a clinical assessment to determine if an alternative monitor (i.e. a Pulse Oxymeter with an audible alarm, or a Cardio Respiratory Monitor) should be used.

## **AVERTISSEMENT**

**Réglages du contrôle de volume bas par minute** - Le contrôle du volume bas par minute doit être ajusté à la plus haute valeur clinique appropriée. Si l'alarme de volume bas par minute doit être ajustée à des valeurs inférieures ou mise à l'arrêt (" - - ") pour satisfaire aux besoins cliniques, effectuer une évaluation clinique afin de déterminer si l'utilisation d'un autre moniteur (c.-à-d., sphygmo-oxymètre muni d'une alarme sonore ou un moniteur cardio-respiratoire) s'avère pertinente.

## LOW O<sub>2</sub> PRES

---

When the average oxygen inlet pressure is less than the minimum inlet pressure of 35 PSIG, the **LOW O<sub>2</sub> PRES** alarm is generated. This alarm is only active when Low Pressure O<sub>2</sub> Source is not selected and the oxygen concentration is set to greater than 21%.

### **NOTE**

The LTV<sup>®</sup> 1200 features an enhanced Low O<sub>2</sub> Pressure alarm algorithm which allows for a brief, temporary drop of the O<sub>2</sub> pressure supply while maintaining delivered O<sub>2</sub> %.

### **REMARQUE**

Le LTV est caractérisé par un algorithme amélioré ↔alarme de pression d'oxygène basse, lequel permet la chute brève et temporaire de l'approvisionnement de pression d'oxygène basse tout en maintenant le % d'oxygène administré.

#### **When a LOW O<sub>2</sub> PRES alarm occurs:**

- The **LOW O<sub>2</sub> PRES** message is flashed in the display window.
- The **O<sub>2</sub>% (O<sub>2</sub> Flush)** control display is flashed.
- The audible alarm is sounded.

#### **To reset the LOW O<sub>2</sub> PRES alarm:**

- 1) Push the **Silence Reset** button to silence the alarm.
- 2) Reset the ventilator's oxygen inlet pressure.
- 3) Push the **Silence Reset** button to reset the alarm.

## *LOW PEEP*

---

When the patient circuit positive end expiratory pressure (PEEP) is less than the Low PEEP alarm setting, the **LOW PEEP** alarm is generated.

### **When a LOW PEEP alarm occurs:**

- The **LOW PEEP** message is flashed in the display window.
- The audible alarm is sounded.

### **To reset the LOW PEEP alarm:**

- 1) Push the **Silence Reset** button once to silence the audible alarm.
- 2) Push the **Silence Reset** button twice to reset the alarm (silences the audible alarm and clears the flashing display).

## LOW PRES

---

When the peak inspiratory pressure for a selected breath is less than the **Low Pressure** setting, the **LOW PRES** alarm is generated. The Low Pressure alarm can be set to apply to all breaths (**ALL BREATHS**) or to Volume Control (**VC**) and Pressure Control (**PC**) breaths only. (For information on selecting breath types, see *Chapter 10 - Extended Features, Low Peak Pressure Alarm.*)

### When a LOW PRES alarm occurs:

- The **LOW PRES** message is flashed in the display window.
- The **Low Pressure** control display is flashed.
- The audible alarm is sounded.

### To reset the LOW PRES alarm:

- 1) Push the **Silence Reset** button twice.

## **WARNING**

**Patient Circuit Accessories** - The use of accessories such as Speaking Valves, Heat-Moisture Exchangers and Filters create additional patient circuit resistance and in the event of a disconnection, may impede the generation of a Low Pressure alarm. Ensure that the Low Pressure alarm settings accommodate these types of accessories when used in combination with patient circuits.

## **AVERTISSEMENT**

**Accessoires du circuit du patient** - L'utilisation d'accessoires tels que les membranes vocales, les échangeurs thermohydriques et les filtres, produit une résistance additionnelle dans le circuit de patient et en cas de débranchement, elle risque d'empêcher la génération de l'alarme de basse pression. S'assurer que les paramètres de l'alarme de basse pression s'adaptent à ces types d'accessoires lorsqu'ils sont utilisés avec les circuits du patient.



## *NO CAL DATA, NO CAL Monitor Display*

---

When the ventilator detects invalid or missing calibration records on power up, the **NO CAL DATA** alarm is generated. When this happens, default calibration values are used, and although the ventilator will continue to operate, the accuracy of volumes and pressures may be reduced.

A **NO CAL** message is posted in place of affected monitored values when the ventilator is operating without valid transducer calibration data.

### **When the NO CAL DATA alarm occurs:**

- The **NO CAL DATA** message is flashed in the display window.
- The audible alarm is sounded.
- The ventilator continues to operate.
- Default transducer data is used.
- Vte, PIP, MAP, PEEP, and VE monitored values are displayed as **NO CAL**.

### **To clear the NO CAL DATA alarm:**

- 1) Push the **Silence Reset** button twice. This will clear the alarm and the ventilator will continue to operate; however, the **NO CAL** message will still be displayed in place of affected monitored values.
- 2) Take the unit out of service and perform the Calibration procedure<sup>44</sup>.

### **To clear the NO CAL message:**

- 1) Take the unit out of service and perform the Calibration procedure<sup>44</sup>.

## **WARNING**

**NO CAL Condition** - Operation of the LTV<sup>®</sup> 1200 ventilator under a **NO CAL** condition may result in inaccurate pressure and volume measurements. Should this condition occur, disconnect the patient from the ventilator, provide an alternative method of ventilation and immediately contact a certified Pulmonetic Systems' service technician or Pulmonetic Systems, Inc.

## **AVERTISSEMENT**

**Condition NO CAL** - L'opération continue du ventilateur de la 1200 LTV<sup>®</sup> sous condition **NO CAL** peut résulter en mesures de pression et de volume erronées. Si cette condition se présente, le ventilateur doit être retiré du service, et vous devez immédiatement contacter votre technicien de service certifié de Pulmonetic Systems ou Pulmonetic Systems Inc.

---

<sup>44</sup> For more information on the Calibration procedure, see the LTV<sup>®</sup> Series Ventilator's Service Manual, p/n 10665.

## *POWER LOST*

---

When the ventilator is powered up without an external source of power, or is operating on external power and switches to the internal battery, the **POWER LOST** alarm is generated.

- The change to internal battery is made when the external power voltage drops below the usable level.

There is no interruption in ventilation.

### **When a POWER LOST alarm occurs:**

- The **POWER LOST** message is flashed in the display window.
- The **External Power** and **Charge Status** LEDs are turned off.
- The **Battery Level** LED is lit showing the internal battery charge level.
- The ventilator begins operating from the internal battery.
- The audible alarm is sounded.
- After 60 seconds, the displays are turned off to conserve battery power.<sup>45</sup>

### **To reset the POWER LOST alarm:**

- 1) Push the **Silence Reset** button twice.

---

<sup>45</sup> To turn the displays on, push any button or turn the Set Value knob.

## *POWER LOW*

---

When the ventilator is operating on external power and the voltage drops to the low level, the **POWER LOW** alarm is generated.

### **When a POWER LOW alarm occurs:**

- The **POWER LOW** message is flashed in the display window.
- The **External Power** LED is displayed amber.
- The audible alarm is sounded.

### **To reset the POWER LOW alarm:**

- 1) Push the **Silence Reset** button twice.

## REMOVE PTNT

---

When the ventilator is powered up in the Ventilator Checkout or Ventilator Maintenance modes, the **REMOVE PTNT** alarm is generated to remind you to remove the patient from the ventilator before proceeding. Use the Ventilator Checkout mode to check for correct operation of the displays and controls and to check the patient circuit for leaks. Ventilator Maintenance mode is used by technical personnel to perform maintenance or calibration.

### **WARNING**

**Ventilator Checkout and Maintenance Modes** - The LTV<sup>®</sup> 1200 ventilator does not deliver gas during the Ventilator Checkout mode (**VENT CHECK**) or Ventilator Maintenance mode (**VENT MTNCE**) and should not be used to ventilate a patient during these tests.

### **AVERTISSEMENT**

**Modes Vérification et Entretien du ventilateur** - Le ventilateur de la 1200 LTV<sup>®</sup> ne transmet pas le mélange de gaz en mode Vérification du ventilateur (**VENT CHECK**) ou en mode Entretien du ventilateur (**VENT MTNCE**), il ne devrait donc pas être utilisé pour ventiler un patient durant l'exécution de ces tests.

**When you enter Ventilator Checkout mode or Ventilator Maintenance mode, a REMOVE PTNT alarm occurs:**

- The **REMOVE PTNT** message is displayed.
- The audible alarm is sounded.

**To reset the REMOVE PTNT alarm:**

- 1) Push the **Silence Reset** button twice.

## RESET

---

A **RESET** alarm occurs if the ventilator restarts following a condition other than being shut down by pressing the **On/Standby** button.

The ventilator runs an ongoing set of self-tests to verify that it is operating correctly. If the ventilator detects a condition that makes safe ventilator operation uncertain, it reinitializes itself to allow the more sophisticated Power On Self Tests (POST) to be performed. If the POST does not detect any further problems, the ventilator will resume operation and a **RESET** alarm is posted. If the POST detects a problem that could cause continued operation to be unsafe, a ventilator **INOP** will occur.

### Conditions that could cause a RESET alarm:

- Operating the ventilator on the internal battery until it is fully depleted.
- Electrostatic Discharge (ESD)
- Other transient causes.

### When a RESET alarm is generated:

- An error code is written to the Event Trace indicating the type of problem detected.
- The ventilator resets itself and performs the Power On Self Tests (POST).
- If no further problems are detected, the ventilator resumes operation.
- The RESET message is flashed in the display window.
- The audible alarm is sounded.

### To reset the RESET alarm:

- 1) Push the **Silence Reset** button twice.

## NOTE

When a **RESET** alarm has occurred, check the Event Trace for more information about the problem. See *Appendix E - Event Trace* for more information about events.

Repeated occurrences of the **RESET** alarm may indicate a problem with the ventilator's hardware. Please immediately contact a certified Pulmonetic Systems' service technician.

## REMARQUE

Lorsqu'une alarme **Remise à zéro** se produit, vérifiez le suivi de l'événement pour obtenir plus d'informations sur le problème. Consultez l'Annexe E - Suivi de l'événement, pour plus d'informations à propos de l'événement.

Des occurrences répétitives de l'alarme **Remise à zéro** peuvent indiquer un problème matériel avec le ventilateur. Veuillez contacter immédiatement un technicien de service certifié de Pulmonetic Systems.

## *SBT < f*

---

When the Spontaneous Breathing Trial (SBT) mode of ventilation is on and the Total Breath Rate ( *f* ) is less than the **SBT LOW f** setting (low limit of breath rate range) for 30 seconds, the **SBT < f** alarm is generated.

For additional information concerning the Spontaneous Breathing Trial (SBT) mode of ventilation, see *SBT (Spontaneous Breathing Trial) Operations* in Chapter 10 - Extended Features.

### **When a SBT < f alarm is generated:**

- The **SBT < f** message is flashed in the display window.
- The audible alarm is sounded.

### **To reset the SBT < f alarm:**

- 1) Push the **Silence Reset** button once to silence the audible alarm.
- 2) Push the **Silence Reset** button twice to reset the alarm (silences the audible alarm and clears the flashing display).
  - When the **SBT < f** alarm is reset (**Silence Reset** button pushed twice), the alarm is suspended for the next 60 seconds.
  - The 60-second suspension of the **SBT < f** alarm is only enabled when the alarm is manually silenced/reset by pushing the **Silence Reset** button twice. It is not enabled when the **SBT < f** alarm is automatically silenced/reset because the patient's breath rate is no longer less than the set **SBT LOW f** alarm value.
  - When an SBT alarm has been active in excess of 5 minutes, the SBT mode of ventilation is terminated, the ventilator clears the alarm status, silences the audible alarm and returns to its previous mode of ventilation / settings. To remove the flashing SBT alarm message from the display window, push the **Silence Reset** button.

## *SBT > f*

---

When the Spontaneous Breathing Trial (SBT) mode of ventilation is on and the Total Breath Rate ( **f** ) is greater than the **SBT HIGH f** setting (high limit of breath rate range) for 30 seconds, the **SBT > f** alarm is generated.

For additional information concerning the Spontaneous Breathing Trial (SBT) mode of ventilation, see *SBT (Spontaneous Breathing Trial) Operations* in Chapter 10 - Extended Features.

### **When a SBT > f alarm is generated:**

- The **SBT > f** message is flashed in the display window.
- The audible alarm is sounded.

### **To reset the SBT > f alarm:**

- 1) Push the **Silence Reset** button once to silence the audible alarm.
- 2) Push the **Silence Reset** button twice to reset the alarm (silences the audible alarm and clears the flashing display).
  - When the **SBT > f** alarm is reset (**Silence Reset** button pushed twice), the alarm is suspended for the next 60 seconds.
  - The 60-second suspension of the **SBT > f** alarm is only enabled when the alarm is manually silenced/reset by pushing the **Silence Reset** button twice. It is not enabled when the **SBT > f** alarm is automatically silenced/reset because the patient's breath rate is no longer greater than the set **SBT HIGH f** alarm value.
  - When an SBT alarm has been active in excess of 5 minutes, the SBT mode of ventilation is terminated, the ventilator clears the alarm status, silences the audible alarm and returns to its previous mode of ventilation / settings. To remove the flashing SBT alarm message from the display window, push the **Silence Reset** button.

## *SBT < f/Vt*

---

When the Spontaneous Breathing Trial (SBT) mode of ventilation is on and the monitored f/Vt (Total Breath Rate divided by the Average Exhaled Tidal Volume) is less than the **LOW f/Vt** setting (low limit of the f/Vt range) for 30 seconds, the **SBT < f/Vt** alarm\* is generated.

For additional information concerning the Spontaneous Breathing Trial (SBT) mode of ventilation, see *SBT (Spontaneous Breathing Trial) Operations* in Chapter 10 - Extended Features.

### **When a SBT < f/Vt alarm is generated:**

- The **SBT < f/Vt** message is flashed in the display window.
- The audible alarm is sounded.

### **To reset the SBT < f/Vt alarm:**

- 1) Push the **Silence Reset** button twice.
  - When the **SBT < f/Vt** alarm is reset (**Silence Reset** button pushed twice), the alarm is suspended for the next 60 seconds.
  - The 60-second suspension of the **SBT < f/Vt** alarm is only enabled when the alarm is manually silenced/reset by pushing the **Silence Reset** button twice. It is not enabled when the **SBT < f/Vt** alarm is automatically silenced/reset because the patient's breath rate is no longer lower than the set **LOW f/Vt** alarm value.
  - When an SBT alarm has been active in excess of 5 minutes, the SBT mode of ventilation is terminated, the ventilator clears the alarm status, silences the audible alarm and returns to its previous mode of ventilation / settings. To remove the flashing SBT alarm message from the display window, push the **Silence Reset** button.



## *SBT > f/Vt*

---

When the Spontaneous Breathing Trial (SBT) mode of ventilation is on and the monitored f/Vt (Total Breath Rate divided by the Average Exhaled Tidal Volume) is greater than the **HIGH f/Vt** setting (high limit of the f/Vt range) for 30 seconds, the **SBT > f/Vt** alarm\* is generated.

For additional information concerning the Spontaneous Breathing Trial (SBT) mode of ventilation, see *SBT (Spontaneous Breathing Trial) Operations* in Chapter 10 - Extended Features.

### **When a SBT > f/Vt alarm is generated:**

- The **SBT > f/Vt** message is flashed in the display window.
- The audible alarm is sounded.

### **To reset the SBT > f/Vt alarm:**

- 1) Push the **Silence Reset** button once to silence the audible alarm.
- 2) Push the **Silence Reset** button twice to reset the alarm (silences the audible alarm and clears the flashing display).
  - When the **SBT > f/Vt** alarm is reset (**Silence Reset** button pushed twice), the alarm is suspended for the next 60 seconds.
  - The 60-second suspension of the **SBT > f/Vt** alarm is only enabled when the alarm is manually silenced/reset by pushing the **Silence Reset** button twice. It is not enabled when the **SBT > f/Vt** alarm is automatically silenced/reset because the patient's breath rate is no longer greater than the set **HIGH f/Vt** alarm value.
  - When an SBT alarm has been active in excess of 5 minutes, the SBT mode of ventilation is terminated, the ventilator clears the alarm status, silences the audible alarm and returns to its previous mode of ventilation / settings. To remove the flashing SBT alarm message from the display window, push the **Silence Reset** button.

## *SBT OFF*

---

When the minutes preset in the SBT OP, MINUTES menu have elapsed and a Spontaneous Breathing Trial (SBT) mode of ventilation is terminated, the **SBT OFF** alarm is generated.

For additional information concerning the Spontaneous Breathing Trial (SBT) mode of ventilation, see *SBT (Spontaneous Breathing Trial) Operations* in Chapter 10 - Extended Features.

### **When a SBT OFF alarm is generated:**

- The **SBT OFF** message is flashed in the display window.
- The audible alarm is sounded for 3 seconds.

### **To clear the SBT OFF flashing display:**

- 1) Push the **Silence Reset** button.

## *XDCR FAULT*

---

When a transducer autozero test fails, the **XDCR FAULT** alarm is generated. Transducer autozeros are scheduled at periodic intervals during ventilator operation. This allows the ventilator to adjust the zero pressure readings as the ventilator warms up and environmental conditions change. If an autozero test fails, it will be automatically rescheduled to run again on the next breath. The **XDCR FAULT** alarm will remain active until a valid autozero can be done. If the **XDCR FAULT** persists, remove the ventilator from service and immediately contact a certified Pulmonetic Systems' service technician or Pulmonetic Systems.

### **When a XDCR FAULT alarm occurs:**

- The autozero for the transducer is rescheduled to run again on the next breath.
- The **XDCR FAULT** message is flashed in the display window.
- The audible alarm is sounded.

### **To reset the XDCR FAULT alarm:**

- 1) Push the **Silence Reset** button twice.

### **WARNING**

**XDCR FAULT alarm** - Continued operation of the LTV<sup>®</sup> 1200 ventilator with an activated **XDCR FAULT** alarm may result in inaccurate flow and volume measurements. Should this condition occur, disconnect the patient from the ventilator, provide an alternative method of ventilation and immediately contact a certified Pulmonetic Systems' service technician or Pulmonetic Systems, Inc.

### **AVERTISSEMENT**

**Alarme XDCR FAULT** - L'opération continue du ventilateur de la 1200 LTV<sup>®</sup> avec une alarme **XDCR FAULT** activée peut résulter en mesures de débit et de volume erronées. Si cette condition se présente, le ventilateur doit être retiré du service, et vous devez immédiatement contacter votre technicien de service certifié de Pulmonetic Systems ou Pulmonetic Systems Inc.

### **NOTE**

Repeated or continuous **XDCR FAULT** alarms may indicate a problem with the ventilator that could prevent the ventilator from performing within its specifications. Discontinue use of the ventilator and immediately contact a certified Pulmonetic Systems' service technician.

### **REMARQUE**

Des alarmes **XDCR FAULT** répétitives ou continues peuvent indiquer un problème qui pourrait empêcher le ventilateur de fonctionner à l'intérieur des limites spécifiées. Retirer le ventilateur du service, et contactez immédiatement un technicien de service certifié de Pulmonetic Systems.

## *Alarm Status Messages*

---

### *f PEEP OFF*

---

The **f PEEP OFF** message is displayed when;

- The High Breath Rate alarm is turned off by being set to **HIGH f OFF** and,
- The High PEEP alarm is turned off by being set to **HI PEEP OFF**.

This is an informational message only. The message is displayed at power up, when monitored data is being scrolled automatically, and when no front panel activity is detected for 60 seconds.

**To clear the f PEEP OFF message:**

- 1) Push any front panel button or turn the **Set Value** knob.

The **f PEEP OFF** message is not displayed during SBT mode.

### *HI f/Vt OFF*

---

The **HI f/Vt OFF** message is only displayed during the Spontaneous Breath Trial mode of ventilation when the SBT High f/Vt alarm is turned off by being set to **HI f/Vt OFF**.

This is an informational message only. The message is displayed when monitored data is being scrolled automatically, and when no front panel activity is detected for 60 seconds.

**To clear the HI f/Vt OFF message:**

- 1) Push any front panel button or turn the **Set Value** knob.

### *HI PEEP OFF*

---

The **HI PEEP OFF** message is displayed when;

- The High PEEP alarm is turned off by being set to **HI PEEP OFF** and,
- The High Breath Rate alarm (**HIGH f**) is turned on.

This is an informational message only. The message is displayed at power up, when monitored data is being scrolled automatically, and when no front panel activity is detected for 60 seconds.

**To clear the HI PEEP OFF message:**

- 1) Push any front panel button or turn the **Set Value** knob.

## *H&L PEEP OFF*

---

The **H&L PEEP OFF** message is displayed when;

- The High Breath Rate alarm (**HIGH f**) is turned on/set to a value and,
- Both the High PEEP and Low PEEP alarms are turned off

This is an informational message only. The message is displayed at power up, when monitored data is being scrolled automatically, and when no front panel activity is detected for 60 seconds.

### **To clear the H&L PEEP OFF message:**

- 1) Push any front panel button or turn the **Set Value** knob.

## *HIGH f OFF*

---

The **HIGH f OFF** message is displayed when;

- The High Breath Rate alarm is turned off by being set to **HIGH f OFF** and,
- The High PEEP alarm (**HIGH PEEP**) is turned on.

This is an informational message only. The message is displayed at power up, when monitored data is being scrolled automatically, and when no front panel activity is detected for 60 seconds.

### **To clear the HIGH f OFF message:**

- 1) Push any front panel button or turn the **Set Value** knob.

The **HIGH f OFF** message is not displayed during SBT mode.

## *LMV LPPS OFF*

---

The **LMV LPPS OFF** message is displayed when;

- The Low Minute Volume alarm is turned off by being set to dashes and,
- The LPP alarm is set to **VC/PC ONLY**. When this setting is selected, the Low Pressure alarm applies only to Volume Control and Pressure Control breaths.

This is an informational message only. The message is displayed at power up, when monitored data is being scrolled automatically, and when no front panel activity is detected for 60 seconds.

### **To clear the LMV LPPS OFF message:**

- 1) Push any front panel button or turn the **Set Value** knob.

## *LMV OFF*

---

The **LMV OFF** message is displayed when;

- The Low Minute Volume alarm is turned off by being set to dashes and,
- The LPP alarm is set to **ALL BREATHS**.

This is an informational message only. The message is displayed at power up, when monitored data is being scrolled automatically, and when no front panel activity is detected for 60 seconds.

### **To clear the LMV OFF message:**

- 1) Push any front panel button or turn the **Set Value** knob.

## *LO PEEP OFF*

---

The **LO PEEP OFF** message is displayed when;

- The Low PEEP alarm is turned off by being set to **LO PEEP OFF** and,
- The High Breath Rate alarm (**HIGH f**) is turned on/set to a value.

This is an informational message only. The message is displayed at power up, when monitored data is being scrolled automatically, and when no front panel activity is detected for 60 seconds.

### **To clear the LO PEEP OFF message:**

- 1) Push any front panel button or turn the **Set Value** knob.

## *LOCKED*

---

The **LOCKED** message is displayed when a button is pushed while the controls are locked. No audible alarm is given.

### **When a LOCKED message is displayed:**

- The **LOCKED** message is flashed in the display window for 5 seconds or until the controls are unlocked.
- Control settings may not be changed.

There are two methods for unlocking the controls: **EASY** and **HARD**. The unlock method is selected under the Extended Features menus<sup>46</sup>.

### **To unlock the controls with EASY unlocking:**

- 1) Push the **Control Lock** button.

### **To unlock the controls with HARD unlocking:**

- 1) Push and hold the **Control Lock** button for 3 seconds.

---

<sup>46</sup> See *Chapter 10 - Extended Features, Control Unlock* for more information.

## *LO f/Vt OFF*

---

The **LO f/Vt OFF** message is only displayed during the Spontaneous Breath Trial mode of ventilation when the SBT Low f/Vt alarm is turned off by being set to **LO f/Vt OFF**.

This is an informational message only. The message is displayed when monitored data is being scrolled automatically, and when no front panel activity is detected for 60 seconds.

### **To clear the LO f/Vt OFF message:**

- 1) Push any front panel button or turn the **Set Value** knob.

## *LPPS OFF*

---

The **LPPS OFF** message is displayed when;

- The LPPS alarm is set to **VC/PC ONLY** (when this setting is selected, the Low Pressure alarm applies only to Volume Control and Pressure Control breaths), and,
- The LMV alarm is not set to dashes “- -”.

This is an informational message only. The message is displayed at power up, when monitored data is being scrolled automatically, and when no front panel activity is detected for 60 seconds.

### **To clear the LPPS OFF message:**

- 1) Push any front panel button or turn the **Set Value** knob.

## *SBT f OFF*

---

The **SBT f OFF** message is only displayed during the Spontaneous Breath Trial mode of ventilation when;

- The SBT High Breath Rate alarm is turned off by being set to **SBT HI f OFF** and,
- The SBT Low Breath Rate alarm is turned off by being set to **SBT LO f OFF**.

This is an informational message only. The message is displayed when monitored data is being scrolled automatically, and when no front panel activity is detected for 60 seconds.

### **To clear the SBT f OFF message:**

- 1) Push any front panel button or turn the **Set Value** knob.

## *SBT f/Vt OFF*

---

The **SBT f/Vt OFF** message is only displayed during the Spontaneous Breath Trial mode of ventilation when;

- The SBT High f/Vt alarm is turned off by being set to **HI f/Vt OFF** and,
- The SBT Low f/Vt alarm is turned off by being set to **LO f/Vt OFF**.

This is an informational message only. The message is displayed when monitored data is being scrolled automatically, and when no front panel activity is detected for 60 seconds.

### **To clear the SBT f/Vt OFF message:**

- 1) Push any front panel button or turn the **Set Value** knob.

## *SBT HI f OFF*

---

The **SBT HI f OFF** message is only displayed during the Spontaneous Breath Trial mode of ventilation when the SBT High Breath Rate alarm is turned off by being set to **SBT HI f OFF**.

This is an informational message only. The message is displayed when monitored data is being scrolled automatically, and when no front panel activity is detected for 60 seconds.

### **To clear the SBT HI f OFF message:**

- 1) Push any front panel button or turn the **Set Value** knob.

## *SBT LO f OFF*

---

The **SBT LO f OFF** message is only displayed during the Spontaneous Breath Trial mode of ventilation when the SBT Low Breath Rate alarm is turned off by being set to **SBT LO f OFF**.

This is an informational message only. The message is displayed when monitored data is being scrolled automatically, and when no front panel activity is detected for 60 seconds.

### **To clear the SBT LO f OFF message:**

- 1) Push any front panel button or turn the **Set Value** knob.



## *SBT TIME*

---

The **SBT TIME** message is displayed during the Spontaneous Breath Trial mode of ventilation when only two (2) minutes of SBT mode of ventilation remain.

This is an informational message only.

### **When a SBT TIME message is generated:**

- The **SBT TIME** message is flashed in the display window.
- The audible alarm is sounded.

### **To reset the SBT TIME message:**

- 1) Push the **Silence Reset** button once to silence the audible alarm.
- 2) Push the **Silence Reset** button twice to reset the alarm status message (silences the audible alarm and clears the flashing display).

## *WARMUP xx*

---

When the ventilator is first powered up, the transducers require up to 60 seconds of warm-up time before they will operate within their normal tolerances. During this warm-up period, the ventilator will not allow you to run the leak test or calibration. If you select an option that is not available during the warm-up period, the **WARMUP xx** message is displayed. When the warm-up period has expired, the message is removed.

### **When a WARMUP message occurs:**

- The **WARMUP** message and the remaining warm-up time are displayed in the window.
- The ventilator does not allow the restricted functions to be performed.

### **To reset the WARMUP message:**

- 1) The **WARMUP** message will automatically reset when the warm-up period has expired.

# Chapter 10 - EXTENDED FEATURES

This section describes the options and features available under the Extended Features Menus and how to access them.

The Extended Features menus shown below are representative of the LTV<sup>®</sup> 1200 ventilator.

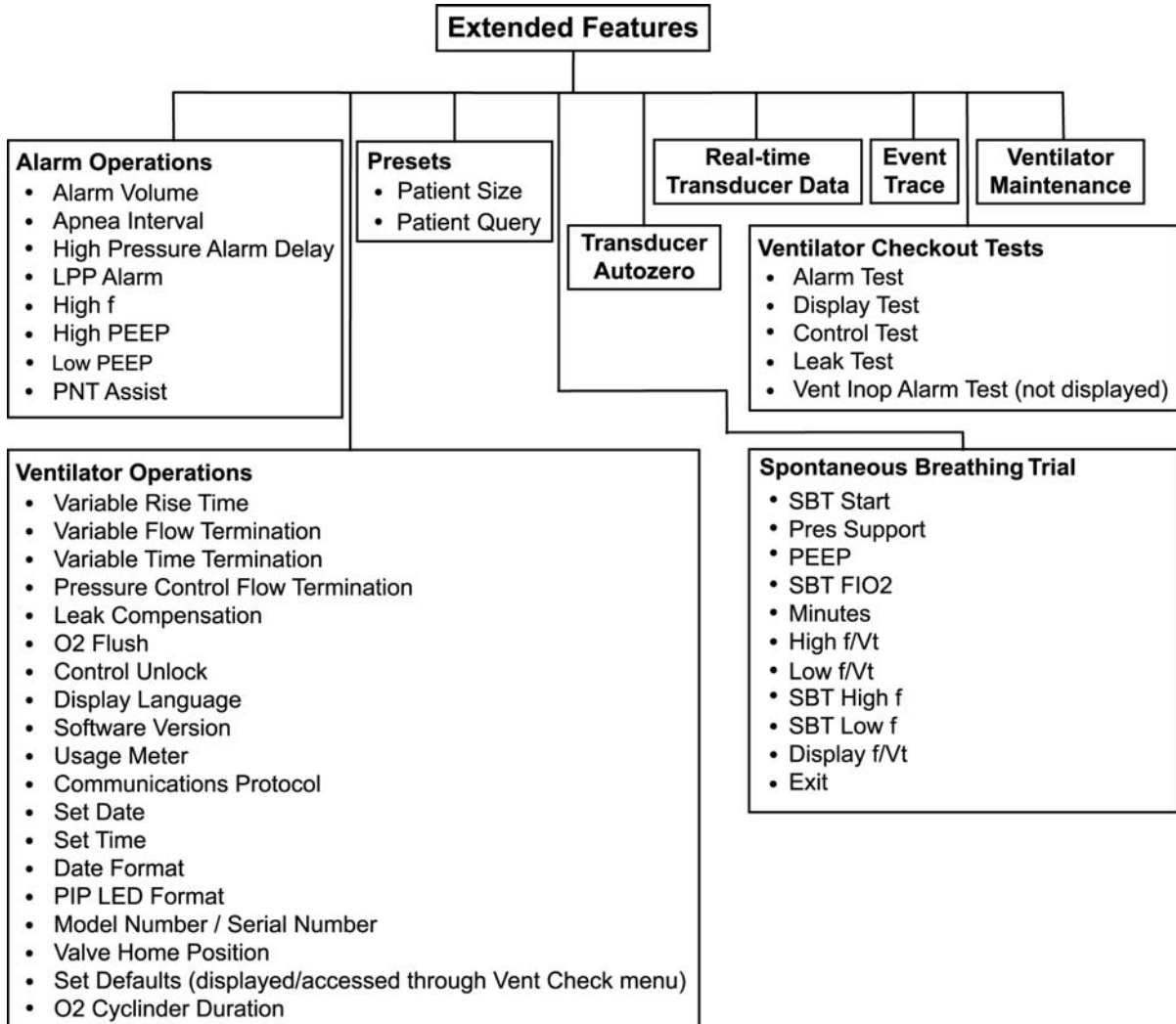

Alarm Operations, Ventilator Operations, Transducer Autozero and Real-time Transducers are covered in this chapter. The other items are covered in *Chapter 11 - Ventilator Checkout Tests*, *Appendix E - Event Trace*, and in the LTV<sup>®</sup> Series Ventilator's Service Manual (P/N 10665).

## *Navigating the Extended Features Menus*

---

**To enter the Extended Features menu** (in normal ventilation mode):

Push and hold the **Select** button for three seconds.

**To view the next item in a menu:**

Turn the **Set Value** knob clockwise.

**To view the previous item:**

Turn the **Set Value** knob counterclockwise.

**To enter a menu item or select a setting:**

Push the **Select** button.

**To exit a menu:**

Turn the **Set Value** knob until the **EXIT** option is displayed, then push the **Select** button.

**To toggle the state of an option on or off:**

Push the **Select** button.

### **NOTE**

You cannot enter the Extended Features menu when the controls are locked.

### **REMARQUE**

Vous ne pouvez pas accéder au menu Fonctions avancées lorsque le verrouillage est activé.

## *Alarm Operations*

---

Use the Alarm Operations menu to set up alarm conditions that are not available directly from front panel controls. The menu is set up as follows:

### **ALARM OP**

**ALARM VOL**

**APNEA INT**

**HP DELAY**

**LPP ALARM**

**HIGH f**

**HIGH PEEP**

**LOW PEEP**

**PNT ASSIST**

**EXIT**

## *Alarm Volume*

---

Use this menu item to set the loudness of the audible alarm.

### **To modify the Alarm Volume:**

- 1) Push the **Select** button while **ALARM VOL** is displayed.
- 2) **VOL xx dBA** is displayed.
- 3) Turn the **Set Value** knob until the desired setting is displayed.
- 4) Push the **Select** button.

**Range:** 60 - 85 dBA at one meter

## **NOTE**

**Fixed Volume Alarms** – The volume of the Battery Empty alarm cannot be lowered. For patient safety, this alarm always sounds at full volume.

If the battery depletes to point that the ventilator goes INOP, the **Vent Inop** audible alarm sounds at maximum volume for a minimum of 5 minutes. The **Vent Inop** audible alarm is capacitor driven and the volume is therefore not user modifiable.

## **REMARQUE**

**Alarmes à volume fixe** - Le volume de l'alarme de batterie faible ne peut être réduit. Pour la sécurité des patients, le volume de cette alarme est toujours fort.

Si la batterie est suffisamment déchargée pour que le voyant INOP du ventilateur s'active, l'alarme sonore **Vent Inop** opérera à son maximum de volume pendant 5 minutes au moins. L'alarme sonore **Vent Inop** est contrôlée par un condensateur et son volume ne peut donc pas être modifié par l'utilisateur..

## *Apnea Interval*

---

Use this menu item to establish the apnea interval. The apnea interval is the maximum time allowed between the beginning of one breath and the beginning of the next breath.

### **To modify the Apnea Interval:**

- 1) Push the **Select** button while **APNEA INT** is displayed.
- 2) **APNEA xx sec** is displayed.
- 3) Turn the **Set Value** knob until the desired setting is displayed.
- 4) Push the **Select** button.

**Range:** 10 - 60 sec

## *High Pressure Alarm Delay*

---

Use this menu item to select immediate or delayed audible notification for High Pressure alarms. When **NO DELAY** is selected, the audible alarm is sounded for all High Pressure alarms.

When **DELAY 1 BRTH** or **DELAY 2 BRTH** is selected and a high pressure condition occurs, the breath is terminated and the **HIGH PRES** message is posted. The audible alarm is not sounded until the number of consecutive breaths with a high pressure condition meets the delay setting, (two breaths for **DELAY 1**, three breaths for **DELAY 2**).

Any time a high pressure condition persists for more than 3 seconds, the audible alarm will be sounded, regardless of the delay setting.

### **To modify the High Pressure Alarm Display:**

- 1) Push the **Select** button while **HP DELAY** is displayed.
- 2) **NO DELAY**, **DELAY 1 BRTH**, or **DELAY 2 BRTH** is displayed.
- 3) Turn the **Set Value** knob until the desired setting is displayed.
- 4) Push the **Select** button.

**Options:** NO DELAY, DELAY 1 BRTH, DELAY 2 BRTH

## *Low Peak Pressure Alarm*

---

Use the **LPP ALARM** item to select the type of breaths that the Low Pressure alarm applies to.

When **ALL BREATHS** is selected, the **Low Pressure** alarm setting applies to all breath types: Volume Control, Pressure Control, Pressure Support, and Spontaneous. When the peak pressure during any breath does not exceed the **Low Pressure** setting, the **LOW PRES** alarm will occur.

When **VC/PC ONLY** is selected, the **Low Pressure** alarm setting applies only to Volume Control and Pressure Control breaths. It does not apply to Pressure Support and Spontaneous breaths. When the peak pressure during any Volume Control or Pressure Control breath does not exceed the **Low Pressure** setting, the **LOW PRES** alarm will occur.

**Options:** ALL BREATHS, VC/PC ONLY

## High f

---

Use this menu item to set the high breath rate and time period alarm values. When the Total Breath Rate ( f ) exceeds the set high breath rate and time period alarm values, an audible alarm will be sounded and a flashing **HIGH f** message will be displayed.

### To set the high breath rate and time period alarm values:

- 1) Push the **Select** button while **HIGH f** is displayed and **f** is displayed.
- 2) Push the **Select** button while **f** is displayed and **HIGH f OFF** or **f xx bpm** is displayed.
- 3) Turn the **Set Value** knob until the desired setting is displayed, push the **Select** button and the high breath rate alarm value is set.
  - **Range:** 5 - 80 bpm (in increments of 1) - HIGH f OFF
- 4) Turn the **Set Value** knob until **TIME** is displayed, push the **Select** button and **xx sec** is displayed.
- 5) Turn the **Set Value** knob until the desired setting is displayed and push the **Select** button. The high breath rate time period alarm value is set.
  - **Range:** 0 - 60 seconds, in increments of 10

## High PEEP

---

Use this menu item to set a high PEEP alarm. When the current PEEP value exceeds the set high PEEP alarm value, an audible alarm will be sounded and a flashing **HIGH PEEP** message will be displayed.

### To modify the HIGH PEEP alarm value:

- 1) Push the **Select** button while **HIGH PEEP** is displayed.
- 2) **HI PEEP OFF** or **PEEP +XX cmH<sub>2</sub>O** is displayed.
- 3) Turn the **Set Value** knob until the desired setting is displayed.
- 4) Push the **Select** button.

**Range:** PEEP +3 through PEEP +20 cmH<sub>2</sub>O, HI PEEP OFF

## Low PEEP

---

Use this menu item to set a low PEEP alarm. When the current PEEP value is less than the set low PEEP alarm value, an audible alarm will be sounded and a flashing **LOW PEEP** message will be displayed.

### To modify the LOW PEEP alarm value:

- 1) Push the **Select** button while **LOW PEEP** is displayed.
- 2) **LO PEEP OFF** or **PEEP -XX cmH<sub>2</sub>O** is displayed.
- 3) Turn the **Set Value** knob until the desired setting is displayed.
- 4) Push the **Select** button.

**Range:** PEEP -3 through PEEP -20 cmH<sub>2</sub>O, LO PEEP OFF

## *Patient Assist*

---

Use the **PNT ASSIST** menu item to configure the Patient Assist port output signal to be generated for use with remote alarm systems.

- Allows for the changing of the patient assist alarm output signal used with remote alarm systems, which in turn will allow users a means of distinguishing the high pressure alarm (**HIGH PRES**) from other alarms.

### **To select the Patient Assist output signal:**

- 1) Push the **Select** button while **PNT ASSIST** is displayed.
- 2) **NORMAL** or **PULSE** is displayed.
  - When **NORMAL** is selected, the ventilator sets the Patient Assist Port output signal continuously on for all alarms and is for use with single tone remote alarm and patient assist call systems. **NORMAL** is the factory set default setting.
  - When **PULSE** is selected, the ventilator sets the Patient Assist Port output signal continuous on for the **HIGH PRES** alarm, cycles the Patient Assist output signal on / off for all other alarms and is for use with dual tone remote alarm systems.
- 3) Turn the **Set Value** knob until the desired setting is displayed.
- 4) Push the **Select** button.

**Range:** PULSE or NORMAL

## *Exit*

---

### **To return to the top of the ALARM OP menu:**

- 1) Push the **Select** button while **EXIT** is displayed.

## *Vent Operations*

---

Use the Vent Operations menu to set up ventilator controls and options that are not available directly from front panel controls. The menu is set up as follows:

### **VENT OP**

**RISE TIME**

**FLOW TERM**

**TIME TERM**

**PC FLOW TERM**

**LEAK COMP**

**O2 FLUSH**

**CTRL UNLOCK**

**LANGUAGE**

**VER xx.xx**

**USAGE xxxxx.x**

**COM SETTING**

**SET DATE**

**SET TIME**

**DATE FORMAT**

**PIP LED**

**LTV xxxx / xxxxxx**

**VHome xxx**

**SET DEFAULTS** (accessed through Vent Check menu)

**O2 CYL DUR**

**EXIT**



## Variable Rise Time

---

Use the Variable Rise Time option to select the rise time profile for Pressure Control and Pressure Support breaths. The rise time profiles are numbered 1 through 9 where 1 is the fastest rise time and 9 is the slowest rise time. Starting with the fastest rise time, each time is 33% longer than the previous one.

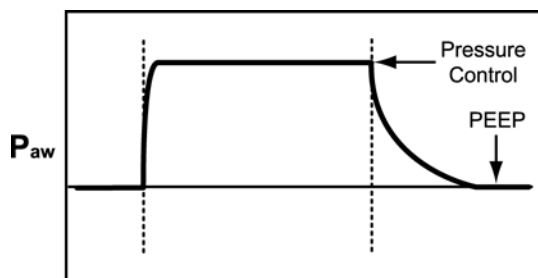

**Profile #1 - Faster Rise Time**

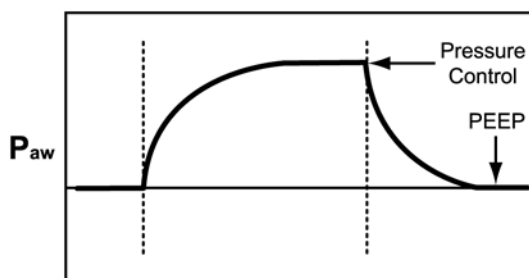

**Profile #9 - Slower Rise Time**

### To modify the Rise Time Profile:

- 1) Push the **Select** button while **RISE TIME** is displayed.
- 2) **PROFILE x** is displayed.
- 3) Turn the **Set Value** knob until the desired Rise Time Profile is displayed.
- 4) Push the **Select** button.

**Range:** 1 to 9, where 1 is the fastest and 9 is the slowest

## Variable Flow Termination

---

Use the Variable Flow Termination to select the percentage of peak flow used for cycling Pressure Support breaths. Pressure Support breaths are cycled from inspiration to exhalation when the flow reaches the set percentage of the peak flow, or when flow goes below 2 lpm.

When Pressure Control Flow Termination is enabled, the Variable Flow Termination setting is used for flow termination of Pressure Control breaths as well.

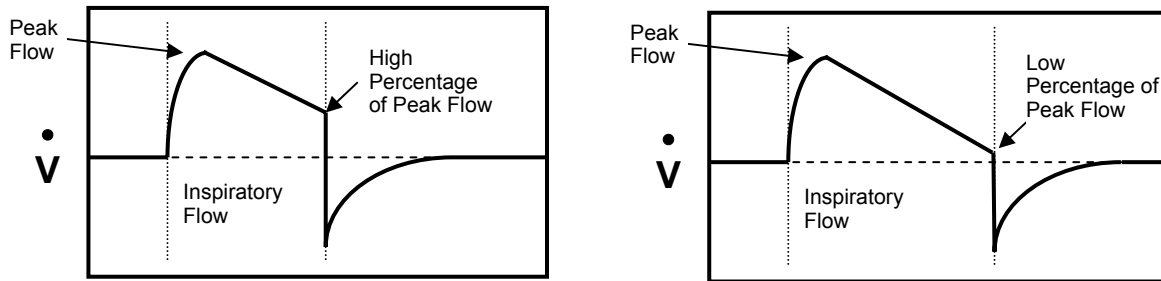

### To modify the Variable Flow Termination:

- 1) Push the **Select** button while **FLOW TERM** is displayed.
- 2) **% OF PEAK xx** is displayed.
- 3) Turn the **Set Value** knob until the desired Variable Flow Termination percentage is displayed.
- 4) Push the **Select** button.

**Range:** 10% to 40%

## Variable Time Termination

---

Use the Variable Time Termination to select the maximum inspiratory time for cycling Pressure Support breaths. Pressure Support Breaths are cycled from inspiration to exhalation if this time is reached before the flow reaches the set percentage of the peak flow. When a breath is cycled based on the time setting, the **Pres. Support** display is flashed briefly.

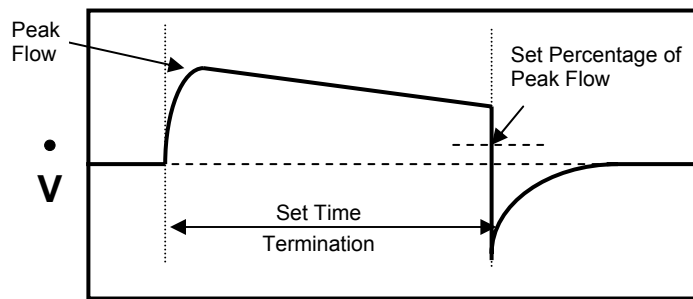

### To modify the Variable Time Termination:

- 1) Push the **Select** button while **TIME TERM** is displayed.
- 2) **TERM x.x sec** is displayed.
- 3) Turn the **Set Value** knob until the desired Variable Time Termination is displayed.
- 4) Push the **Select** button.

**Range:** 0.3 to 3.0 sec

## Pressure Control Flow Termination

Use the Pressure Control Flow Termination option to enable or disable flow termination for Pressure Control breaths.

When this option is **ON**, Pressure Control breaths are cycled at the set percentage of the peak flow if it is reached before the set Inspiratory Time elapses. The percentage of peak flow is set in the Variable Flow Termination option.

When this option is **OFF**, Pressure Control breaths are cycled when the set Inspiratory Time is reached.

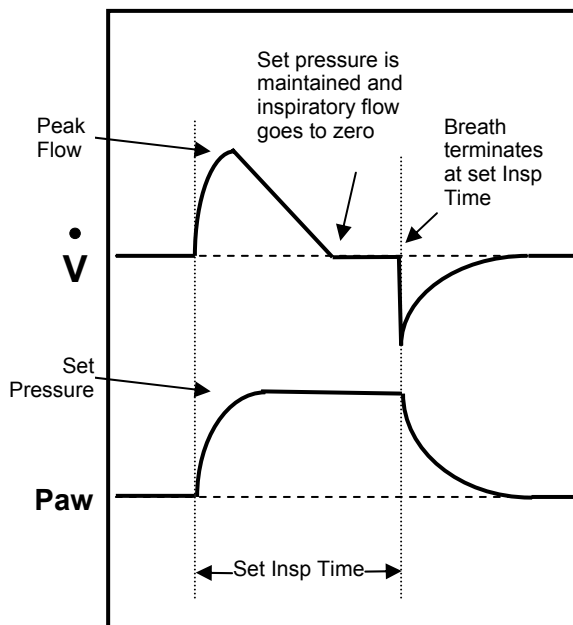

### PC FLOW TERM set to OFF

Pressure Control Breath terminates normally

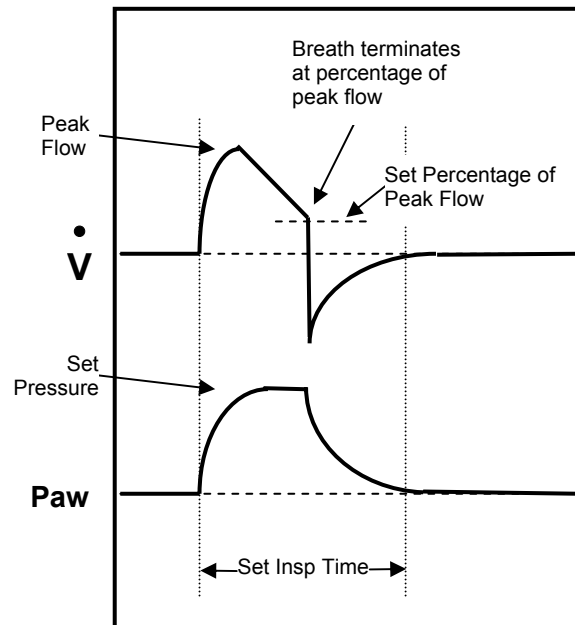

### PC FLOW TERM set to ON

Pressure Control Breath terminates at the same Percentage of Peak Flow as Pressure Support breaths

### To modify the Pressure Control Flow Termination setting:

- 1) Push the **Select** button while **PC FLOW TERM** is displayed.
- 2) **PC FLOW ON** or **PC FLOW OFF** is displayed.
- 3) Turn the **Set Value** knob until the desired state is displayed.
- 4) Push the **Select** button.

**Options:** ON or OFF

## Leak Compensation

Use the Leak Compensation option to enable or disable tracking of the baseline flow<sup>47</sup> to improve triggering when a circuit leak is present.

When Leak Compensation is on, the system is gradually adjusted to maintain set sensitivity if the leak is stable and there is no autocycling.

- If a leak is unstable during exhalation, it will not be detected and will not be compensated for.
- Leak Compensation can compensate for a maximum patient circuit leak of 6 Lpm.

### If autocycling is occurring, it can be manually eliminated as follows:

- 1) Set **Sensitivity** to **OFF** (see *Chapter 6 - Sensitivity*), or higher than the leak amount (see *Chapter 10 - Real Time Transducers, LEAK xx.xx Lpm*).
- 2) Set Leak Compensation to **LEAK COMP ON** (see instructions below).
- 3) Wait for a period of 10-15 breaths.
- 4) Reset sensitivity to desired level (see *Chapter 6 - Sensitivity*).

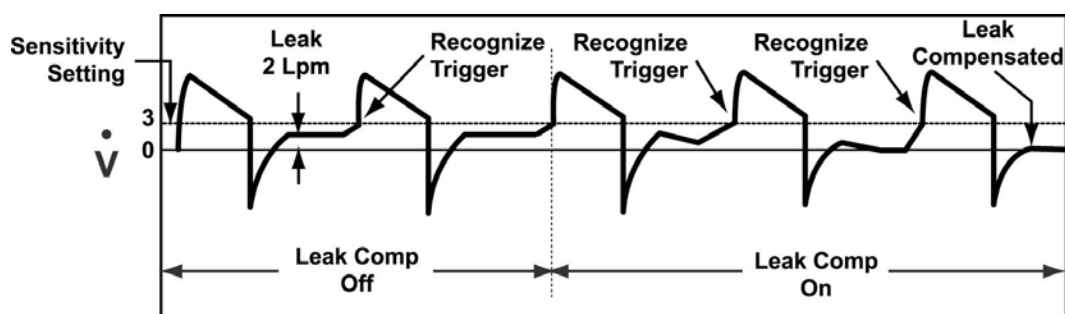

Leak Compensation - Off to On

### To modify the Leak Compensation setting:

- 1) Push the **Select** button while **LEAK COMP** is displayed.
- 2) **LEAK COMP ON** or **LEAK COMP OFF** is displayed.
- 3) Turn the **Set Value** knob until the desired state is displayed.
- 4) Push the **Select** button.

**Options:** ON or OFF

<sup>47</sup> Baseline flow is used for flow triggering detection and Vte calculation/accumulation.

## *O<sub>2</sub> Flush*

---

Use the O<sub>2</sub> Flush option to elevate the delivered FIO<sub>2</sub> to 100% for a preset period of time.

### **To initiate an O<sub>2</sub> Flush:**

- 1) Push and hold the **O<sub>2</sub> % (O<sub>2</sub> Flush)** button (FIO<sub>2</sub>) on the ventilator front panel for three seconds to initiate the elevation (ramp up) of delivered FIO<sub>2</sub> to 100% for the preset number of minutes.
  - The FIO<sub>2</sub> percentile displayed will change to 100 and the O<sub>2</sub> Flush maneuver will start immediately (regardless of the current ventilation mode, breath rate or phase).
    - O<sub>2</sub> Flush will not be initiated if Low Pressure O<sub>2</sub> Source is selected.
  - O<sub>2</sub> Flush will stop when the preset minutes have elapsed or the **O<sub>2</sub> % (O<sub>2</sub> Flush)** button is pushed again.
  - When stopped, the delivered FIO<sub>2</sub> percentile will return (ramp down) to the preset O<sub>2</sub> % setting.

### **To modify the O<sub>2</sub> Flush setting:**

- 1) Push the **Select** button while **O<sub>2</sub> FLUSH** is displayed and **xxx min** is displayed.
- 2) Turn the **Set Value** knob until the desired amount of minutes is displayed and push the **Select** button. The O<sub>2</sub> Flush time period is set.

**Range:** 1 to 3 minutes, in increments of 1

## *Control Unlock*

---

Use the Control Unlock option to select the Easy or Hard unlocking method for unlocking the controls. The Easy unlocking method should be used when only trained personnel have access to the ventilator. The Hard method should be used when children or others may have access to the ventilator and you want to prevent accidental changes to the control settings.

When the Easy method is selected, unlock the controls by pushing the **Control Lock** button.

When the Hard method is selected, unlock the controls by pushing and holding the **Control Lock** button for 3 seconds.

### **To modify the Control Unlock setting:**

- 1) Push the **Select** button while **CTRL UNLOCK** is displayed.
- 2) **UNLOCK EASY** or **UNLOCK HARD** is displayed.
- 3) Turn the **Set Value** knob until the desired setting is displayed.
- 4) Push the **Select** button.

**Options:** EASY or HARD

## *Language Selection*

---

Use the Language Selection option to select the language used in the display window for all messages, alarms and menus.

### **To modify the Language setting:**

- 1) Push the **Select** button while **LANGUAGE** is displayed.
- 2) **ENGLISH** or the currently selected language is displayed.
- 3) Turn the **Set Value** knob until the desired language is displayed.
- 4) Push the **Select** button.

### **Options:**

ENGLISH (U.S.)	DANSK (Danish)	DEUTCH (German)	ESPANOL (Spanish)	FRANCAIS (French)
ITALIANO (Italian)	NORSK (Norwegian)	PORTUGUES (Portuguese)	SVENSKA (Swedish)	PYCCKO (Russian)

## *Software Version*

---

Use the Software Version option to verify the software version installed in the ventilator. The software version number is displayed as: **VER xx.xx**

## *Usage Meter*

---

Use the Usage Meter to view the time the ventilator has been in use. It is updated every 1/10<sup>th</sup> hour up to 139,000.0 hours and is displayed as: **USAGE xxxxxx.x**

## *Communications Setting*

---

The ventilator may be connected to a printer, a graphics monitor, or a modem, or may be set up to output system diagnostic data. Use the Communications Setting option<sup>48</sup> to select the communications protocol for data transmission.

- Use the **MONITOR** setting to communicate with an LTM Graphics Monitor.

### **To modify the Communications Setting:**

- 1) Push the **Select** button while **COM SETTING** is displayed.
- 2) **DATA** or the currently selected protocol is displayed.
- 3) Turn the **Set Value** knob until the desired protocol is displayed.
- 4) Push the **Select** button.

**Options:** DATA, MONITOR, PRINTER, and MODEM

---

<sup>48</sup> Only **DATA** and **MONITOR** (for LTM Graphic Monitors compatible LTV<sup>®</sup> ventilators) are available at this time.



## *Set Date*

---

Use the Set Date option to view or set the current date stored in the ventilator.

### **To view the Date:**

- 1) Push the **Select** button while **SET DATE** is displayed.
- 2) The current date is displayed in the currently selected date format.
- 3) Push the **Control Lock** button to exit.

### **To modify the Date:**

- 1) Push the **Select** button while **SET DATE** is displayed.
- 2) The current date is displayed in the currently selected date format (**MM/DD/YYYY**, **DD/MM/YYYY**, or **YYYY/MM/DD**).
- 3) Push the **Select** button, **YEAR xxxx** is displayed.
- 4) Turn the **Set Value** knob until the desired year is displayed.
- 5) Push the **Select** button, **MONTH xx** is displayed.
- 6) Turn the **Set Value** knob until the desired month is displayed.
- 7) Push the **Select** button, **DAY xx** is displayed.
- 8) Turn the **Set Value** knob until the desired day is displayed.
- 9) Push the **Select** button to accept the new date.

**Range:** 1/1/1998 - 12/31/2097

## *Set Time*

---

Use the Set Time option to view or set the current time stored in the ventilator.

### **To view the Time:**

- 1) Push the **Select** button while **SET TIME** is displayed.
- 2) The current time is displayed.
- 3) Push the **Control Lock** button to exit.

### **To modify the Time:**

- 1) Push the **Select** button while **SET TIME** is displayed.
- 2) The current date is displayed as **hh:mm:ss**.
- 3) Push the **Select** button, **HOUR xx** is displayed.
- 4) Turn the **Set Value** knob until the desired hour is displayed.
- 5) Push the **Select** button, **MIN xx** is displayed.
- 6) Turn the **Set Value** knob until the desired minute is displayed.
- 7) Push the **Select** button to accept the new date. The seconds are automatically reset to 00.

**Range:** 00:00:00 - 23:59:59

## *Date Format*

---

Use the Date Format option to select the display format for the current date.

### **To modify the Date Format:**

- 1) Push the **Select** button while **DATE FORMAT** is displayed.
- 2) **MM/DD/YYYY** or the currently selected date format is displayed.
- 3) Turn the **Set Value** knob until the desired format is displayed.
- 4) Push the **Select** button.

**Options:** MM/DD/YYYY, DD/MM/YYYY, YYYY/MM/DD

## *PIP LED*

---

Use the PIP LED option to turn the display of the **PIP LED** on the airway display on or off. When the PIP LED is on, the **Airway Pressure** display LED representing the Peak Inspiratory Pressure of the previous breath remains lit during exhalation.

### **To modify the PIP LED Setting:**

- 1) Push the **Select** button while **PIP LED** is displayed.
- 2) **PIP LED ON** or **PIP LED OFF** is displayed.
- 3) Turn the **Set Value** knob until the desired setting is displayed.
- 4) Push the **Select** button.

**Options:** ON or OFF

## *Model Number / Serial Number*

---

Use the Model Number / Serial Number option to view the LTV's model or serial number, and to verify LTM Graphics Monitor compatibility.

### **To view the LTV model number:**

- 1) Turn the **Set Value** knob while in the **VENT OP** menu until **LTV xxxx** is displayed.
  - The model number is displayed as: **LTV xxxx** where **xxxx** is the model of the ventilator.
  - The model number is set when the ventilator is manufactured.
- 2) Push the **Control Lock** button to exit, or the **Select** button to display the serial number option.

### **To view the LTV serial number:**

- 1) Push the **Select** button when the LTV model number (**LTV xxxx**) is displayed.
  - The serial number is displayed on the left side of the display area as: **xxxxxxx** where **xxxxxxx** is the serial number of the ventilator.
  - The serial number is set when the ventilator is manufactured.
- 2) Push the **Control Lock** button or the **Select** button to return to the model number option.

### **To verify LTM Graphics Monitor Compatibility:**

- 1) Push the **Select** button when the LTV model number (**LTV xxxx**) is displayed.
  - The message **LTM** will be displayed on the right side of the display area if the ventilator was originally manufactured or upgraded by Pulmonetic Systems to accommodate the LTM Graphics Monitor.
- 2) Push the **Control Lock** button or the **Select** button to return to the model number option.

## Valve Home Position

---

Use the Valve Home Position option to view the home position for the LTV's flow valve. The home position is displayed as: **VHome xxx** where **xxx** is the home position for the valve installed in the ventilator.

The home position is determined by the revision of the flow valve and is set when the ventilator is manufactured or when the flow valve is replaced by a certified Pulmonetic Systems' service technician.

## Set Defaults

---

The SET DEFAULTS option is only displayed and accessed through the Ventilator Checkout menu (**VENT CHECK**) or Ventilator Maintenance menu (**VENT MTNCE**) and is used to reset user settable Controls and Extended Features settings to their factory-set default values. See *Chapter 9 - Ventilator Alarms, DEFAULTS* for factory-set default values.

### To enable the Ventilator Checkout menu:

To enable the Ventilator Checkout menu, the patient must be disconnected from the ventilator (ventilate the patient using an alternative method of ventilation), the ventilator must be turned off, and a special power on sequence used to turn it back on. See *Chapter 11 - Ventilator Checkout Tests* for important information and instructions, prior to proceeding.

### To set the default values:

- 1) When the **VENT CHECK** menu is displayed, turn the **Set Value** knob until **VENT OP** is displayed and push **Select**.
- 2) Turn the **Set Value** knob until **DEFAULTS** is displayed and push **Select**. **SET DEFAULTS** will be displayed.
- 3) Push **Select** while **SET DEFAULTS** is displayed. **DEFAULTS** will be displayed.
  - Except for the Language selected and the Date/Time settings and format, all user settable Controls and Extended Features options are reset to their factory-set default values.
  - A **DEFAULTS** event is recorded in the Event Trace log (see *Appendix E - Event Trace* for additional information) along with the date and time the settings were reset.

### To exit the Ventilator Checkout menu and enter normal ventilation mode:

- 1) Turn the **Set Value** knob through the Ventilator Operations sub-menus until **EXIT** is displayed, and push the **Select** or **Control Lock** button. **VENT OP** will be displayed.
- 2) When **VENT OP** is displayed, turn the **Set Value** knob until **EXIT** is displayed, and push the **Select** or **Control Lock** button.
  - POST will be performed, the ventilator will begin ventilation using the factory set default settings and a **DEFAULTS SET** alarm will be generated (see *Chapter 9 - Ventilator Alarms, DEFAULTS SET* for additional information and instructions to reset the **DEFAULTS SET** alarm).

## *O<sub>2</sub> Cylinder Duration*

---

Use the O<sub>2</sub> Cylinder Duration option to calculate the approximate remaining usable time (in hours and minutes) of an external O<sub>2</sub> cylinder.

- To obtain an accurate duration time estimate, the current cylinder pressure must be entered prior to *each* calculation.

### **WARNING**

**O<sub>2</sub> Cylinder Duration Information** - The accuracy of the displayed useable amount of oxygen remaining in an external O<sub>2</sub> cylinder (**O2 DUR hh:mm**) is dependant on the precision of the pressure gauge used on the O<sub>2</sub> cylinder and the accuracy of the information provided by the operator in the **O2 CYL DUR** menu settings. The calculated/displayed useable amount of oxygen information is to be used for reference purposes only.

**Ventilation Variables and O<sub>2</sub> Consumption** - Variations in the patient's minute ventilation, I:E ratio and/or ventilator setting changes or equipment status (i.e. circuit leaks) affect the consumption rate of oxygen. When warranted by a patients condition, it is recommended that a back-up cylinder or alternative source of oxygen be available at all times.

### **AVERTISSEMENT**

**Informations sur la durée d'utilisation restante de la bouteille d'oxygène** - La précision de l'affichage de la quantité d'oxygène utilisable restante dans une bouteille d'oxygène externe (**O2 DUR HH:MM**) dépend de la précision de la jauge de pression utilisée sur la bouteille et de l'exactitude des informations fournies par l'opérateur dans les paramètres du menu **DUREE CYL O2**. Les informations calculées et affichées sur la quantité d'oxygène utilisable ne doivent être utilisées qu'à titre indicatif.

**Variables de ventilation et consommation d'oxygène** — Les variations dans la ventilation par minute du patient et dans le rapport inspiration/expiration, la modification des paramètres ou l'état du matériel (fuite dans le circuit, par exemple) modifient le taux de consommation de l'oxygène. Lorsque la situation du patient le permet, il est recommandé qu'une bouteille d'oxygène de secours ou toute autre source alternative d'oxygène soit disponible en permanence.

#### **To modify the O<sub>2</sub> Cylinder Duration settings:**

- 1) Push the **Select** button while **O2 CYL DUR** is displayed and **CYL TYPE** is displayed.
- 2) Push the **Select** button while **CYL TYPE** is displayed and **SIZE xxx l** is displayed.
- 3) Turn the **Set Value** knob until the applicable O<sub>2</sub> cylinder size is displayed (volume in compressed Liters), push the **Select** button and the cylinder size is set.
  - **Range:** 75 - 9,900 compressed Liters, in increments of 1.
  - This setting is retained by the ventilator (through shut downs and power ups) until re-set by an operator, and used to calculate the remaining oxygen.
  - After changing this, or *any* ventilation setting, wait approximately 20 seconds before selecting **CALCULATE**, to allow the ventilator to monitor the oxygen flow that will be used in the calculation and display of the remaining usable time of the external O<sub>2</sub> cylinder.

### O<sub>2</sub> Cylinder Duration (cont.)

- 4) Turn the **Set Value** knob until **CYL PRES** is displayed, push the **Select** button and **xxx psi** is displayed.
- 5) Turn the **Set Value** knob until the applicable cylinder pressure is displayed, push the **Select** button and the cylinder pressure is set.
  - **Range:** 100 - 2300 psi, in increments of 25, **or**
  - **Range:** 5 - 150 bar, in increments of 1 (if the selected language uses the bar unit of measurement)
  - This setting is not retained by the ventilator through shut downs and power ups, will be reset to the factory set default value if the Language setting is changed, and will need to be reviewed/reset by the operator each time the O<sub>2</sub> Cylinder Duration option is used.
  - After changing this, or any ventilation setting, wait approximately 20 seconds before selecting **CALCULATE**, to allow the ventilator to monitor the oxygen flow that will be used in the calculation and display of the remaining usable time of the external O<sub>2</sub> cylinder.
- 6) Turn the **Set Value** knob until **CALCULATE** is displayed and push the **Select** button.
  - To obtain an accurate duration time estimate, the current cylinder pressure must be entered prior to each calculation.
  - After changing any ventilation setting, wait approximately 20 seconds before selecting **CALCULATE**, to allow the ventilator to monitor the oxygen flow that will be used in the calculation and display of the remaining usable time of the external O<sub>2</sub> cylinder.
  - When **CALCULATE** is selected, the ventilator uses the current ventilation values and settings to calculate the remaining usable time of the external O<sub>2</sub> cylinder specified and displays **O2 DUR hh:mm** (O<sub>2</sub> duration in hours and minutes) for 60 seconds or until the message is acknowledged by pushing the **Select** or **Control Lock** button, or by rotating the **Set Value** knob on the front panel.
  - Breath to breath variations may cause slightly different results in consecutive calculations.

## Presets

---

Use the Presets section of the Extended Features menu to:

- Turn the Patient Query feature on or off
- Select the Patient Size so that the ventilator settings and Extended Features menu settings are adjusted to accommodate the type of patient (infant, pediatric or adult)

### Turning Patient Query on or off

---

- 1) After entering the Extended Features menu, turn the **Set Value** knob until **PRESETS** is displayed and press the **Select** button.
- 2) Turn the **Set Value** knob until **PTNT QUERY** is displayed, press the **Select** button and either **QUERY ON** or **QUERY OFF** is displayed.
- 3) Turn the **Set Value** knob until the desired setting is displayed and press the **Select** button.

If **QUERY ON** is selected, when the ventilator is next powered up and passes POST, ventilation and alarm activation are suspended and the message **SAME PATIENT** is displayed.

- To enable the suspended alarms and begin ventilation with the settings in use during the last power cycle, press the **Select** button while **SAME PATIENT** is displayed

OR

- To enable the suspended alarms and begin ventilation with Presets values appropriate for a new patient, turn the **Set Value** knob until **NEW PATIENT** is displayed and press the **Select** button. Then turn the **Set Value** knob until the desired patient type is displayed (**INFANT**, **PEDIATRIC** or **ADULT**) and press the **Select** button

- Turning the **Set Value** knob until **EXIT** is displayed and pressing the **Select** button returns the ventilator to the **SAME PATIENT** menu option/message

If no controls are activated for three (3) seconds while either the **SAME PATIENT** or **NEW PATIENT** options are being displayed, an audible alert sounds. Activation of any control resets the 3 second delay of the audible alert.

If **QUERY OFF** is selected, when the ventilator is powered up and passes POST, it will begin ventilation (appropriate alarms enabled) using the settings in use during the last power cycle.

### Selecting Patient Size

---

- 1) After entering the Extended Features menu, turn the **Set Value** knob until **PRESETS** is displayed.
- 2) Press the **Select** button.
- 3) Turn the **Set Value** knob until **PATIENT SIZE** is displayed and press the **Select** button.
- 4) Turn the **Set Value** knob until the desired patient type is displayed (**INFANT**, **PEDIATRIC** or **ADULT**) and press the **Select** button to set the Presets values appropriate for the patient type selected.

*LTV® 1200 Presets Table*

<b>Feature/Function</b>	<b>Infant (&gt;5 kg &lt; 10 kg)</b>	<b>Pediatric (10-40 kg)</b>	<b>Adult (&gt; 40 kg)</b>
Alarm volume	85	85	85
HP delay	NO DELAY	NO DELAY	NO DELAY
LPP alarm	ALL BREATHS	ALL BREATHS	ALL BREATHS
High f alarm	80 bpm, 30 sec	60 bpm, 30 sec	40 bpm, 30 sec
High PEEP alarm	PEEP +5 cmH <sub>2</sub> O	PEEP +5 cmH <sub>2</sub> O	PEEP +5 cmH <sub>2</sub> O
Low PEEP alarm	PEEP -3 cmH <sub>2</sub> O	PEEP -3 cmH <sub>2</sub> O	PEEP -3 cmH <sub>2</sub> O
Rise Time	5	4	4
FLOW TERM	35%	30%	25%
TIME TERM	TERM 0.5 sec	TERM 1.0 sec	TERM 2.0 sec
PC FLOW TERM	Off	Off	Off
Leak Comp	LEAK COMP ON	LEAK COMP ON	LEAK COMP ON
Breath Rate	20 bpm	15 bpm	12 bpm
Breath type	Pressure	Pressure	Volume
Tidal Volume	50 ml	250 ml	500 ml
Insp. Time	0.3 sec	0.7 sec	1.0 sec
Pres. Control	15 cmH <sub>2</sub> O	15 cmH <sub>2</sub> O	15 cmH <sub>2</sub> O
Pres. Support	10 cmH <sub>2</sub> O	10 cmH <sub>2</sub> O	10 cmH <sub>2</sub> O
Sensitivity	2 Lpm	3 Lpm	3 Lpm
High Pres. Limit	30 cmH <sub>2</sub> O	30 cmH <sub>2</sub> O	40 cmH <sub>2</sub> O
Low Pressure	10 cmH <sub>2</sub> O	10 cmH <sub>2</sub> O	10 cmH <sub>2</sub> O
Low Min. Vol.	0.5 ml	1.0 ml	3.0 ml
PEEP	0 cmH <sub>2</sub> O	0 cmH <sub>2</sub> O	0 cmH <sub>2</sub> O
Mode	Assist/Ctrl	Assist/Ctrl	Assist/Ctrl



## *SBT (Spontaneous Breathing Trial) Operations*

---

Use the SBT Operations menu to set up ventilator controls and options that are not available directly from front panel controls. The menu is set up as follows:

### **SBT OP**

**SBT START**  
**PRES SUPPORT**  
**PEEP**  
**SBT FIO2**  
**MINUTES**  
**HIGH f/Vt**  
**LOW f/Vt**  
**SBT HIGH f**  
**SBT LOW f**  
**DISPLAY f/Vt**  
**EXIT**

Using the Spontaneous Breathing Trial option you can temporarily minimize ventilatory support and perform clinical assessments of a patient's dependence on, or ability to be removed from positive pressure ventilation. SBT mode should be used only while attended by a Respiratory Therapist or other properly trained and qualified personnel.



### **WARNING**

**Untrained Personnel** – Only properly trained personnel should operate the ventilator. The LTV<sup>®</sup> 1200 ventilator is a restricted medical device designed for use by Respiratory Therapists or other properly trained and qualified personnel under the direction of a physician and in accordance with applicable state laws and regulations.



### **AVERTISSEMENT**

**Personnel non qualifié** - Seul le personnel qualifié doit opérer le ventilateur. Le ventilateur de la 1200 LTV<sup>®</sup> est un dispositif médical restreint conçu pour être utilisé par les inhalothérapeutes ou autres personnes qualifiées, et par le personnel qualifié sous la supervision d'un médecin et en conformité avec les lois et règlements applicables.

## SBT Operations (cont.)

**When the Spontaneous Breathing Trial mode is turned on (SBT ON selected);**

- The ventilator switches to CPAP mode.
- Pressure Support and FIO<sub>2</sub> control settings on the front panel are overridden with the values preset in the SBT OP menus.
- The High Breath Rate alarm (**HIGH f**) in the ALARM OP menu is disabled (as long as the SBT mode is on).

**The Spontaneous Breathing Trial mode will be terminated and ventilation will return to the previously set modes/settings when;**

- The minutes preset in the **SBT OP, MINUTES** menu have elapsed.
- An SBT alarm (**SBT < f, SBT > f, SBT < f/Vt, or SBT > f/Vt**) has been active in excess of 5 minutes (see *Chapter 9 - Ventilator Alarms* for additional information).
- An Apnea alarm (**APNEA**) is generated and the ventilator automatically enters the Apnea Backup mode of ventilation (see *Chapter 9 - Ventilator Alarms* for additional information).
- A High Pressure alarm (**HIGH PRES**) is generated during which the ventilator's turbine is stopped to allow the circuit pressure to evacuate (see *Chapter 9 - Ventilator Alarms* for additional information).
- The operator selects **SBT OFF** in the SBT OP, SBT START menu.
- The operator pushes any control button, other than the **Manual Breath, Select, Control Lock or Silence Reset**.

**To modify the Spontaneous Breathing Trial settings:**

- 1) Turn the **Set Value** knob until **SBT START** is displayed, push the **Select** button, and **SBT OFF** or **SBT ON** is displayed.

Turn the **Set Value** knob until the desired setting is displayed, and push the **Select** button.

- When **SBT ON** is selected, the Spontaneous Breathing Trial ventilation mode is turned on using the current SBT menu settings. If the SBT menu settings were not previously reset, the factory set default settings will be used (see *DEFAULTS* in Chapter 9 - Ventilator Alarms for additional information). **All SBT menu settings are to be reviewed for applicability and/or set as necessary, prior to selecting the SBT ON menu option.**
  - When the Spontaneous Breathing Trial ventilation mode is active and **SBT OFF** is selected, the Spontaneous Breathing Trial ventilation mode is terminated and ventilation returns to the previously set modes/settings.
- 2) Turn the **Set Value** knob until **PRES SUPPORT** is displayed, push the **Select** button and **PEEP +xx cmH<sub>2</sub>O** is displayed.  
Turn the **Set Value** knob until the desired setting is displayed, push the **Select** button, and the SBT Pressure Support value is set.
    - **Range:** 0 - 30 cmH<sub>2</sub>O, in increments of 1
  - 3) Turn the **Set Value** knob until **PEEP** is displayed, push the **Select** button, and **xxx cmH<sub>2</sub>O** is displayed.  
Turn the **Set Value** knob until the desired setting is displayed, push the **Select** button, and the SBT PEEP value is set.
    - **Range:** 0 – 20 cmH<sub>2</sub>O, in increments of 1

### SBT Operations (cont.)

- 4) Turn the **Set Value** knob until **SBT FIO2** is displayed, push the **Select** button, and **xxx O2%** is displayed.  
Turn the **Set Value** knob until the desired setting is displayed, push the **Select** button, and the SBT O<sub>2</sub>% value is set.
  - **Range:** 21 - 100 %, in increments of 1
- 5) Turn the **Set Value** knob until **MINUTES** is displayed, push the **Select** button, and **xxx MIN** is displayed.  
Turn the **Set Value** knob until the desired setting is displayed, push the **Select** button, and the SBT ventilation mode run time is set.
  - **Range:** 15 - 120 minutes, in increments of 5
- 6) Turn the **Set Value** knob until **HIGH f/Vt** is displayed, push the **Select** button, and **xxx f/Vt** is displayed.  
Turn the **Set Value** knob until the desired setting is displayed, push the **Select** button, and the SBT high f/Vt alarm value is set (see *SBT > f/Vt* in Chapter 9 - Ventilator Alarms, for additional information).
  - **Range:** HI f/Vt OFF or 70 - 900 f/Vt, in increments of 5
- 7) Turn the **Set Value** knob until **LOW f/Vt** is displayed, push the **Select** button, and **xxx f/Vt** is displayed.  
Turn the **Set Value** knob until the desired setting is displayed, push the **Select** button, and the SBT low f/Vt alarm value is set (see *SBT < f/Vt* in Chapter 9 - Ventilator Alarms, for additional information).
  - **Range:** LO f/Vt OFF or 5 - 90 f/Vt, in increments of 5
- 8) Turn the **Set Value** knob until **SBT HIGH f** is displayed, push the **Select** button, and **xxx bpm** is displayed.  
Turn the **Set Value** knob until the desired setting is displayed, push the **Select** button, and the SBT high f alarm value is set (see *SBT > f* in Chapter 9 - Ventilator Alarms, for additional information).
  - **Range:** SBT HI f OFF or 15 - 80 bpm, in increments of 1
- 9) Turn the **Set Value** knob until **SBT LOW f** is displayed, push the **Select** button, and **xxx bpm** is displayed.  
Turn the **Set Value** knob until the desired setting is displayed, push the **Select** button, and the SBT low f alarm value is set (see *SBT < f* in Chapter 9 - Ventilator Alarms, additional information).
  - **Range:** SBT LO f OFF or 1 - 40 bpm, in increments of 1
- 10) Turn the **Set Value** knob until **DISPLAY f/Vt** is displayed, push the **Select** button, and **DISPLAY OFF** or **DISPLAY ON** is displayed.  
Turn the **Set Value** knob until the desired setting is displayed, push the **Select** button, and the SBT scrolling display status (on or off) of the monitored xxx f/Vt value is set (see *Automatic or Manual Data Display Scrolling* in Chapter 8 - Monitored Data, for additional information).

### Exit

**To return to the top of the SBT OP menu:**

- 1) Push the **Select** button while **EXIT** is displayed.

### SBT Alarms

---

For information concerning SBT related alarms, see *Chapter 9 - Ventilator Alarms*.

## *Transducer Autozero*

---

Use the Transducer Autozero menu to manually schedule transducer autozeros and to view previous autozero results. Autozeros are automatically scheduled at appropriate intervals during ventilator operation, so manual scheduling of autozeros is not commonly performed, but may occasionally be done.

The menu is set up as follows:

### **XDCR ZERO**

**AP xxxx P**

**FDb xxxx P**

**FDw xxxx P**

**FDn xxxx P**

## *Airway Pressure Transducer Autozero*

---

Use this item to view the Airway Pressure Transducer Autozero results and schedule the Airway Pressure Transducer Autozero to be run.

### **To view the Airway Pressure Transducer Autozero results:**

- 1) The previous results, **AP xxxx P**, are displayed. The final P indicates the previous zero results were within the required tolerance and the previous autozero passed. If a final F is displayed, the previous zero results were outside the required tolerance and the autozero failed. An asterisk indicates that an autozero is scheduled for the next breath.
- 2) Turn the **Set Value** knob to display the **EXIT** option.
- 3) Push the **Select** button.

### **To schedule the Airway Pressure Transducer Autozero:**

- 1) The previous results, **AP xxxx P**, are displayed.
- 2) Push the **Select** button. An asterisk appears, the pass / fail indicator is removed from the display and the test is scheduled for the next breath.
- 3) After the autozero is run on the next breath, the new autozero value and the pass / fail indicator are displayed.

If an autozero fails, it will be automatically rescheduled for the next breath.

## *Bi-directional Flow Transducer Differential Autozero*

---

Use this item to view the Bi-directional Flow Transducer Differential Autozero results and schedule Autozeros to be run.

### **To view the Bi-directional Flow Transducer Differential Autozero results:**

- 1) The previous results, **FDb xxxx P**, are displayed. If the results are displayed as **FDb xxxx -**, the Bi-directional Flow Transducer is not installed on your unit. The final P indicates the previous zero results were within the required tolerance and the previous autozero passed. If a final F is displayed, the previous zero results were outside the required tolerance and the autozero failed. An asterisk indicates that an autozero is scheduled for the next breath.
- 2) Turn the **Set Value** knob to display the **EXIT** option.
- 3) Push the **Select** button.

### **To schedule the Bi-directional Flow Transducer Differential Autozero:**

- 1) The previous results, **FDb xxxx P**, are displayed.
- 2) Push the **Select** button. An asterisk appears, the pass / fail indicator is removed from the display and the autozero test is scheduled for the next breath.
- 3) After the autozero is run on the next breath, the new autozero value and the pass / fail indicator are displayed.

If the autozero fails, it will be automatically rescheduled for the next breath.

## *Exhalation Flow Transducer Differential Autozero - Narrow*

---

Use this item to view the Exhalation Flow Transducer Differential Autozero – Narrow results and schedule the Exhalation Flow Transducer Differential Autozero - Narrow to be run.

### **To view the Exhalation Flow Transducer Differential Autozero – Narrow results:**

- 1) The previous results, **FDn xxxx P**, are displayed. The final **P** indicates the previous zero results were within the required tolerance and the previous autozero passed. If a final **F** is displayed, the previous zero results were outside the required tolerance and the autozero failed. An asterisk indicates that an autozero is scheduled for the next breath.
- 2) Turn the **Set Value** knob to display the **EXIT** option.
- 3) Push the **Select** button.

### **To schedule the Exhalation Flow Transducer Differential Autozero - Narrow:**

- 1) The previous results, **FDn xxxx P**, are displayed.
- 2) Push the **Select** button. An asterisk appears, the pass / fail indicator is removed from the display and the autozero test is scheduled for the next breath.
- 3) After the autozero is run on the next breath, the new autozero value and the pass / fail indicator are displayed.

If the autozero fails, it will be automatically rescheduled for the next breath.

## *Exhalation Flow Transducer Differential Autozero - Wide*

---

Use this item to view the Exhalation Flow Transducer Differential Autozero - Wide results and schedule the Exhalation Flow Transducer Differential Autozeros - Wide to be run.

### **To view the Exhalation Flow Transducer Differential Autozero – Wide results:**

- 1) The previous results, **FDw xxxx P**, are displayed. The final **P** indicates the previous zero results were within the required tolerance and the previous autozero passed. If a final **F** is displayed, the previous zero results were outside the required tolerance and the autozero failed. An asterisk indicates that an autozero is scheduled for the next breath.
- 2) Turn the **Set Value** knob to display the **EXIT** option.
- 3) Push the **Select** button.

### **To schedule the Exhalation Flow Transducer Differential Autozero - Wide:**

- 1) The previous results, **FDw xxxx P**, are displayed.
- 2) Push the **Select** button. An asterisk appears, the pass / fail indicator is removed from the display and the autozero test is scheduled for the next breath.
- 3) After the autozero is run on the next breath, the new autozero value and the pass / fail indicator are displayed.

If the autozero fails, it will be automatically rescheduled for the next breath.

## Real Time Transducers

---

Use the Real Time Transducer data to view the real time activity in the ventilator. The real time transducer menu is set up as follows:

### RT XDCR DATA

**AP** xx.xx  $\text{cmH}_2\text{O}$   
**FDb** xx.xx  $\text{cmH}_2\text{O}$   
**FDw** xx.xx  $\text{cmH}_2\text{O}$   
**FDn** xx.xx  $\text{cmH}_2\text{O}$   
**FTw or FTn** xx.xx Lpm  
**FTb** x.xx Lpm  
**LEAK** xx.xx Lpm  
**FVd** xx.xx  $\text{cmH}_2\text{O}$   
**FV** xx.xx Lpm  
**STEP** xxxx  
**TS** xxxx rpm  
**O2** xx.xx PSI  
**BV** xx.xx VOLTS  
**EV** xx.xx VOLTS  
**PPP** xx.xx  $\text{cmH}_2\text{O}$   
**RT EXIT**

Each item displays real time activity in the displayed units. For some items, transducer counts can also be displayed. Pushing **Select** while the item is displayed displays additional transducer data<sup>49</sup>.

Display	Real Time Data
<b>AP</b> xx.xx $\text{cmH}_2\text{O}$	Airway pressure as measured at the patient wye using the high side proximal sense line.
<b>FDb</b> xx.xx $\text{cmH}_2\text{O}$	Flow differential pressure as measured at the patient wye using the bi-directional transducer. Differential pressure is measured between the high and low side proximal sense lines.
<b>FDw</b> xx.xx $\text{cmH}_2\text{O}$	Flow differential pressure as measured at the patient wye using the wide scale transducer. Differential pressure is measured between the high and low side proximal sense lines.
<b>FDn</b> xx.xx $\text{cmH}_2\text{O}$	Flow differential pressure as measured at the patient wye using the narrow scale transducer. Differential pressure is measured between the high and low side proximal sense lines. The narrow scale transducer is only used for differential pressures between -0.35 $\text{cmH}_2\text{O}$ and 0.35 $\text{cmH}_2\text{O}$ (approximately -15 Lpm to 15 Lpm).
<b>FTb</b> xx.xx Lpm	Flow in Lpm calculated from the differential pressure measured at the patient wye using the bi-directional transducer. Transducer count display is not available for this item.

<sup>49</sup> For more information, see the LTV<sup>®</sup> Series Ventilator's Service Manual, p/n 10665.



<b>Display</b>	<b>Real Time Data</b>
<b>LEAK xx.xx Lpm</b>	Leak flow calculated from the differential pressure transducer, measured at the patient wye during exhalation. This value will be approximately 0.0 when the ventilator is autocycling. Eliminate autocycling by turning the sensitivity off before reviewing this measurement.
<b>FTw xx.xx Lpm</b> or <b>FTn xx.xx Lpm</b>	Flow in Lpm calculated from the differential pressure measured at the patient wye. When the value is calculated using the wide scale differential pressure, <b>FTw</b> is displayed. When the value is calculated using the narrow scale differential pressure, <b>FTn</b> is displayed. When Leak Compensation is on, <b>FTw xx.xx</b> and <b>FTn xx.xx</b> Lpm values are offset by the value of <b>LEAK xx.xx</b> Lpm. Transducer count display is not available for this item.
<b>FVd xx.xx <sup>c</sup><sub>m</sub>H<sub>2</sub>O</b>	Differential pressure as measured across the flow valve.
<b>FV xx.xx Lpm</b>	Flow valve flow in Lpm calculated from the differential pressure measured across the flow valve. Transducer count display is not available for this item.
<b>STEP xxxx</b>	Commanded flow valve motor step position. Transducer count display is not available for this item.
<b>TS xxxx rpm</b>	The monitored speed of the turbine in rpms.
<b>O2 xx.xx PSI</b>	Oxygen inlet pressure in PSIG as measured at the inlet pressure transducer.
<b>BV xx.xx VOLTS</b>	Internal battery voltage.
<b>EV xx.xx VOLTS</b>	External power voltage.
<b>PPP xx.xx <sup>c</sup><sub>m</sub>H<sub>2</sub>O</b>	Pressure in the PEEP accumulator (PEEP Pilot Pressure)

## Chapter 11 - VENTILATOR CHECKOUT TESTS

This chapter details five test procedures accessed through the Vent Check menu and used to verify the proper operation of the LTV<sup>®</sup> 1200. These tests should be performed as shown in the schedule in *Appendix B - Set Up / Maintenance* for periodic maintenance and testing of the ventilator.

The five test procedures are:

Test	Test used to:
Alarm Test	Verify that the audible alarm is working correctly.
Display Test	Verify that the ventilator displays are working correctly.
Control Test	Verify that the buttons and the Set Value knob are working correctly.
Leak Test	Test the patient circuit for leaks.
Vent Inop Alarm Test	Verify that the Vent Inop alarm is working correctly.

The Vent Check Menu is set up as follows:

### VENT CHECK

- ALARM
- DISPLAY
- CONTROL
- LEAK
- EXIT

### WARNING

**Ventilator Checkout Tests** – Gas is not delivered to the patient during these tests. Disconnect the patient from the ventilator and ventilate using an alternative method before running the Ventilator Checkout tests.

**Leak Testing the Patient Breathing Circuit** – The patient circuit must be leak tested in **VENT CHECK** mode before connection to the patient. Ventilator Checkout mode should also be used to check for correct operation of the alarms, displays and controls. Harm to the patient or ineffective ventilation may result from failure to leak test the patient breathing circuit before connection to a patient. When using a heated humidifier, include it in the circuit when leak testing.

### AVERTISSEMENT

**Tests de vérification du ventilateur** – Noter que le gaz n'est pas transmis au patient au cours de ces tests. Débrancher le patient du ventilateur et ventiler à l'aide d'une forme de ventilation alternative avant de procéder aux tests de vérification du ventilateur.

**Contrôle de l'étanchéité du circuit respiratoire du patient** – L'étanchéité du circuit respiratoire du patient (vérification de ventilation) doit être vérifiée en mode **VENT CHECK** avant le raccordement au patient. En outre, on doit utiliser le mode Ventilator Checkout (vérification du ventilateur) afin de s'assurer du fonctionnement adéquat de l'alarme, des affichages et des commandes du ventilateur. Le défaut de vérifier l'étanchéité du circuit respiratoire du patient avant le raccordement à un patient peut être nocif pour le patient ou provoquer une ventilation inefficace. Lorsqu'un humidificateur chauffant est employé, il convient de l'inclure dans le circuit en procédant à la vérification de l'étanchéité.

**To enable the Ventilator Checkout menu:**

- 1) Disconnect the patient from the ventilator and ventilate the patient using an alternative method.
- 2) Turn the ventilator off.
- 3) Ensure that the AC Adapter is connected to a valid AC power source and verify that the **External Power** and **Charge Status** LEDs are illuminated.
- 4) Push and hold the **Select** button. Continue to hold the **Select** button and press the **On/Standby** button. **REMOVE PTNT** should be displayed; if not, power down the ventilator and repeat steps 2 through 4.
- 5) An audible alarm (alternating on/off tone) will sound while **REMOVE PTNT** is displayed.

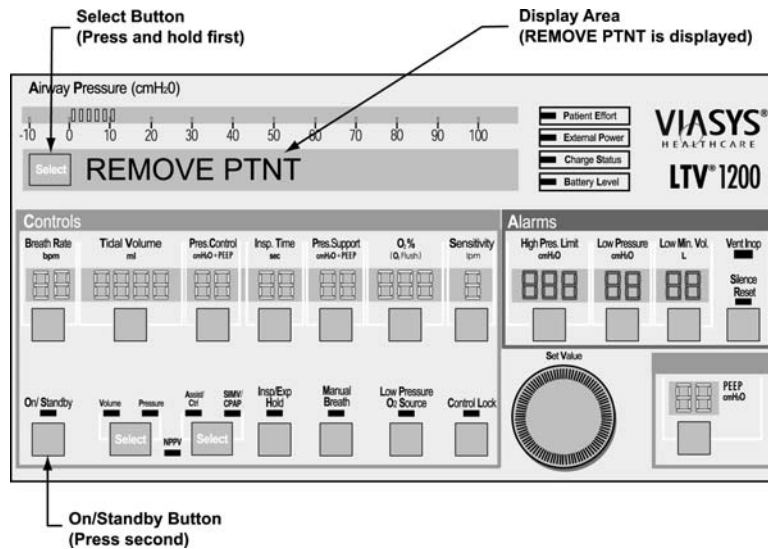

- 6) Clear the alarm by pressing the **Silence Reset** button. The audible alarm silences, and the display changes to **VENT CHECK**.

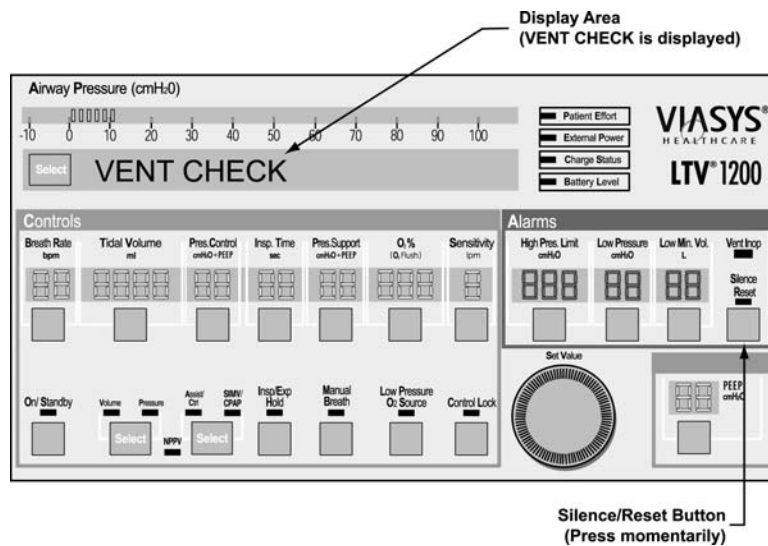

- 7) Push the **Select** button. The first Ventilator Checkout Test, **ALARM**, is displayed.

## Alarm Test

---

Use the Alarm Test to verify that the audible alarm is working correctly.

### To run the Alarm Test:

- 1) Push the **Select** button while **ALARM** is displayed.
- 2) Verify that the audible alarm is sounded.
  - If a Patient Assist Call System or Remote Alarm is connected via the ventilator's Patient Assist Port, verify the device also activates (audible/visual), as specified by its manufacturer.
- 3) When the alarm has sounded for at least 2 seconds, push the **Select** button again.
  - The audible alarm is silenced and the next menu item is displayed.
- 4) Verify a confirming audible chirp occurs after the alarm is silenced.

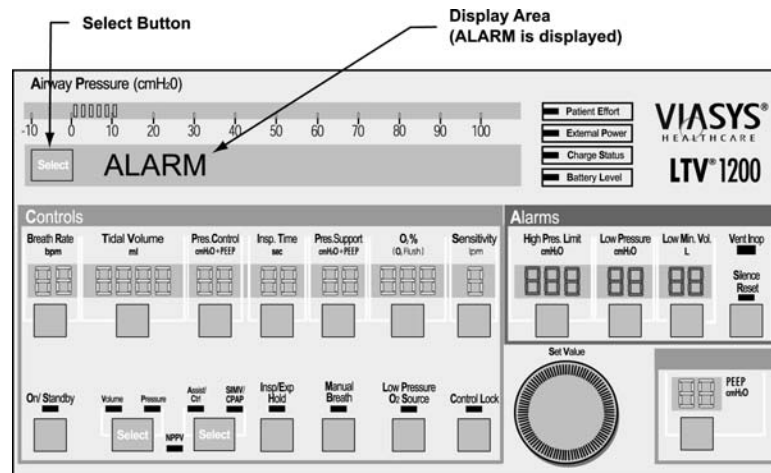

If the Alarm Test fails, see *Chapter 15 - Troubleshooting* for more information.

## Display Test

Use the Display Test to verify that the ventilator displays are working correctly.

### To run the Display Test:

- 1) Push the **Select** button while **DISPLAY** is displayed.
- 2) All segments of the 7-segment control displays, all dots of the dot-matrix window displays and all LEDs are illuminated.

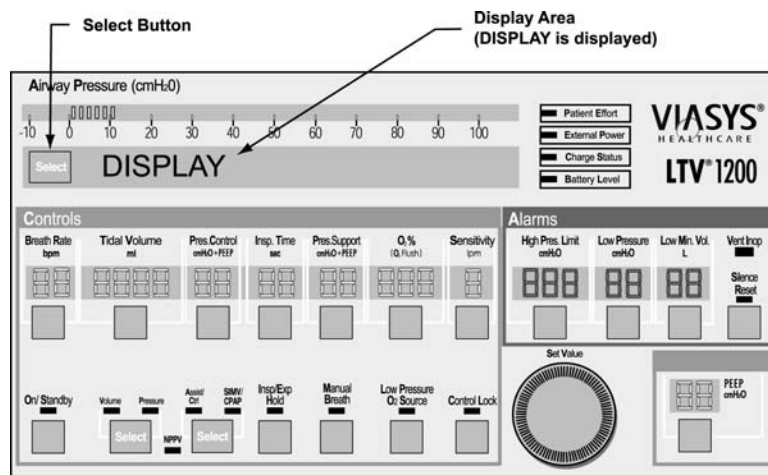

## NOTE

The display states for the **External Power**, **Vent Inop**, and **Charge Status** LEDs are not tested in the Display Test.

- The **External Power** and **Charge Status** LEDs are tested and verified when the AC adapter is connected to the ventilator (see page 11-2).
- The **Vent Inop** LED is tested and verified during the Vent Inop Alarm Test (see page 11-11).

## REMARQUE

Ce test d'affichage ne comprend pas l'état d'affichage des DEL **External Power**, **Vent Inop**, et **Charge Status**.

- Les DEL **External Power** et **Charge Status** sont testés et vérifiés lorsqu'on branche l'adaptateur CA au ventilateur (voir page 11-2).
- Le DEL **Vent Inop** est testé et vérifié en même temps que l'avertisseur du Vent Inop (voir page 11-11).

Display Test (cont)

Verify displays are illuminated in the following colors:

Display	Color	Display	Color
Airway Pressure Display	Green	Assist/Control Mode LED	Green
Display Window	Red	SIMV/CPAP Mode LED	Green
Breath Rate	Green	NPPV Mode LED	Green
Tidal Volume	Green	Inspiratory / Expiratory	Green
Pressure Control	Green	Manual Breath LED	Green
Inspiratory Time	Green	Low Pressure O <sub>2</sub> Source LED	Green
Pressure Support	Green	Control Lock LED	Green
O <sub>2</sub> % (O <sub>2</sub> Flush)	Green	PEEP	Green
Sensitivity	Green	Patient Effort LED	Green
High Pressure Limit Alarm	Red	External Power LED	Not tested
Low Pressure Alarm	Red	Charge Status LED	Not tested
Low Minute Volume Alarm	Red	Battery Level LED	Amber
On/Standby LED	Green	Vent Inop LED	Not tested
Volume Mode LED	Green	Silence Reset LED	Red
Pressure Mode LED	Green		

3) To end the display test, push the **Select** button again and the next menu item is displayed.

If the Display Test fails, see *Chapter 15 - Troubleshooting* for more information.

## Control Test

Use the Control Test to verify that the ventilator buttons and the **Set Value** knob are working correctly.

### To run the Control Test:

- 1) Push the **Select** button while **CONTROL** is displayed.

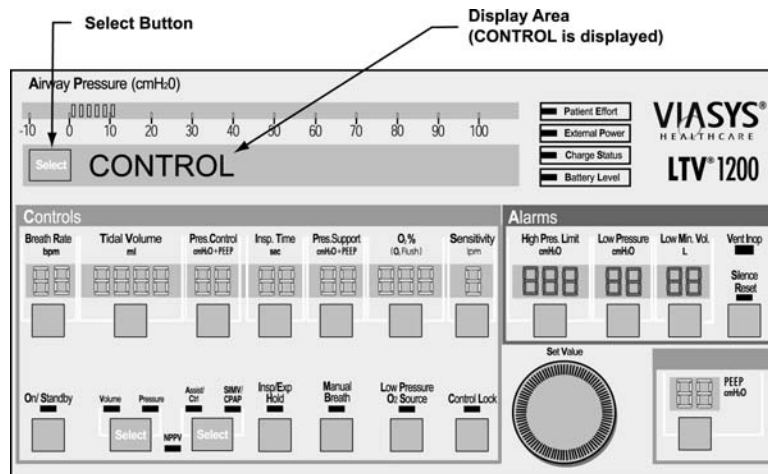

- 2) **SELECT** is displayed in the display window.

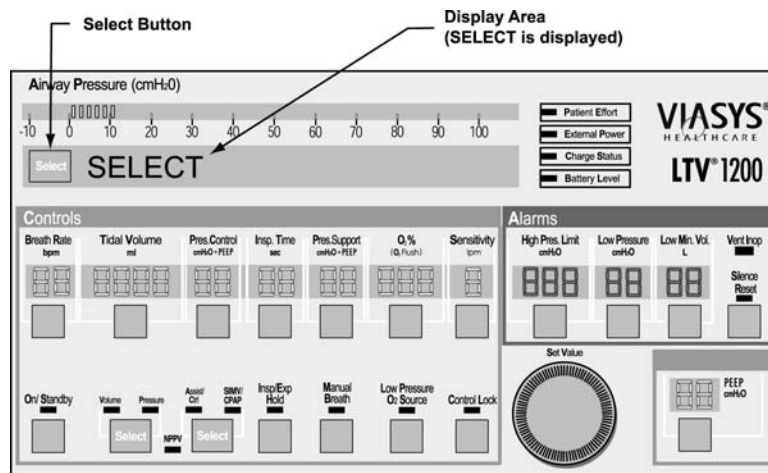

### Control Test (cont)

- 3) Test each control by pressing each button, one at a time. When pressed, verify that the name of the button pressed is displayed in the display window. Control names are as shown in the table below.

<b>Control</b>	<b>Display</b>
Display Select	<b>SELECT</b>
Breath Rate	<b>BREATH RATE</b>
Tidal Volume	<b>TIDAL VOLUME</b>
Pressure Control	<b>PRES CONTROL</b>
Inspiratory Time	<b>INSP TIME</b>
Pressure Support	<b>PRES SUPPORT</b>
O <sub>2</sub> % (O <sub>2</sub> Flush)	<b>O2%</b>
Sensitivity	<b>SENSITIVITY</b>
High Pressure Alarm	<b>HIGH PRES</b>
Low Peak Pressure	<b>LOW PRES</b>
Low Minute Volume	<b>LOW MIN VOL</b>
Silence Reset	<b>SILENCE</b>
On/Standby	<b>ON / STNDBY</b>
Volume & Pressure	<b>MODE VOL/PRS</b>
Assist/Control & SIMV/CPAP	<b>MODE A/C S/C</b>
Inspiratory / Expiratory Hold	<b>IE HOLD</b>
Manual Breath	<b>MANUAL BRTH</b>
Low Pressure O <sub>2</sub> Source	<b>LOW PRES O2</b>
Control Lock	<b>CONTROL LOCK</b>
Set Value knob rotate Left	<b>ROTATE LEFT</b>
Set Value knob rotate Right	<b>ROTATE RIGHT</b>
PEEP	<b>PEEP</b>

- 4) Test the **Set Value** knob by turning it clockwise and counterclockwise. Verify that the direction of rotation is displayed in the display window.
- 5) To exit the control test, push the **Select** button again and the next menu item is displayed.

If the Control Test fails, see *Chapter 15 - Troubleshooting* for more information.



## Leak Test

Use the Leak Test to test the patient circuit for leaks.

### To run the Leak Test:

- 1) Attach all patient circuit accessories (such as water traps, heated circuits and humidifiers) to the patient circuit.
- 2) Connect the patient circuit to the ventilator.
- 3) With a clean, gloved hand or 4"X4" gauze pad, occlude the proximal end of the patient circuit..

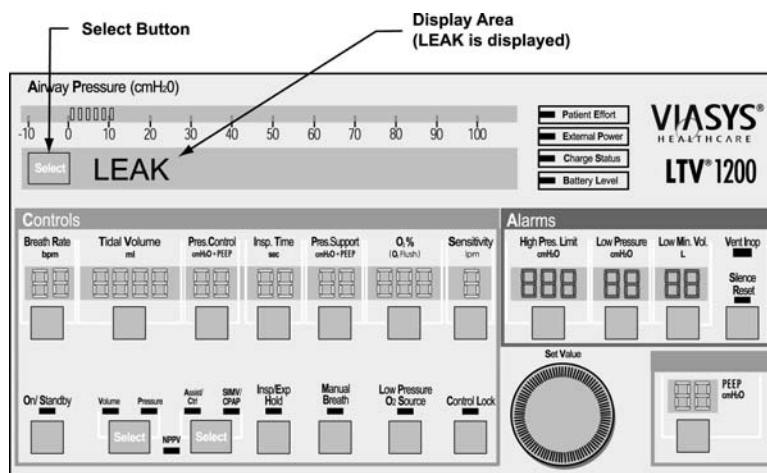

- 4) Push the **Select** button while **LEAK** is displayed.

### NOTE

The Leak Test cannot be run until the ventilator has been running for 60 seconds. If you attempt to run the leak test before the warm-up period has completed, a **WAITING** message will be displayed. When the warm-up period is complete, the Leak Test menu item is redisplayed.

### REMARQUE

Le test de fuites ne peut s'exécuter tant que le ventilateur n'a pas fonctionné durant 60 secondes. Si vous tentez d'exécuter un test de fuites avant que la période de réchauffement ne soit complétée, un message «**PATIENTEZ** » sera affiché. Lorsque la période de réchauffement est complétée, les éléments du menu Test de fuites sont de nouveau affichés.

### Leak Test (cont)

- 5) To perform the Leak Test, the ventilator does the following:
  - a) Closes the exhalation valve and sets the flow valve to a near-closed state. The display briefly shows **HOMING VALVE**.
  - b) Elevates the turbine motor speed. The display shows **SET TURBINE**. If the display shows **LEAK xx.x FAIL**, see *Chapter 15 - Troubleshooting* for more information.
  - c) Elevates the circuit pressure. The display shows **PRES xx.x cmH<sub>2</sub>O** where **xx.x** is the real-time airway pressure.
  - d) Sets the flow valve to a near closed position. The display shows **FLOW xx.x Lpm** where **xx.x** is the flow through the flow valve.
  - e) After several seconds, the display shows **LEAK xx.x PASS** or **LEAK xx.x FAIL** indicating the Leak Test results. The Leak Test will fail if the flow through the flow valve is greater than 1 Lpm.
- 6) To exit the Leak Test, push the **Select** button again and the next menu item is displayed.

If the ventilator fails the Leak Test, see *Chapter 15 - Troubleshooting* for more information.

## Vent Inop Alarm Test

Use the Vent Inop Alarm Test to verify that the Vent Inop alarm is working correctly.

### To run the Vent Inop Alarm Test:

- 1) To run the Vent Inop Alarm Test, the ventilator must be on (running) for at least 60 seconds and the Ventilator Checkout menu must be enabled.
  - When the Ventilator Checkout menu is enabled, **VENT CHECK**, **ALARM**, **DISPLAY**, **CONTROL**, **LEAK**, or **EXIT** is displayed in the ventilator display area.
- 2) Turn the ventilator off by pressing and holding the **On/Standby** button for a minimum of 3 seconds. **DO NOT** push the **Silence Reset** button.

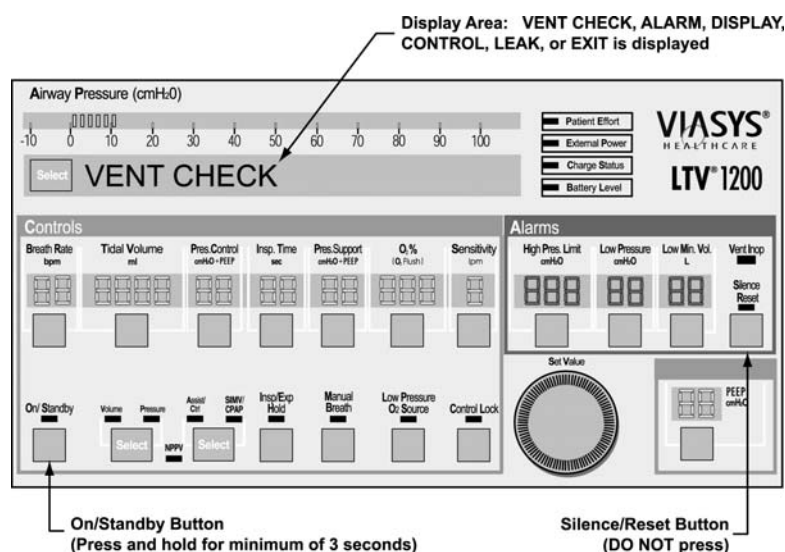

- 3) Observe the ventilator for 15 seconds.
  - Listen for the alarm tone
  - Watch the **Vent Inop** LED

## Vent Inop Alarm Test (cont)

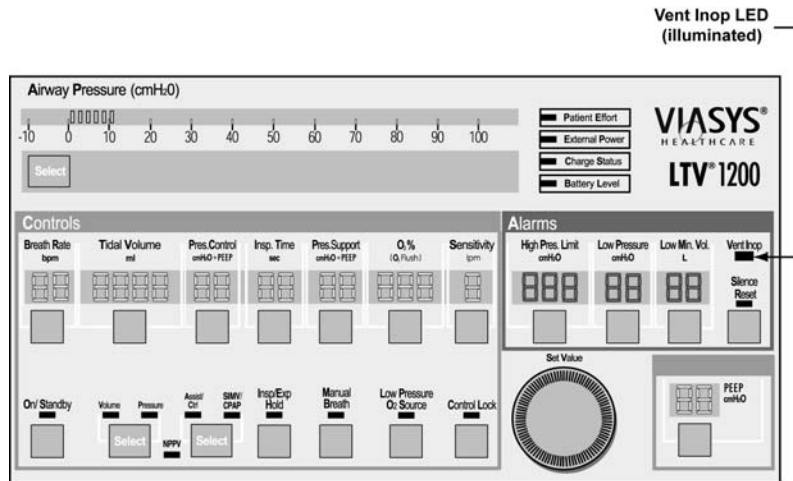

- 4) For all ventilators, verify that both of the following conditions existed;
  - The alarm tone sounded continuously for the full 15-second duration.
  - The **Vent Inop** LED illuminated continuously for the full 15-second duration.
- 5) If a Patient Assist Call System or Remote Alarm is connected via the ventilator's Patient Assist Port, verify the device also activates (audible/visual), as specified by its manufacturer.
- 6) Silence the alarm by pressing the **Silence Reset** button.
- 7) Verify the following;
  - A confirming audible chirp occurred after the alarm was silenced.

If the Inop Alarm fails the test, discontinue use of the ventilator and immediately contact a certified Pulmonetic Systems' service technician.

## Exit

To exit the vent check mode and return to normal ventilation mode at any point proceed as follows:

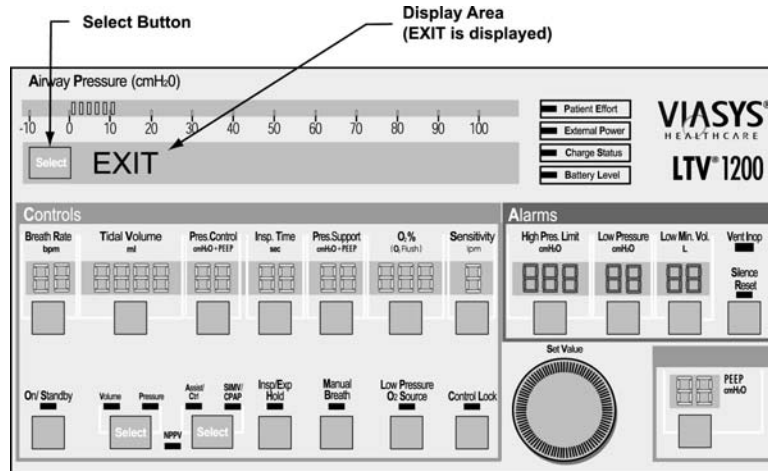

### Enter normal ventilation mode:

- 1) Turn the **Set Value** knob to scroll through the main menu entries (**VENT OPS**, **ALARM OPS**, **VENT CHECK**, etc.) until **EXIT** is displayed.
- 2) Push the **Select** button while **EXIT** is displayed.
- 3) Alternatively, push the **Control Lock** button until normal ventilation mode is restored.

POST will be performed and the ventilator will begin ventilation using the previously stored settings.

## Chapter 12 - OPERATING PROCEDURE

This section describes how to turn the LTV<sup>®</sup> 1200 ventilator on and off, and how to set up the ventilation modes.

### *To Turn the Ventilator On*

- 1) Connect the unit to an external source of power. The AC power adapter may be used or the ventilator may be connected to an external battery.
  - The **External Power** LED is lit to indicate the external power source voltage level.
  - The ventilator begins charging the internal battery from the external source.
  - The **Charge Status** LED is lit to indicate the charge progress.

### **NOTE**

In the absence of an external power source, the ventilator automatically begins operation using the internal battery.

Do not operate the LTV<sup>®</sup> 1200 exclusively on the internal battery as a standard operating practice. The internal battery should be used for **emergency situations only** or for short periods while switching between external power supply connections.

### **REMARQUE**

S'il n'y a pas de source d'alimentation externe, le ventilateur s'alimente automatiquement de la pile interne.

Ne pas utiliser le LTV<sup>®</sup> 1200 exclusivement avec la batterie interne en tant que procédure d'exploitation normale. La batterie interne doit être réservée aux **situations d'urgence seulement** ou pour de courtes périodes de temps pendant le transfert entre des sources d'alimentation externes.

- 2) Push the **On/Standby** button and the ventilator will commence operation:
  - The **On/Standby** LED is lit.
  - The Power On Self Tests<sup>50</sup> (POST) are performed:
    - The front panel displays light up.
    - The audible alarm activates for 1 second (to be verified by operator).
    - A confirming audible chirp sounds (to be verified by operator).
    - POST messages (**CPU**, **SRAM**, **INT VECTOR**, **ROM CRC** and **EEPROM**) are flashed in the message window.

<sup>50</sup> Power On Self Tests - A set of self-tests the ventilator performs when turned on to verify the operational integrity of the Processor, Displays, Audible Alarm, Confirming Audible Chirp, SRAM, Program Memory and EEPROM (some tests require operator visual and/or audible verification).

## To Turn the Ventilator On (cont.)

### **If the Power On Self Tests are passed successfully;**

The ventilator starts operation using the stored control settings, with the following exceptions:

If the Patient Query feature is enabled/on when the ventilator is powered up, ventilation and alarm activation are suspended and the message **SAME PATIENT** is displayed (see *Presets* in Chapter 10 - Extended Features).

- To enable the suspended alarms and begin ventilation with the settings in use during the last power cycle, press the **Select** button while **SAME PATIENT** is displayed

OR

- To enable the suspended alarms and begin ventilation with Presets values appropriate for a new patient, turn the **Set Value** knob until **NEW PATIENT** is displayed and press the **Select** button. Then turn the **Set Value** knob until the desired patient type is displayed (**INFANT**, **PEDIATRIC** or **ADULT**) and press the **Select** button (see *LTV® 1200 Presets Table* in Chapter 10 – Extended Features for detailed settings information)
  - Turning the **Set Value** knob until **EXIT** is displayed and pressing the **Select** button returns the ventilator to the **SAME PATIENT** menu option/message

If no controls are activated for three (3) seconds while either the **SAME PATIENT** or **NEW PATIENT** options are being displayed, an audible alert sounds. Activation of any control resets the 3 second delay of the audible alert.

If the Patient Query feature is disabled/off when the ventilator is powered up and passes POST, it will begin ventilation (appropriate alarms enabled) using the settings in use during the last power cycle.

To prevent autocycling, the Leak Compensation feature (if enabled/on) is suspended during the first 30 seconds of operation.

To prevent nuisance alarms, the **LOW MIN VOL** alarm (Low Minute Volume) is suspended for the first 20 seconds and the **HIGH f** alarm (High Breath Rate) is suspended for the first 60 seconds of operation.

### **If the Power On Self Tests fail;**

The mode of failure (**CPU**, **SRAM**, **INT VECTOR**, **ROM CRC** or **EEPROM**) is displayed in the message window and an audible alarm sounds continuously.

- Turn the ventilator off by pushing the **On/Standby** button
- Silence the alarm by pushing the **Silence Reset** button
- Discontinue use of the ventilator and immediately contact a certified Pulmonetic Systems' service technician or Pulmonetic Systems, Inc

## Before Connecting the Ventilator to a Patient

---

Perform the following steps before connecting the ventilator to a patient:

- 1) If this is the initial use of the ventilator, follow the checkout procedures in *Appendix C - Installation and Checkout* before proceeding.
- 2) If desired, you may connect the ventilator to a **Patient Assist Call system**. See *Appendix C - Installation and Checkout* for details.

- 3) If required, connect a low or high pressure **oxygen source** to the ventilator. If you connect a low pressure oxygen source, make sure to select the **Low Pressure O<sub>2</sub> Source** option on the front panel. See *Appendix C - Installation and Checkout* for connection and setup details.

## **WARNING**

**Inspired Oxygen (FIO<sub>2</sub>) Concentration** – If the patient has a variable respiratory rate, his/her minute ventilation will fluctuate. If exact concentrations of inspired oxygen (FIO<sub>2</sub>) are required to be delivered to the patient, it is recommended that an accurate oxygen analyzer with alarms be used.

## **AVERTISSEMENT**

**Concentration d'oxygène inspiré (FIO<sub>2</sub>)** – Si la fréquence respiratoire du patient est variable, sa ventilation-minute va fluctuer. Lorsqu'une concentration exacte d'oxygène inspiré (FIO<sub>2</sub>) est nécessaire pour une transmission au patient, il est recommandé d'utiliser un analyseur de niveau d'oxygène précis, comportant des alarmes.

- 4) Connect the **Patient Circuit**.<sup>51</sup> To keep moisture out of the sense lines attached at the patient wye, be sure to connect the exhalation valve and circuit to the wye so the proximal sense lines are oriented up (see below). Connect a test lung to the circuit.

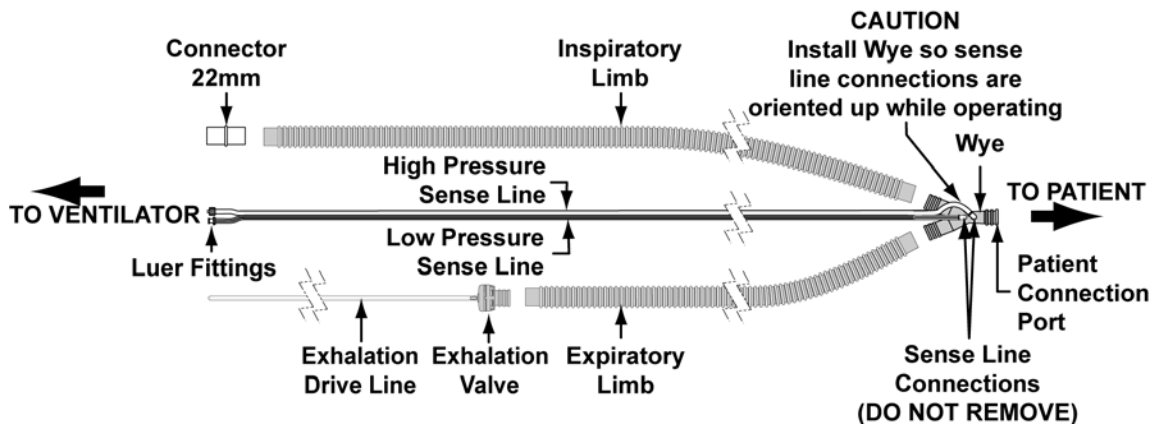

- 5) Set any desired extended features options. For a detailed list of extended features see *Chapter 10 - Extended Features*.
- 6) Select the ventilation mode and all controls, including PEEP, to prescribed values. Detailed procedures for setting each mode are included later in this chapter.

<sup>51</sup> The LTV® Patient Circuit complies with ASTM Specification F 1246.



## Procedure for Control Mode Set Up

### Set any desired Extended Features options and:

- 1) Push the mode **Select** button twice to toggle the modes between **Assist/ Ctrl** and **SIMV/CPAP**. Select the **Assist/ Ctrl** mode.
- 2) Push the mode **Select** button twice to toggle between **Volume** and **Pressure** ventilation. Select **Volume** or **Pressure**, as desired.
- 3) Establish the **Breath Rate**.
- 4) If **Volume** ventilation is selected, establish the **Tidal Volume**. The calculated peak flow **Vcalc** is displayed in the window while Tidal Volume is being changed.
- 5) If **Pressure** ventilation is selected, establish the **Pressure Control**.
- 6) Establish the **Inspiratory Time**. The calculated peak flow **Vcalc** is displayed in the window while Inspiratory Time is being changed. **Vcalc** only applies to volume ventilation.
- 7) Set the desired percentage of oxygen to be delivered by the ventilator.
- 8) Set the **Sensitivity** to dashes “-”.
- 9) Set the **High Pres. Limit** alarm.
- 10) Set the **Low Pressure** alarm.
- 11) Set the **Low Min. Vol.** alarm.
- 12) Adjust the **PEEP**.

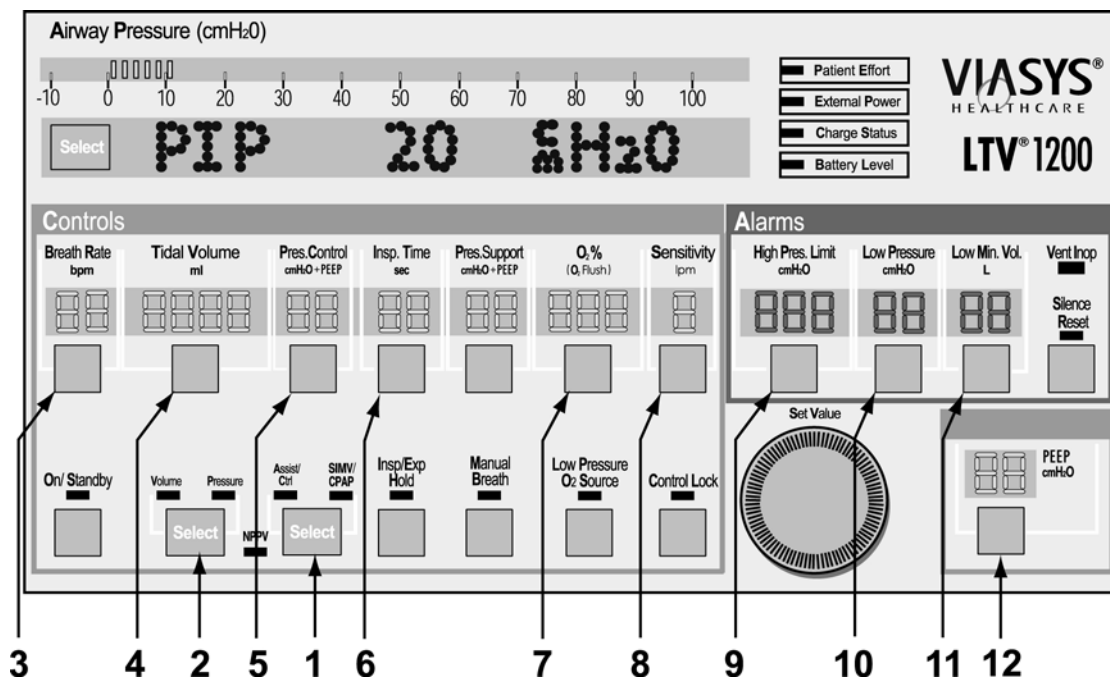

## Procedure for Assist/Control Mode Set Up

### Set any desired Extended Features options and:

- 1) Push the mode **Select** button twice to toggle the modes between **Assist/ Ctrl** and **SIMV/CPAP**. Select the **Assist/ Ctrl** mode.
- 2) Push the mode **Select** button twice to toggle between **Volume** and **Pressure** ventilation. Select **Volume** or **Pressure**, as desired.
- 3) Establish the **Breath Rate**.
- 4) If **Volume** ventilation is selected, establish the **Tidal Volume**. The calculated peak flow **Vcalc** is displayed in the window while Tidal Volume is being changed.
- 5) If **Pressure** ventilation is selected, establish the **Pressure Control**.
- 6) Establish the **Inspiratory Time**. The calculated peak flow **Vcalc** is displayed in the window while Inspiratory Time is being changed. **Vcalc** only applies to volume ventilation.
- 7) Set the desired percentage of oxygen to be delivered by the ventilator.
- 8) Set the **Sensitivity** to a setting from 1 to 9.
- 9) Set the **High Pres. Limit** alarm.
- 10) Set the **Low Pressure** alarm.
- 11) Set the **Low Min. Vol.** alarm.
- 12) Adjust the **PEEP**.

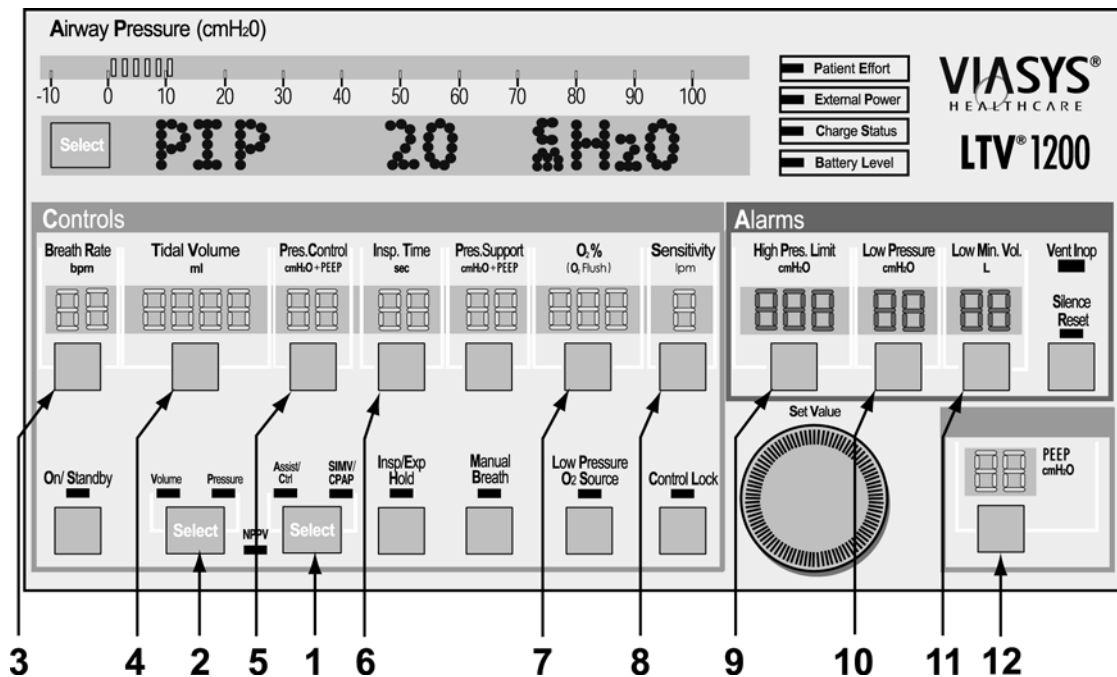

## Procedure for SIMV Mode Set Up

### Set any desired Extended Features options and:

- 1) Push the mode **Select** button twice to toggle the modes between **Assist/ Ctrl** and **SIMV/CPAP**. Select the **SIMV/CPAP** mode.
- 2) Push the mode **Select** button twice to toggle between **Volume** and **Pressure** ventilation. Select **Volume** or **Pressure**, as desired.
- 3) Establish the **Breath Rate**.
- 4) If **Volume** ventilation is selected, establish the **Tidal Volume**. The calculated peak flow **Vcalc** is displayed in the window while Tidal Volume is being changed.
- 5) If **Pressure** ventilation is selected, establish the **Pressure Control**.
- 6) Establish the **Inspiratory Time**. The calculated peak flow **Vcalc** is displayed in the window while Inspiratory Time is being changed. **Vcalc** only applies to volume ventilation.
- 7) Set the **Pressure Support**, if desired.
- 8) Set the desired percentage of oxygen to be delivered by the ventilator.
- 9) Set the **Sensitivity** to a setting from 1 to 9.
- 10) Set the **High Pres. Limit** alarm.
- 11) Set the **Low Pressure** alarm.
- 12) Set the **Low Min. Vol.** alarm.
- 13) Adjust the **PEEP**.

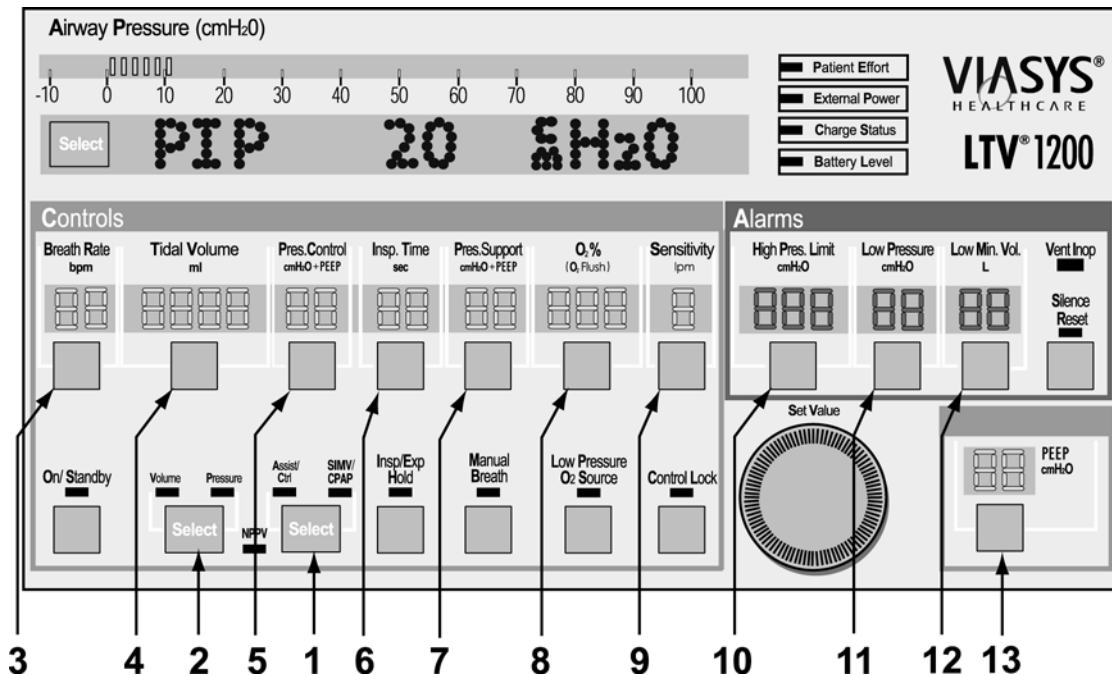

## Procedure for CPAP Mode Set Up

### Set any desired Extended Features options and:

- 1) Push the mode **Select** button twice to toggle the modes between **Assist/ Ctrl** and **SIMV/CPAP**. Select the **SIMV/CPAP** mode.
- 2) Push the mode **Select** button twice to toggle between **Volume** and **Pressure** ventilation for apnea backup. Select **Volume** or **Pressure**, as ordered.
- 3) Establish the **Breath Rate** to dashes "--".
- 4) If **Volume** ventilation is selected, establish the **Tidal Volume** for apnea backup. The calculated peak flow **Vcalc** is displayed in the window while Tidal Volume is being changed.
- 5) If **Pressure** ventilation is selected, establish the **Pressure Control** for apnea backup.
- 6) Establish the **Inspiratory Time** for apnea backup. The calculated peak flow **Vcalc** is displayed in the window while Inspiratory Time is being changed. **Vcalc** only applies to volume ventilation.
- 7) Set the **Pressure Support**, if desired.
- 8) Set the desired percentage of oxygen to be delivered by the ventilator.
- 9) Set the **Sensitivity** to a setting from 1 to 9.
- 10) Set the **High Pres. Limit** alarm.
- 11) Set the **Low Pressure** alarm for apnea backup.
- 12) Set the **Low Min. Vol.** alarm.
- 13) Adjust the **PEEP**.

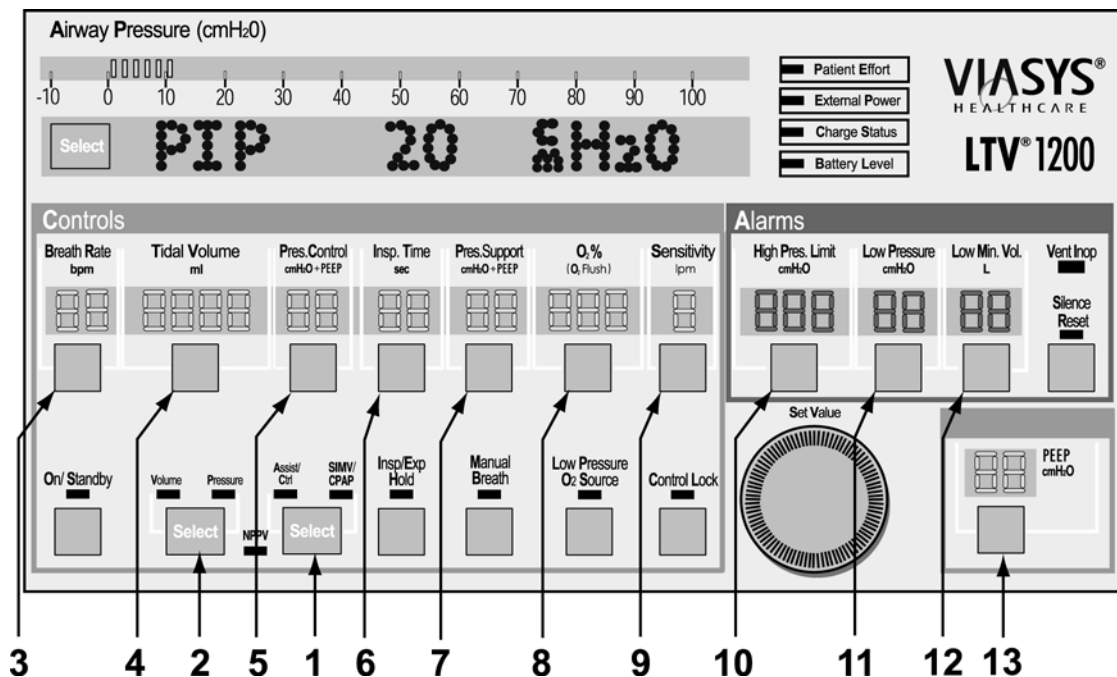

## Procedure for NPPV Mode Set Up

### Set any desired Extended Features options and:

- 1) Push the **Assist/Control, SIMV/CPAP** mode button until the **NPPV** LED flashes. Press the button once more to confirm. The **NPPV** LED continues to flash and **SET IPAP** displays. The **Pres. Support** control display is bright and all other controls dim.
- 2) Turn the **Set Value** knob to adjust the IPAP value (shown in the **Pres. Support** LED window). Press the **Pres. Support** button to confirm, **SET EPAP** will display. The **PEEP** control display is bright and all other controls are dim.
- 3) Turn the **Set Value** knob to adjust the EPAP value (shown in the **PEEP** LED window). Press the **PEEP** button to confirm.
- 4) The **PEEP** button push confirms NPPV operation and LED then turns solid.
- 5) Set the desired percentage of oxygen to be delivered by the ventilator.
- 6) Set the **High Pres. Limit** alarm.

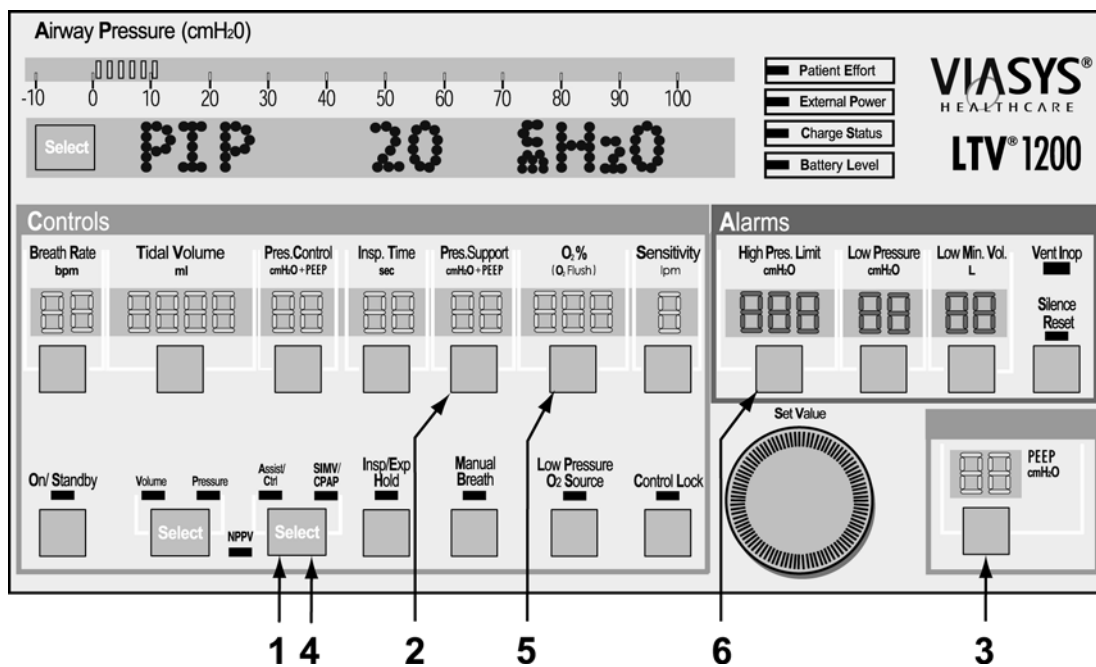

## *To Turn the Ventilator Off*

---

- 1) Disconnect the ventilator from the patient.
- 2) Push and hold the **On/Standby** button for 3 seconds. The ventilator ceases operating, the audible alarm sounds continuously and the **Vent Inop** LED is lit.
- 3) Stop the audible alarm from sounding by pushing the **Silence Reset** button.
  - Verify a confirming audible chirp sounds immediately after the alarm is silenced<sup>52</sup>
- 4) The ventilator continues to charge the internal battery as long as it is connected to an external power source.

### **NOTE**

The **Vent Inop** LED will remain lit for a minimum of 5 minutes and does not affect battery life.

### **REMARQUE**

La DEL **Vent Inop** restera allumée durant au moins 5 minutes et n'affecte en rien la durée de vie de la batterie.

---

<sup>52</sup> The audible Chirp occurs after the Inop Alarm sounds for longer than 0.8 seconds and is then silenced.

## *LTV<sup>®</sup> Ventilator Settings Checklist*

The LTV<sup>®</sup> 1200 Ventilator Settings Checklist may be used by caregivers as a reminder that all appropriate controls on the ventilator were properly set, adjusted and/or recorded.

<b>Patient Name:</b>		<b>Ordered By:</b>		<b>Date:</b>	
<b>Controls: (Fill in (x.x), or Confirm (X))</b>				<b>Check-up</b>	
Volume Mode:	- or -	Pressure Mode:	By:	Date:	
Assist Control Mode:	- or -	SIMV Mode:	By:	Date:	
CPAP Mode:	- or -	NPPV Mode:	By:	Date:	
Breath Rate:		bpm	By:	Date:	
Tidal Volume:		ml	By:	Date:	
Pressure Control:		cmH <sub>2</sub> O	By:	Date:	
Inspiratory Time:		Seconds	By:	Date:	
Pressure Support:		cmH <sub>2</sub> O	By:	Date:	
High Pressure O <sub>2</sub> %:		FIO <sub>2</sub>	By:	Date:	
Low Pressure O <sub>2</sub> %:		Lpm	By:	Date:	
Sensitivity:		Lpm	By:	Date:	
<b>Alarms: (Fill in (x.x), or Confirm (X))</b>				<b>Check-up</b>	
High Pressure Limit:		cmH <sub>2</sub> O	By:	Date:	
Low Pressure Limit:		cmH <sub>2</sub> O	By:	Date:	
Low Minute Volume:		Liters	By:	Date:	
<b>Extended Features-Alarms: (Fill in (x.x), or Confirm (X))</b>				<b>Check-up</b>	
Apnea Interval:		Seconds	By:	Date:	
High f:	HIGH f OFF	- or -	bpm	By:	Date:
High PEEP:	HI PEEP OFF	- or -	cmH <sub>2</sub> O	By:	Date:
Low PEEP:	LO PEEP OFF	- or -	cmH <sub>2</sub> O	By:	Date:
High Pressure Delay:	No Delay,	1 BRTH - or -	2 BRTH	By:	Date:
LPP Alarm:	All Breaths	- or -	VC/PC Only	By:	Date:
<b>Extended Features-Ventilator: (Fill in (x.x), or Confirm (X))</b>				<b>Check-up</b>	
Rise Time Profile:		(1 to 9)	By:	Date:	
Flow Termination:		10-40% of Peak Flow	By:	Date:	
Pressure Support Time Termination:		Seconds	By:	Date:	
Pressure Control Flow Termination:	YES	- or -	NO	By:	Date:
Leak Compensation:	ON	- or -	OFF	By:	Date:

## *Chapter 13 - CLEANING, DISINFECTING AND STERILIZING*

### *Cleaning the Ventilator*

All ventilator external surfaces should be cleaned before and after each patient use, and as may be required.

**To clean the ventilator:**

- 1) Wipe the exterior surfaces of the ventilator with a clean, damp cloth. The use of an anti-bacterial cleaning solution is recommended. Be sure to wipe away any residual cleaner.

### **CAUTION**

**Ventilator Sterilization** – To avoid irreparable damage to the LTV<sup>®</sup> 1200 ventilator, do not attempt to sterilize it.

**Cleaning Agents** – To avoid damaging the ventilator's plastic components and front panel, do not use cleaning agents containing ammonium chloride, other chloride compounds, more than 2% glutaraldehyde, phenols, or abrasive cleaners.

**Ventilator Immersion** - Do not immerse the ventilator in liquids.

**Exhalation Valve Cleaning** - Do not pour or spray liquid cleaners into the exhalation valve.

**Front Panel Cleaning** – Do not pour or spray liquid cleaners onto the front panel.

### **ATTENTION**

**Stérilisation du ventilateur** - Afin d'éviter des dommages irréparables au ventilateur de la 1200 LTV<sup>®</sup>, ne tentez pas de stériliser ce dernier.

**Produits de nettoyage** - Afin d'éviter d'endommager les composants plastiques et le panneau frontal du ventilateur, n'utilisez pas des produits de nettoyage contenant : chlorure d'ammonium, composés de chlorure, plus de 2% de glutaraldéhyde, ou phénol.

**Immersion du ventilateur** - Ne pas immerger le ventilateur dans des liquides, incluant les produits stérilisants.

**Nettoyage de la soupape d'expiration** - Ne pas asperger une solution nettoyante dans la soupape d'expiration.

**Nettoyage du panneau frontal** - Ne pas asperger des solutions nettoyantes ou les laisser s'écouler sur le panneau frontal.



## *Cleaning or replacing the Fan Filter*

---

### To clean the fan filter:

- 1) Using a small screwdriver, detach the fan filter grill from its housing.
- 2) Remove the fan filter by squeezing the foam filter gently with your fingers and pulling it out.

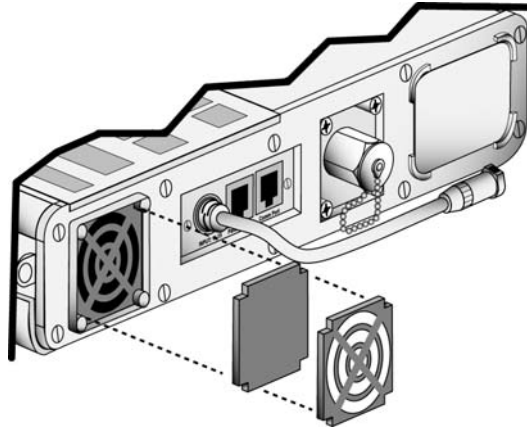

### NOTE

**Hardware Fault** -If you touch the fan blades while removing the fan filter grill or filter, a **HW FAULT** may occur. This is normal. Clear the **HW FAULT** alarm by using the **Silence Reset** button.

### REMARQUE

Si vous touchez les pales du ventilateur en enlevant le grillage du filtre ou le filtre du ventilateur, une alarme **HW FAULT** se produira. C'est une situation normale. Effacez l'alarme **HW FAULT** à l'aide du bouton Silence / Remise à zéro.

- 3) Gently bathe the filter in a solution of mild detergent and warm water.
- 4) Rinse thoroughly in warm water.
- 5) Examine the filter for excessive wear or damage. Discard and replace with a new filter if necessary.
- 6) Allow the filter to thoroughly air dry **before** reinstallation.
- 7) Reinstall the filter.
- 8) Reposition the filter grill over the filter and apply light pressure until it fully seats ("clicks") into the filter housing.

### CAUTION

**Wet or Damp Filters** - Do not install a wet or damp filter into the LTV<sup>®</sup> 1200 ventilator. This could damage the ventilator.

### ATTENTION

**Filtres mouillés ou humides** - Ne pas installer des filtres mouillés ou humides dans les ventilateurs de la 1200 LTV<sup>®</sup>. Cela pourrait endommager le ventilateur.

## *Cleaning or replacing the Inlet Filter*

---

### **To clean the Inlet Filter:**

- 1) Remove the Inlet Filter by squeezing the foam filter gently with your fingers and pulling it out.

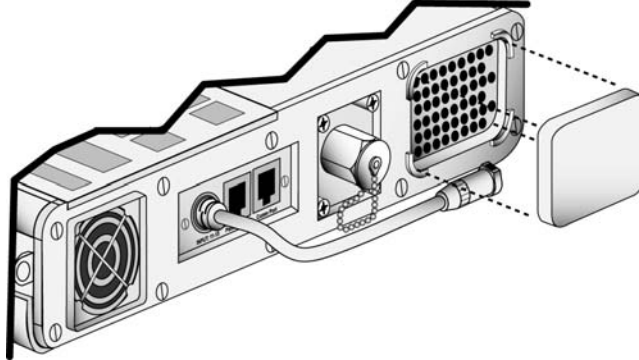

- 2) Gently bathe the filter in a solution of mild detergent and warm water.
- 3) Rinse thoroughly in warm water.
- 4) Examine the filter for excessive wear or damage. Discard and replace with a new filter if necessary.
- 5) Allow the filter to thoroughly air dry ***before*** reinstallation.
- 6) Reinstall the filter.

### **CAUTION**

**Wet or Damp Filters** - Do not install a wet or damp filter into the LTV<sup>®</sup> 1200 ventilator. This could damage the ventilator.

### **ATTENTION**

**Filtres mouillés ou humides** - Ne pas installer des filtres mouillés ou humides dans les ventilateurs de la 1200 LTV<sup>®</sup>. Cela pourrait endommager le ventilateur.

## Cleaning or Replacing the O<sub>2</sub> Inlet Filter

The O<sub>2</sub> filter should be cleaned or replaced when it becomes soiled. Failure to do this can affect ventilator performance.

### **CAUTION**

**Oxygen Supply Contamination** - The accuracy of the oxygen delivery capabilities of LTV<sup>®</sup> 1200 ventilator can be compromised by foreign debris contamination in the oxygen supply system. To reduce the risk of airborne contaminants entering the ventilator, ensure that any oxygen supply connected to the ventilator is clean, properly filtered<sup>53</sup> and that the ventilator's O<sub>2</sub> Inlet Port Cap is securely installed on the O<sub>2</sub> Inlet Port whenever the ventilator is not connected to an external oxygen supply.

### **ATTENTION**

**Contamination de la réserve d'oxygène** - La précision de la capacité d'alimentation en oxygène des ventilateurs LTV<sup>®</sup> 1200 peut être compromise par la présence de corps étrangers dans le système d'alimentation en oxygène. Afin de diminuer le risque de présence d'agents contaminants atmosphériques dans le ventilateur, assurez-vous que la réserve d'oxygène reliée au ventilateur est propre et filtrée de manière adéquate<sup>53</sup>, et que le bouchon de l'orifice d'alimentation en oxygène est correctement installé à chaque fois que le ventilateur n'est pas relié à une source d'oxygène externe.

#### **To clean or replace the O<sub>2</sub> Inlet Filter:**

- 1) If a high pressure O<sub>2</sub> source is being used, disconnect the high pressure O<sub>2</sub> hose from the oxygen block on the left side of the ventilator.
- 2) If a low pressure O<sub>2</sub> source is being used, disconnect the O<sub>2</sub> line from the barbed oxygen adapter. Unscrew and remove the barbed adapter from the oxygen block on the left side of the ventilator.

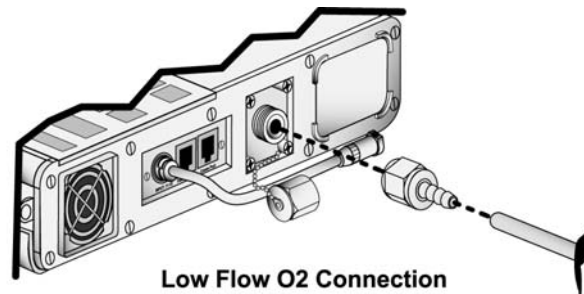
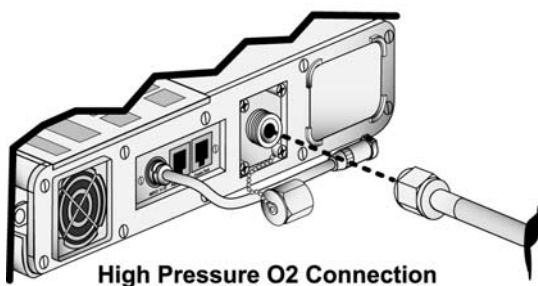

<sup>53</sup> In addition to the existing internal O<sub>2</sub> Inlet filter, P/N 14313, an External, In-Line Oxygen Filter (P/N 14470) is available from Pulmonetic Systems, Inc.

- 3) Using a pick, gently remove the rubber O-Ring from inside the O<sub>2</sub> inlet port. Use caution: Do not damage the O-Ring while removing it. Tip the ventilator to allow the O<sub>2</sub> Inlet Filter to slide out.

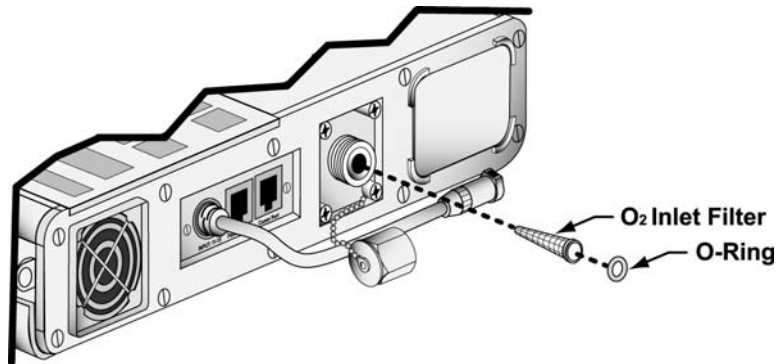

- 4) Clean the filter using a mild cleanser, warm water and a soft brush. Rinse the filter thoroughly to remove all traces of the cleanser. Allow the filter to dry completely before replacing it in the ventilator.
- 5) Inspect the filter for damage. If the filter is not intact, shows signs of damage or cannot be completely cleaned, replace it with a new O<sub>2</sub> Inlet Filter (P/N 14313) and O-Ring (P/N 10609), available from Pulmonetic Systems.
- 6) Replace the filter by sliding it back into the O<sub>2</sub> inlet port. Replace the O-Ring, making sure it is completely tucked under the retaining lip on the inside of the O<sub>2</sub> inlet port.
- 7) Reconnect the high pressure O<sub>2</sub> line or the barbed adapter and low pressure O<sub>2</sub> line.

## CAUTION

**Wet or Damp Filters** - Do not install a wet or damp filter into the LTV<sup>®</sup> 1200 ventilators. This could damage the ventilator.

## ATTENTION

**Filtres mouillés ou humides** - Ne pas installer des filtres mouillés ou humides dans les ventilateurs de la 1200 LTV<sup>®</sup>. Cela pourrait endommager le ventilateur.

## *Cleaning the Exhalation Valve and Reusable Patient Circuit*

---

### **WARNING**

**Patient Circuits** – Pulmonetic Systems' Patient Circuits, Exhalation Valve Assemblies and Water Traps are shipped clean, not sterile.

**Ultra Violet Light Sensitivity** – The material used in the tubing of the “Reusable” Patient Circuits is not UV stable. Avoid exposure of the tubing to UV light.

### **AVERTISSEMENT**

**Circuits du patient** – Les circuits du patient du Pulmonetic Systems, les valves expiratoires et les collecteurs d'eau sont expédiés propres, mais pas stériles.

**Sensibilité à la lumière ultraviolette** – Les matériaux utilisés pour la tubulure des circuits du patient ne sont pas stables sous rayons UV. Éviter d'exposer la tubulure à la lumière UV.

### **CAUTION**

**Proximal Sense Lines** - Do not remove the proximal sense lines from the patient wye.

**Care of the Exhalation Valve** - The exhalation valve is a delicate assembly and may be damaged if;

- Care is not exercised when handling or cleaning it.
- Cleaning instruments or foreign bodies are inserted into it.
- High-pressure gas nozzles are used to dry it.

**Care of Bacterial Filters** – If bacterial filters are used in conjunction with the LTV<sup>®</sup> 1200 ventilator, comply with all procedures as specified by the filter manufacturer.

### **ATTENTION**

**Conduites de détection** – N'enlevez pas les conduites de détection qui se trouvent sur les divisions en Y du circuit du patient.

**Entretien de la soupape d'expiration** - La soupape d'expiration est une pièce fragile et peut être endommagée si :

- Des précautions ne sont pas prises lors de sa manipulation ou de son nettoyage.
- Des instruments de nettoyage ou des corps étrangers sont insérés dans celle-ci.
- Des pistolets de gaz à haute-pression sont utilisés pour l'assécher

**Entretien des filtres bactériens** - Les filtres bactériens ne devraient pas être immergés dans un liquide. Un autoclave à vapeur devrait être utilisé pour le nettoyage des filtres bactériens.

## CAUTION

**Cleaning the Water Trap** – Do NOT use KlenZyme to clean Pulmonetic water traps. It will cause deterioration of the water trap material.

**Reusable Patient Circuit Components** - To avoid degradation of the reusable patient circuit components, do not exceed the following constraints:

- 50 cleaning cycles or 1 year (whichever comes first)

### Steam Autoclave:

- Pressure: 20 PSIG
- Temperature: 275°F (135°C)
- Time: 6 minutes

### Liquid Sterilizing Agent:

- The use of liquid agents containing more than 2% glutaraldehyde.

### Pasteurization:

- 30-minute warm water detergent and 30-minute 165°F (74°C) hot cycle.
- Drying in a sterile drier for more than 1 hour or 140°F (59°C).

### Gas (ETO):

- Temperature: 131°F (55°C)

**Care of the Exhalation Valve** - The exhalation valve is delicate and may be damaged if;

- Care is not exercised when handling or cleaning it.
- Cleaning instruments or foreign bodies are inserted into it.
- High-pressure gas nozzles are used to dry it.

**Differential Pressure Ports** - A low pressure air nozzle with flow less than 10 liters per minute should be used for cleaning the differential pressure ports.

**Patient Wye Installation** – After cleaning, install the patient wye in the patient circuit so the proximal sense lines are oriented up while operating.

## ATTENTION

**Nettoyage du piège à eau** – NE PAS utiliser KlenZyme pour nettoyer les pièges à eau Pulmonetic. Le cas échéant, le matériau composant le piège à eau se détériorera.

**Composants réutilisables du circuit du patient** – Pour éviter la dégradation des composants réutilisables du circuit du patient, ne dépassez pas les limites suivantes:

- 50 cycles de nettoyage ou 1 an (le premier des deux prévalant)

### Autoclave à vapeur:

- Pression : 20 lb/po<sup>2</sup>
- Température : 275°F (135°C)
- Durée : 6 minutes

### Agent de stérilisation liquide:

- L'utilisation d'agents liquide contenant plus de 2% de glutaraldéhyde.

### Pasteurisation:

- Un cycle avec détergent à l'eau tiède pendant 30 minutes et à l'eau chaude à 165°F (74°C) pendant 30 minutes.
- Séchage dans un séchoir stérile pendant plus de 1 heure ou à 140°F (59°C).

### Gaz (ETO):

- Température : 131°F (55°C)

## ATTENTION

**Entretien de la soupape d'expiration** - La soupape d'expiration est une pièce fragile et peut être endommagée si :

- Des précautions ne sont pas prises lors de sa manipulation ou de son nettoyage.
- Des instruments de nettoyage ou des corps étrangers sont insérés dans celle-ci.
- Des pistolets de gaz à haute-pression sont utilisés pour l'assécher.

**Ports de pression différentielle** - Une source de gaz à débit faible (moins de 10 ppm) doit être utilisée pour le nettoyage des fluides et de débris des ports de pression différentielle.

**Installation de la soupape d'expiration** - Après le nettoyage, installez la soupape d'expiration dans le circuit du patient de sorte que les lignes de détection soient alignées vers le haut pendant l'opération.

**For purposes of cleaning or disinfecting, the patient circuit (tubing and all accessories) must be detached from the ventilator:**

- 1) Detach the patient circuit from the ventilator.
- 2) Detach the various components from the patient circuit.

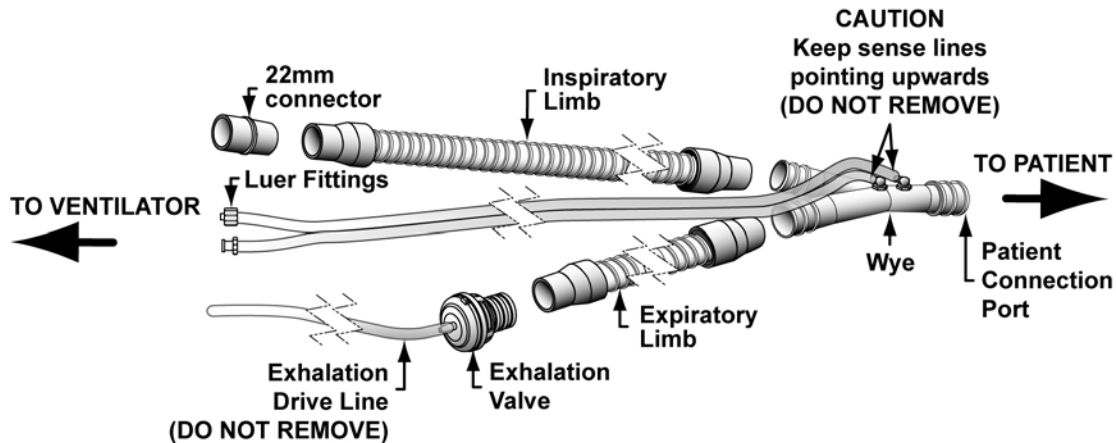

- 3) Disassemble the exhalation valve by using the small extrusion above the notch on the exhalation valve cap to pry the valve cap and valve body apart. When opened, remove the diaphragm.

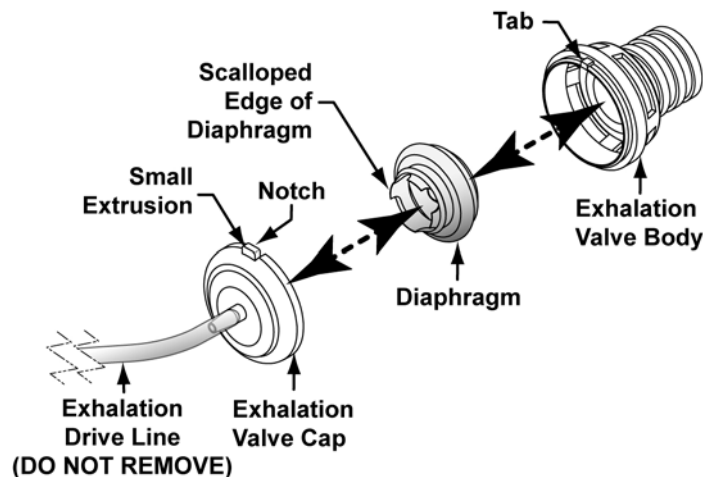

**To clean the exhalation valve, sense lines, wye and reusable patient circuit:**

- 1) Remove all particulate matter and bathe for a minimum of 10 minutes using one of the following solutions warmed to 95°F to 150°F (35°C to 65.5°C):
  - mild detergent, 50% water / 50% white vinegar solution, or liquid cleaner (e.g., KlenZyme® or other enzymatic cleaner)Ultrasonic cleaning is not recommended.
- 2) Rinse gently for 2 minutes and use a low flow air source (less than 10 L/min) to eliminate any residual fluid.  
To clean the water trap (if used), use a mild detergent solution followed by rinsing and drying with a low-flow air source.

**To high level disinfect the exhalation valve, sense lines, wye and reusable patient circuit:**

- 1) Remove all particulate matter and bathe in a glutaraldehyde solution (e.g., Cidex (2%)) for 20 minutes.
- 2) Rinse gently for 2 minutes and use a low flow air source (less than 10 L/min) to eliminate any residual fluid.

**Sterilization:**

Sterilization of the patient circuit components and water traps should follow individual institution processes or guidelines.

**To reassemble the exhalation valve and patient circuit:**

- 1) Insert the side of the diaphragm with the scalloped edge into the mating cavity on the inside of the valve cap.

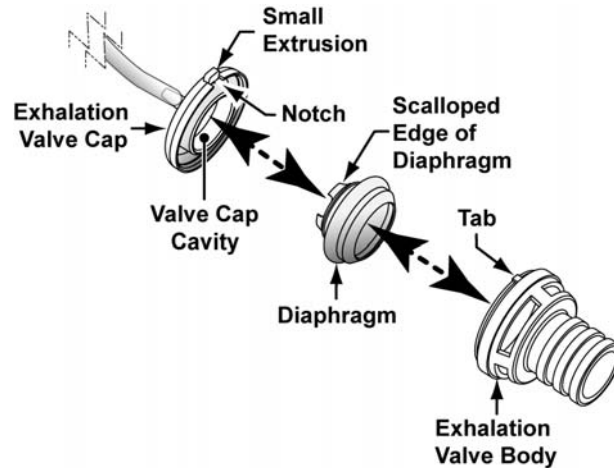

**CAUTION**

**Valve assembly** - If the diaphragm is inserted backwards when assembling the valve, it may adversely affect the operation of the ventilator. Be sure to insert the side of the diaphragm with the scalloped edge into the mating cavity on the inside of the valve cap.

**ATTENTION**

**Assemblage de la valve** – Si le diaphragme est inséré à l'envers lors de l'assemblage de la valve, il peut entraver le fonctionnement du ventilateur. S'assurer d'insérer le côté du diaphragme dont le bord est festonné dans la cavité commune à l'intérieur du couvercle de la valve.



- 2) Align the tab on the valve body with the notch on the valve cap and press until the cap and body “snap” together.

## NOTE

Be careful not to dislodge the diaphragm when snapping the parts together.

## REMARQUE

S'assurer de ne pas déplacer le diaphragme lors de l'assemblage des pièces.

- 3) Inspect the patient circuit and all accessories, replace any excessively worn or damaged components and reassemble.
- 4) Reconnect the exhalation valve drive line, the sense lines and the inspiratory limb to the mating ports on the side of the ventilator (see *Patient Breathing Circuit – Connection Instructions* in Appendix C - Installation and Checkout for detailed instructions).
- 5) Leak test the patient breathing circuit.

## WARNING

**Leak Testing Patient Circuits** – Leak test the patient circuit with all accessories connected before connection to the patient. Failing to do this can result in ineffective ventilation and possible harm to the patient. Refer to *Leak Test* in Chapter 11 – Ventilator Checkout Tests for detailed instructions.

## AVERTISSEMENT

**Essais de fuite du circuit du patient** – Faire un essai de fuite du circuit du patient une fois que tous les accessoires sont en place, avant de faire le raccordement final au patient. L'omission de cette étape peut entraîner une ventilation inefficace et pourrait blesser le patient. Pour obtenir les consignes détaillées, consulter Essai de fuite dans le Chapitre 11 – Tests de vérification du ventilateur.

## Chapter 14 - POWER AND BATTERY OPERATION

The LTV<sup>®</sup> 1200 ventilator operates on Direct Current (11 to 15 VDC), supplied by an external AC to DC power adapter, an external battery or other suitable external DC power source such as the Pulmonetic Systems Universal Power Supply or Transport Battery System. The ventilator can also be powered for short periods of time by its own internal battery (see note below).

- When the ventilator is connected to an appropriate external power source, the ventilator's internal battery is continuously charged and will reach 90% charge status within 8 hours.
- If an LTV<sup>®</sup> 1200 ventilator is allowed to operate on its internal battery to the point that the internal battery is completely depleted, the ventilator will shut down. If the ventilator remains in this state, the internal battery may recharge slightly within a few seconds / minutes and cause the ventilator to automatically restart and operate for a short period of time. This cycle can repeat several times, depending on the condition of the internal battery.

### NOTE

The **Charge Status** LED is illuminated green when the internal battery is charged to >90% of its capacity. If the **Charge Status** LED is red, is flashing amber for more than 1 hour, or does not show a green **Charge Status** indication after 24 hours, the battery is defective and should be replaced. Please immediately contact a certified Pulmonetic Systems' service technician.

**Internal Battery Use:** The internal battery is intended for use during short periods while switching between external power supply connections, emergency situations or short duration transports. The length of time the ventilator will operate on internal power is a function of many factors such as settings, charge level and condition or age of the battery; therefore, the use of the internal battery as a standard operating practice is not recommended.

### REMARQUE

Le voyant du DEL **Charge Status** est vert lorsque la pile interne est chargée à plus de 90 % de sa capacité. Si le voyant du DEL **Charge Status** est rouge, qu'il est jaune et clignote pendant plus d'une heure, ou qu'il n'affiche pas un **Charge Status** vert après 24 heures, la pile est défectueuse et il faut la changer. Veuillez communiquer immédiatement avec un technicien de service certifié par Pulmonetic Systems.

**Utilisation de la batterie interne:** La batterie interne est conçue pour être utilisée sur de courtes périodes pendant la commutation entre des connexions d'alimentation externe, les situations d'urgence ou les transports de courte durée. La durée pendant laquelle le ventilateur fonctionnera sur l'alimentation interne dépend de plusieurs facteurs tels, la configuration, le niveau de la charge et la condition ou l'âge de la batterie; l'utilisation de la batterie interne pour l'opération normale n'est donc pas recommandée.

## Using the AC Adapter

To run the ventilator from the Pulmonetic Systems AC Power Adapter:<sup>54</sup>

- 1) Attach the power connector from the AC Adapter to the ventilator as shown here.

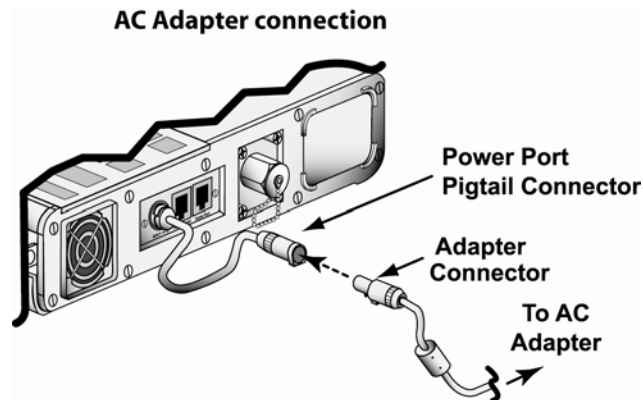

- 2) Connect the proper AC power cable (110V or 220V plug) to the AC Power Adapter.
- 3) Connect the 110V<sup>55</sup> or 220V power cable to a suitable power source. Verify the **External Power** LED shows green or amber.

### CAUTION

**Release Button** - To avoid damaging the ventilator or the power connector, push the release button on the connector before removing it from the ventilator power port or the power port pigtail connector.

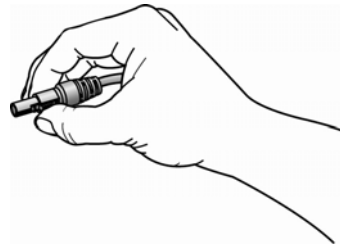

### ATTENTION

**Bouton de déclenchement** – Pour éviter d'endommager le ventilateur ou le connecteur d'alimentation, appuyer sur le bouton de déclenchement situé sur le connecteur avant de le retirer du port d'alimentation du ventilateur ou du raccord de queue de cochon du port d'alimentation.

While the ventilator is plugged in, the internal battery is continuously charged.

<sup>54</sup> Pulmonetic Systems AC Adapter, P/N 10537

<sup>55</sup> Pulmonetic Systems Power Cord, P/N 10536 or P/N 17527-001

## Using an External Battery

Optional External Batteries<sup>56</sup>, Cables<sup>57</sup> and Charger<sup>58</sup> are available from Pulmonetic Systems. The Large External Battery Pack includes a large capacity battery and hard case with a fuse and power cable and is pre-wired with a locking quick-connector. The Small External Battery Pack includes a medium capacity battery, soft bag and power cable with fuse and locking quick-connector.

### CAUTION

**External Battery Pack** - The External Battery Pack should only be connected to the LTV<sup>®</sup> 1200 ventilator using the Pulmonetic Systems External Battery Cable (PN 10802). This cable is pre-wired and properly terminated to ensure safe connection of the External Battery Pack to the ventilator.

**Release Button** - To avoid damaging the ventilator or the power connector, push the release button on the connector before removing it from the ventilator power port or the power port pigtail connector.

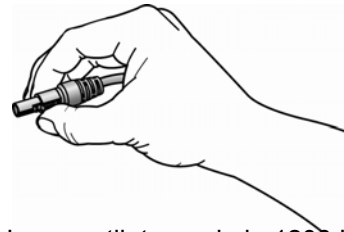

### ATTENTION

**Bloc-piles externe** – Le bloc-piles externe ne doit être branché qu'aux ventilateurs de la 1200 LTV<sup>®</sup> à l'aide du câble pour piles externes de Pulmonetic Systems (N<sup>o</sup> pièce 10802). Ce câble est précâblé et ses terminaisons assurent une connexion sécuritaire entre le bloc-piles externe et le ventilateur.

**Bouton de déclenchement** – Pour éviter d'endommager le ventilateur ou le connecteur d'alimentation, appuyer sur le bouton de déclenchement situé sur le connecteur avant de le retirer du port d'alimentation du ventilateur ou du raccord de queue de cochon du port d'alimentation.

#### To run the ventilator from an external battery:

- 1) Connect the battery cable quick-connector to the port on the external battery hard case or the soft bag.

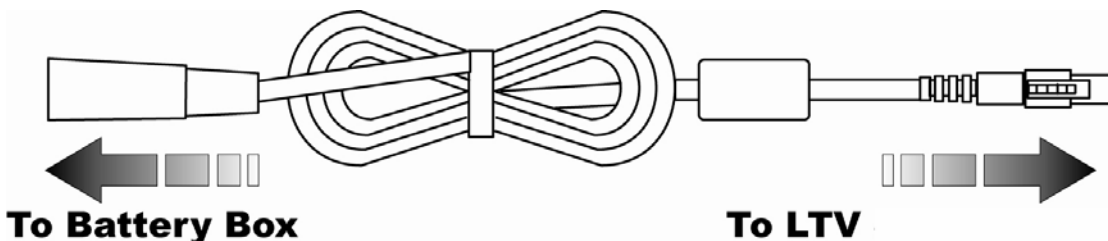

<sup>56</sup> Pulmonetic Systems External Battery P/N 10787 and Case P/N 10790.

<sup>57</sup> Pulmonetic Systems External Battery Cable P/N 10802.

<sup>58</sup> Pulmonetic Systems External Battery Charger P/N 10801.

- 2) Connect the power connector on the battery cable to the power port on the left side of the ventilator as shown here. Verify the **External Power** LED shows green or amber.

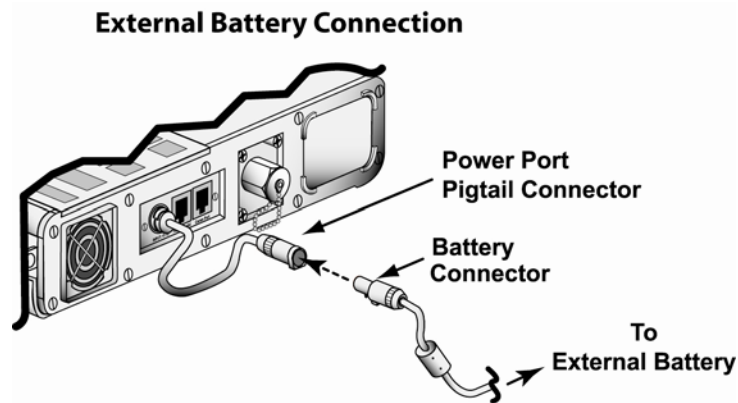

While the ventilator is connected to the external battery, the internal battery is being continuously charged.

## NOTE

The External Battery Packs can only be recharged using the Pulmonetic Systems External Battery Charger. The External Battery Pack must be disconnected from the LTV<sup>®</sup> 1200 ventilator before connecting to the External Battery Charger. The External Battery Pack can be fully recharged in 8 hours. See the instruction sheet that comes with the External Battery Charger for information on how to properly configure the charger for your AC voltage and frequency.

The external battery is a sealed lead acid battery. Some states and countries require that these batteries must be disposed of through an authorized recycling or hazardous materials center. Contact the proper agency for appropriate disposal procedures.

## REMARQUE

Les blocs-piles externes ne peuvent être rechargés qu'en utilisant le chargeur de piles externe Pulmonetic Systems. Le bloc-piles externe doit être débranché du ventilateur de la 1200 LTV<sup>®</sup> afin d'être branché au chargeur de piles externe. Il faut 8 heures pour recharger complètement le bloc-piles externe. Consultez la feuille de directives incluse avec le chargeur de piles externe pour obtenir des renseignements sur la façon de configurer adéquatement le chargeur selon la tension alternative et la fréquence dont vous disposez.

La batterie externe est une batterie à l'acide sans entretien. Certains états et pays exigent que l'on dispose de ces piles par l'entremise d'un centre autorisé de recyclage ou de matières dangereuses. Pour connaître les procédures appropriées, communiquez avec l'agence concernée.

For more detailed information on using or charging the external batteries, or for information on replacing battery box or bag fuse, see the LTV<sup>®</sup> External Battery Kit Operator's Manual.<sup>59</sup>

The battery may be set and operated from any position, but always secure the battery box in place and keep the battery box in a stable, accessible position near the LTV<sup>®</sup> ventilator. Keep all cords away from footpaths and moveable equipment, and tie them to unmoving surfaces such as the ventilator stand or bed post.

Refer to your LTV<sup>®</sup> External Battery Kit Operator's Manual (P/N 10890) for other safety information, extended operating procedures and troubleshooting techniques.

---

<sup>59</sup> LTV<sup>®</sup> Series External Battery Kit Operator's Manual, P/N 10890.

## *Using the Automobile Cigarette Lighter Adapter*

---

An optional Automobile Cigarette Lighter Adapter<sup>60</sup> is available to power the LTV<sup>®</sup> 1200 ventilator while operating in a vehicle. This adapter is designed to connect to “high power” pre-wired +12V automobile cigarette lighter or auxiliary power outlets capable of supplying at least 20 amperes of current.

- Newer vehicles have Auxiliary Power Outlets, which typically have lower contact resistance and higher amperage ratings than Automobile Cigarette Lighter Outlets and should be used when available.
- The use of third-party-installed automobile cigarette lighter-style power outlets is not recommended (i.e. on battery boxes or wheelchairs).

### **WARNING**

**Before Using Automobile Cigarette Lighter or Power Outlets** - Before using Automobile Cigarette Lighter or Power Outlets as a power source for the LTV<sup>®</sup> 1200 ventilator, assure that the ventilator's internal battery is in good condition and fully charged.

Poor cigarette lighter or power outlet connections, electrical system defects (battery, charging system, etc.), or use of vehicle accessories (air conditioner, high current lights, high power audio equipment, etc.) could result in less than the required voltage being delivered to the ventilator. If this condition occurs, the ventilator will generate a **POWER LOST** alarm and switch the ventilator's power source to the internal battery.

### **AVERTISSEMENT**

**Avant toute utilisation d'une prise d'allume-cigare ou d'une prise de courant** — Avant d'utiliser un allume-cigare ou une prise de courant comme source d'alimentation du ventilateur LTV<sup>®</sup> 1200, vérifiez que la batterie interne du ventilateur est en bon état et entièrement chargée.

L'utilisation d'un allume-cigare ou d'une prise de courant fournissant un branchement de qualité médiocre, des défauts du circuit électrique (batterie, système de charge, etc.), ou l'utilisation d'accessoires d'automobile (climatisation, phares, chaîne stéréo et haut-parleurs à forte consommation, etc.) peuvent affecter le voltage délivré au ventilateur et provoquer une sous-alimentation de celui-ci. Dans cette situation, le ventilateur déclenche une alarme **PAS ALIM SEC** et utilise la batterie interne du ventilateur comme source d'alimentation.

---

<sup>60</sup> Pulmonetic Systems Automobile Cigarette Lighter Adapter P/N 10703.

## CAUTION

**Automobile Cigarette Lighter and Power Outlets** - Automobile cigarette lighter and power outlets are normally wired for a positive center contact and ground sleeve contact. Connecting the ventilator to an improperly wired outlet will cause the adapter fuse to blow and may damage the adapter or the ventilator.

**Automobile Cigarette Lighter Outlet Power Rating** - Running a ventilator from an improperly rated automobile cigarette lighter outlet (less than 20 amperes) may cause a fuse in the automobile to blow, causing the ventilator and possibly other accessories in the automobile to stop operating.

**Automobile Cigarette Lighter Adapter** - Do not operate the ventilator from the Automobile Cigarette Lighter Adapter while starting the vehicle or when jump starting the automobile. Doing so may cause damage to the ventilator.

**Automobile Cigarette Lighter Adapter Tip** - Use care when disconnecting the Automobile Cigarette Lighter Adapter after use, its tip may be hot.

**Automobile Cigarette Lighter Outlet** – Depending on the condition of the automobile battery, whether the automobile is turned off, being started or running, automobile cigarette lighter outlets can provide varying levels of voltage (in some, the outlet only operates when the vehicle is running). Verify which power source the ventilator is using by checking the **External Power** LED on the ventilator.

## ATTENTION

**Allume-cigare et prises de courant** – L'allume-cigare et les prises de courant sont habituellement câblés de façon à obtenir un contact central positif et un contact du manchon à la terre. Le branchement du ventilateur dans une prise qui n'est pas câblée adéquatement aura pour effet de faire sauter le fusible de l'adaptateur et pourrait endommager l'adaptateur ou le ventilateur.

**Puissance nominale des prises d'allume-cigare** – Le branchement d'un ventilateur à une prise d'allume-cigare qui ne possède pas la tension suffisante (moins de 20 ampères) peut faire griller un fusible de l'automobile, causant ainsi l'arrêt du ventilateur et éventuellement, celui d'autres accessoires de l'automobile.

**Adaptateur pour allume-cigare** – Ne faites pas fonctionner le ventilateur à l'aide de l'adaptateur pour allume-cigare lorsque vous démarrez le véhicule ou lorsque vous faites une connexion provisoire de la batterie d'un véhicule. Vous pourriez ainsi endommager le ventilateur.

**Embout adaptateur pour allume-cigarette d'automobile** - Après l'utilisation, débrancher l'adaptateur pour allume-cigarette d'automobile avec précaution car son embout peut être chaud.

**Prise d'allume-cigare d'automobile** – Selon la condition de la batterie de l'automobile, si le moteur est coupé, démarré ou est en marche, les prises d'allume-cigare d'une automobile peut générer des niveaux de tension variés (sur certains modèles, la prise ne fonctionne que si le moteur est en marche). Vérifier la source d'alimentation utilisée par le ventilateur indiquée par la DEL **External Power** du ventilateur.



## CAUTION

**Release Button** - To avoid damaging the ventilator or the power connector, push the release button on the connector before removing it from the ventilator power port or the power port pigtail connector.

## ATTENTION

**Bouton de déclenchement** – Pour éviter d'endommager le ventilateur ou le connecteur d'alimentation, appuyer sur le bouton de déclenchement situé sur le connecteur avant de le retirer du port d'alimentation du ventilateur ou du raccord de queue de cochon du port d'alimentation.

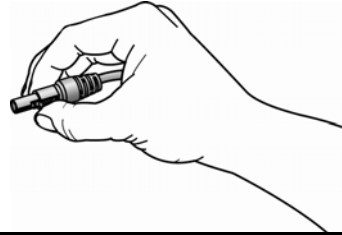

### To run the ventilator from an automobile cigarette lighter:

- 1) With the ventilator **NOT** connected to the outlet, start the automobile.
- 2) Connect the Automobile Cigarette Lighter Adapter to the automobile cigarette lighter or power outlet on the vehicle and verify the LED on the adapter shows green.
  - Do not use a DC extension cord between the automobile cigarette lighter adapter and the automobile cigarette lighter or power outlet port.



- 3) Attach the power connector of the adapter to the ventilator.

### External Power Connection

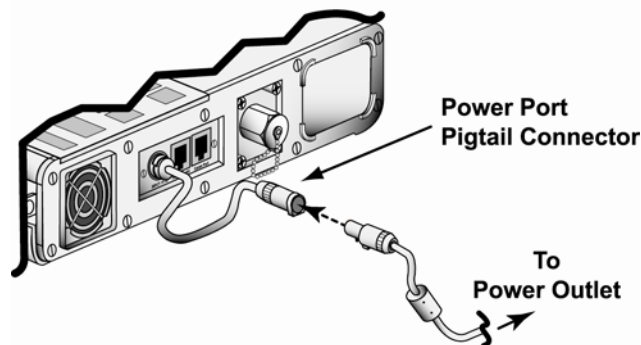

4) Verify the ventilator is being powered by the vehicle battery, through the Automobile Cigarette Lighter Adapter.

- The vehicle battery is powering the ventilator if the **External Power** LED shows green.
- An amber **External Power** LED and/or a **POWER LOW** alarm indicates the external power level is low.

Immediately reconnect the ventilator to an alternate power source (i.e. the AC Adapter or External Battery) until the cause of the problem (Automobile Cigarette Lighter Adapter cable connection or the vehicle battery or power outlet), has been identified and corrected.

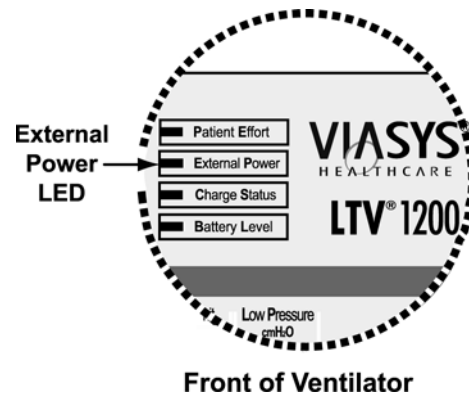

- **POWER LOST** alarm indicates external power voltage has dropped below the usable level and the ventilator has switched to internal power.

Immediately reconnect the ventilator to an alternate power source (i.e. the AC Adapter or External Battery) until the cause of the problem (Automobile Cigarette Lighter Adapter cable connection or the vehicle battery or power outlet), has been identified and corrected.

## NOTE

The Automobile Cigarette Lighter Adapter contains a fuse and is designed to protect the LTV<sup>®</sup> ventilator from typical automobile power transients. The green LED on the adapter indicates the adapter is connected and operating correctly. If the LED does not light, the adapter may not be properly seated in the outlet or the fuse may be blown. Try reseating or turning the adapter to create a better connection or change the fuse (see *Chapter 14 - Replacing the Automobile Adapter Fuse*).

## REMARQUE

L'adaptateur pour allume-cigare contient un fusible et est conçu pour protéger les ventilateurs de la 1200 LTV<sup>®</sup> contre les transitoires d'alimentation des automobiles. Le voyant DEL vert de l'adaptateur indique que l'adaptateur est branché et qu'il fonctionne adéquatement. Si le voyant ne s'allume pas, l'adaptateur n'est peut-être pas bien installé dans la prise ou le fusible est peut-être sauté. Essayer de replacer ou de tourner l'adaptateur de manière à obtenir un meilleur raccordement ou changer le fusible (se reporter au *Chapitre 14 – Remplacement du fusible de l'adaptateur*).

While the ventilator is connected to the Automobile Cigarette Lighter Adapter, the internal battery is being continuously charged.

## *Replacing the Automobile Adapter Fuse*

---

### **To replace the fuse:**

- 1) Unscrew the knurled nut.
- 2) Remove the contact point, nut, fuse and spring as shown below. Be careful not to lose the internal spring, as the adapter will not operate correctly without it.
- 3) Replace the spring and new fuse as shown.
- 4) Ensure that the retaining ring is properly in place.
- 5) Replace the contact point and tighten the nut.

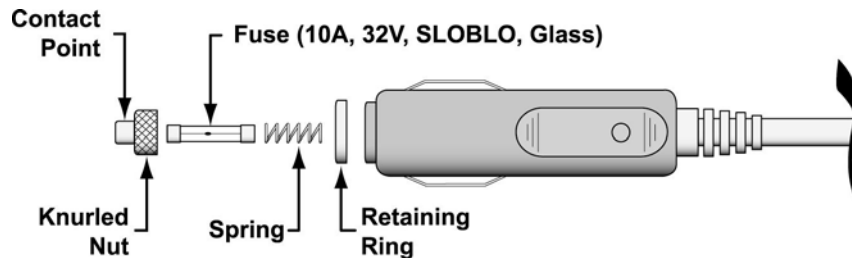

## *The Universal Power Supply (UPS)*

---

The Pulmonetic Systems Universal Power Supply kit is a rechargeable external power source and backup system for Pulmonetic Systems' devices. It has the following features:

- AC/DC Converter
- Backup Battery Charger
- **Power and Charge Status** LED
- Audible and visual alarms to indicate loss of mains power

The Universal Power supply provides an AC derived DC power source which is backed up by a rechargeable 12 volt sealed lead - acid battery. It can power the ventilator and the graphics monitor. For more information refer to the UPS Operator's Manual, P/N 14492.

## *The Transport Battery System (TBS)*

---

The TBS is a portable, re-chargeable external power source for the LTV<sup>®</sup> ventilators. It has the following features:

- Two no-maintenance re-chargeable Lithium Ion batteries providing up to six hours of mobile power for the LTV<sup>®</sup>.
- The TBS is easy and convenient to set-up and operate and the system includes a battery charger for use when the TBS has been disconnected from the ventilator

For more information about the TBS, see the Transport Battery System Operator's Manual, P/N 17216-001.

## *Caring for the Internal Battery*

---

The LTV<sup>®</sup> 1200 ventilator uses a rechargeable, sealed lead acid internal battery.

### **To preserve maximum battery life:**

- Fully recharge the battery every 2 months while the ventilator is in storage. Recharge the battery by plugging the ventilator into an AC power source for 24 hours. If the battery **Charge Status** LED is not illuminated green within 24 hours, or if it is illuminated red, immediately contact a certified Pulmonetic Systems' service technician or Pulmonetic Systems.
- Store the ventilator at temperatures less than 60°C (140°F).

## **CAUTION**

**Storage Temperature** - Storing the LTV<sup>®</sup> 1200 ventilator at temperatures above 60°C (140°F) for long periods can damage the internal battery and cause expected battery duration to degrade.

**Internal Battery Use:** The internal battery is intended for use during short periods while switching between external power supply connections, emergency situations or short duration transports. The length of time the ventilator will operate on internal power is a function of many factors such as settings, charge level and condition or age of the battery; therefore, the use of the internal battery as a standard operating practice is not recommended.

## **ATTENTION**

**Température d'entreposage** - L'entreposage du ventilateur de la 1200 série LTV<sup>®</sup> à des températures supérieures à 60° C (140° F) durant des périodes prolongées peut endommager la pile interne et causer l'usure prématurée de la pile.

**Utilisation de la batterie interne:** La batterie interne est conçue pour être utilisée sur de courtes périodes pendant la commutation entre des connexions d'alimentation externe, les situations d'urgence ou les transports de courte durée. La durée pendant laquelle le ventilateur fonctionnera sur l'alimentation interne dépend de plusieurs facteurs tels, la configuration, le niveau de la charge et la condition ou l'âge de la batterie; l'utilisation de la batterie interne pour l'opération normale n'est donc pas recommandée.

## *Battery Replacement*

---

When necessary, the LTV<sup>®</sup> 1200 ventilator's internal battery can be replaced by a trained service technician. To replace the LTV internal battery, refer to the instructions for use provided with the replacement battery, P/N 11636.

## *Battery Disposal*

---

The LTV<sup>®</sup> 1200 ventilator uses sealed lead acid batteries. Some jurisdictions consider these batteries hazardous materials subject to special disposal regulations. Contact the proper agency for information on permissible methods of disposing of used batteries.



## Chapter 15 - TROUBLESHOOTING

This chapter describes troubleshooting for the LTV<sup>®</sup> 1200 ventilator. Some problems can result from improper operation and can easily be corrected without any modification to the ventilator. Other problems may require that the ventilator be recalibrated or have parts replaced.

**Do not attempt to repair or replace any part of the ventilator unless you are trained and authorized for service on the LTV<sup>®</sup> 1200 ventilator.**

**This chapter is organized into five sections:**

Displays and Buttons (See page 15-2)	Includes problems with control and window displays and with setting controls.
Ventilator Performance (See page 15-6)	Includes problems with delivered or monitored pressure, volume or PEEP, accuracy, sensitivity and triggering.
Power and Battery Operation (See page 15-15)	Includes problems with turning the ventilator on, operating from external power sources, battery operation or duration, and vent inops.
Alarms (See page 15-17)	Includes problems with recurring alarms.
Checkout Test Failures (See page 15-23)	Includes problems detected while performing the VENT CHECK tests.
Test Lung Operation (See page 15-25)	Includes problems encountered when operating the ventilator with a test lung.

The troubleshooting tables are organized by symptom, then by possible causes and methods of diagnosing and resolving the problem. If you do not find the symptom you are looking for under one section, you may find it listed under another section, or you may be able to diagnose the problem by reading sections with related symptoms. For information on resolving problems that are not listed here, contact Pulmonetic Systems.

## Displays and Buttons

Some of the symptoms listed in this section are part of the normal operation of the ventilator and do not indicate any problem with the ventilator. They are included here for completeness.

Symptoms	Possible Causes	What to Do
<b>Pres. Control</b> display flashing.	Pressure Control breath terminated by flow - <b>PC FLOW TERM</b> is set to on.	Pressure Control breaths are normally terminated when the set inspiratory time expires. Flow termination of Pressure Control breaths is allowed when <b>PC FLOW TERM</b> is set to <b>ON</b> (see page 10-11.) When a Pressure Control breath is terminated by flow instead of time, the <b>Pres. Control</b> display is flashed.
<b>Pres. Support</b> display flashing.	Pressure support breath terminated by time - set under <b>TIME TERM</b> .	Pressure support breaths are normally terminated when the flow drops below the set percentage of the peak flow. Pressure support breaths may also terminate on time when the variable time limit is reached before the flow drops to the set level. (See pages 10-9 and 10-10 for an explanation of the <b>FLOW TERM</b> and <b>TIME TERM</b> features.) When a pressure support breath is terminated based on time, the <b>Pres Support</b> display is flashed.
<b>High Pres. Limit</b> display flashing.	<b>HIGH PRES</b> alarm occurred.	The <b>High Pres. Limit</b> display is flashed and the <b>HIGH PRES</b> message is displayed when a high pressure alarm occurs. The display will continue to flash even after the condition clears. (See page 6-4 for an explanation of the <b>HIGH PRES</b> alarm feature.)
<b>Low Pressure</b> display flashing.	<b>LOW PRES</b> alarm occurred.	The <b>Low Pressure</b> display is flashed and the <b>LOW PRES</b> message is displayed when a low pressure alarm occurs. The display will continue to flash even after the condition clears. (See page 6-12 for an explanation of the <b>LOW PRES</b> alarm feature.)
<b>Low Min Vol</b> display flashing.	<b>LOW MIN VOL</b> alarm occurred.	The <b>Low Min Vol</b> display is flashed and the <b>LOW MIN VOL</b> message is displayed when a low minute volume alarm occurs. The display will continue to flash even after the condition clears. (See page 6-11 for an explanation of the <b>LOW MIN VOL</b> alarm feature.)
<b>O<sub>2</sub> % (O<sub>2</sub> Flush)</b> display flashing.	<b>LOW O<sub>2</sub> PRES</b> or <b>HIGH O<sub>2</sub> PRES</b> alarm occurred.	The <b>O<sub>2</sub> % (O<sub>2</sub> Flush)</b> display is flashed and the <b>LOW O<sub>2</sub> PRES</b> or <b>HIGH O<sub>2</sub> PRES</b> message is displayed when a low or high O <sub>2</sub> pressure alarm occurs. The display will continue to flash even after the condition clears. (See pages 9-19 and 9-12 for an explanation of the <b>LOW O<sub>2</sub> PRES</b> and <b>HIGH O<sub>2</sub> PRES</b> alarm features.)

Symptoms	Possible Causes	What to Do
Control display flashing when setting a control.	Control setting is limited.	A control's value may be limited by the current settings of other controls. (See page 5-5 for an explanation of Control Limiting.)
A display or LED does not illuminate.	Internal problem with the ventilator.	Do a display test (see page 11-4 for instructions.) If the display or LED does not illuminate, immediately contact a certified Pulmonetic Systems' service technician.
Ventilator is running but displays are turned off.	Displays are blanked while on battery power.	To conserve battery life while running from the internal battery, most of the displays are turned off when no changes are made to the control settings for 60 seconds. To turn the displays back on, touch any control or button or turn the <b>Set Value</b> knob.
	Internal problem with the ventilator.	Do a display test (see page 11-4 for instructions.) If the display or LED does not illuminate, immediately contact a certified Pulmonetic Systems' service technician.
A control doesn't operate. <b>Set Value</b> knob doesn't operate.	Control not active in selected mode.	If a control is dimmed, it is not active in the currently selected mode and changing it's setting does not affect ventilation. (See page 5-4 for an explanation of Bright, Dim and Blank Control Displays.)
	Controls are locked.	If the controls are locked, a <b>LOCKED</b> message will be displayed when a control is selected. To unlock in <b>EASY</b> mode, push the <b>Control Lock</b> button. To unlock in <b>HARD</b> mode, push and hold the <b>Control Lock</b> button for 3 seconds. (See page 10-14 for an explanation of the <b>CTRL UNLOCK</b> feature and <b>Control Lock</b> button.)
	Control is not selected.	Before a control value can be changed, the control must be selected. To select a control, push the associated button. When a control is selected it is displayed at normal intensity and all other controls are dimmed. (See page 5-2 for an explanation of how to use the controls.)
	Controls are limited.	A control's value may be limited by the current settings of other controls. To change the value of the current control, change the value of the flashing controls. (See page 5-5 for an explanation of Control Limiting.)
	Internal problem with the ventilator.	Do a control test (see page 11-6 for instructions.) If the control does not operate, immediately contact a certified Pulmonetic Systems' service technician.



Symptoms	Possible Causes	What to Do
Can't unlock the controls.	Hard unlock method selected under <b>CTRL UNLOCK</b> .	Two unlock methods are available on the LTV <sup>®</sup> ventilator: (See pages 5-6 and 10-14 for an explanation of <b>CTRL UNLOCK</b> .) To unlock in <b>EASY</b> mode, push the <b>Control Lock</b> button. To unlock in <b>HARD</b> mode, push and hold the <b>Control Lock</b> button for 3 seconds.
<b>Volume Pressure</b> mode button does not operate, both LEDs are off.	Wrong model selected in maintenance mode.	Immediately contact a certified Pulmonetic Systems' service technician.
<b>Pres. Control</b> button does not operate, associated display is off.	Wrong model selected in maintenance mode.	Immediately contact a certified Pulmonetic Systems' service technician.
<b>O<sub>2</sub> % (O<sub>2</sub> Flush)</b> button does not operate, associated display is off.	Wrong model selected in maintenance mode.	Immediately contact a certified Pulmonetic Systems' service technician.
<b>Low Pressure O<sub>2</sub> Source</b> button associated LED does not operate.	Wrong model selected in maintenance mode.	Immediately contact a certified Pulmonetic Systems' service technician.
<b>LMV OFF</b> is displayed.	Low Minute Volume alarm is turned off.	This is an informational message only (see <i>Chapter 9 - LMV OFF</i> for an explanation of this feature).
<b>LMV LPPS OFF</b> is displayed.	Low Minute Volume alarm is turned off and the LPP ALARM has been set to <b>VC/PC ONLY</b> .	This is an informational message only (see <i>Chapter 9 - LMV LPPS OFF</i> for an explanation of this feature).
<b>LPPS OFF</b> is displayed.	LPP ALARM has been set to <b>VC/PC ONLY</b> .	This is an informational message only (see <i>Chapter 9 - LPPS OFF</i> for an explanation of this feature).
<b>f PEEP OFF</b> is displayed.	The High Breath Rate and High PEEP alarms are turned off.	This is an informational message only (see <i>Chapter 9 - f PEEP OFF</i> for an explanation of this feature).
<b>HI PEEP OFF</b> is displayed.	The High PEEP alarm is turned off.	This is an informational message only (see <i>Chapter 9 - HI PEEP OFF</i> for an explanation of this feature).
<b>HIGH f OFF</b> is displayed.	The High Breath Rate alarm is turned off.	This is an informational message only (see <i>Chapter 9 - HIGH f OFF</i> for an explanation of this feature).
<b>HI f/Vt OFF</b> is displayed.	The SBT High f/Vt alarm is turned off during the SBT mode of ventilation.	This is an informational message only (see <i>Chapter 9 - HI f/Vt OFF</i> for an explanation of this feature).

<b>Symptoms</b>	<b>Possible Causes</b>	<b>What to Do</b>
<b>LO f/Vt OFF</b> is displayed.	The SBT Low f/Vt alarm is turned off during the SBT mode of ventilation.	This is an informational message only (see Chapter 9 - <i>LO f/Vt OFF</i> for an explanation of this feature).
<b>LO PEEP OFF</b> is displayed.	The Low PEEP alarm is turned off.	This is an informational message only (see Chapter 9 - <i>LO PEEP OFF</i> for an explanation of this feature).
<b>SBT f OFF</b> is displayed.	The SBT High Breath Rate and SBT Low Breath Rate alarms are turned off during the SBT mode of ventilation.	This is an informational message only (see Chapter 9 - <i>SBT f OFF</i> for an explanation of this feature).
<b>SBT f/Vt OFF</b> is displayed.	The SBT High f/Vt and SBT Low f/Vt alarms are turned off during the SBT mode of ventilation.	This is an informational message only (see Chapter 9 - <i>SBT f/Vt OFF</i> for an explanation of this feature).
<b>SBT HI f OFF</b> is displayed.	The SBT High Breath Rate alarm is turned off during the SBT mode of ventilation.	This is an informational message only (see Chapter 9 - <i>SBT HI f OFF</i> for an explanation of this feature).
<b>SBT LO f OFF</b> is displayed.	The SBT Low Breath Rate alarm is turned off during the SBT mode of ventilation.	This is an informational message only (see Chapter 9 - <i>SBT LO f OFF</i> for an explanation of this feature).
<b>SBT TIME</b> is displayed.	The SBT mode of ventilation will end in two (2) minutes.	This is an informational message only (see Chapter 9 - <i>SBT TIME</i> for an explanation of this feature).

## Ventilator Performance

Symptoms	Possible Causes	What to Do
Ventilator is autocycling, monitored volumes are very small, <b>RT XDCR DATA</b> item <b>FTx</b> shows negative flows during exhalation and positive flows during inspiration.	Sense lines are reversed.	The sense lines are not designed to be removed from either the wye or the luer fittings. If the sense lines have been removed and replaced incorrectly, they may not seal correctly when replaced. Replace the patient wye and sense lines with a known good assembly.
Ventilator won't allow patient to exhale.	Diaphragm installed backwards or incorrectly seated in exhalation valve.	Open the exhalation valve and remove the diaphragm. Reseat the diaphragm and snap the valve cap back in place. See page 13-9 for a diagram of correct exhalation valve assembly.
	Sense lines occluded or pinched.	Check high and low pressure sense lines to be sure they are correctly attached and securely seated at both the ventilator and wye ends. Verify lines are not occluded or pinched.
	Internal problem with the ventilator.	Immediately contact a certified Pulmonetic Systems' service technician.
Set pressure not reached and turbine is humming. Turbine sounds like inspiration even during exhalation.	Failed calibration or internal problem with the ventilator.	Immediately contact a certified Pulmonetic Systems' service technician.
Monitored volume is high. Delivered volume is high.	Very small ET tube connected directly to wye.	A very small ET tube connected directly to the wye may cause turbulence that causes the flow differential to be read incorrectly. To reduce this turbulence, add a short larger bore extension between the ET tube and wye. In this case, the monitored volume is high, but the delivered volume is accurate.

Symptoms	Possible Causes	What to Do
<p><b>continued...</b>  <i>Monitored volume is high.</i>  <i>Delivered volume is high.</i></p>	<p>Low side sense line or elbow at patient wye loose or leaking.  High or low sense lines are occluded.  High or low sense ports in the wye are occluded.</p>	<p>Check high and low pressure sense lines to be sure they are correctly attached and securely seated at both the ventilator and wye ends.  Check the luer fitting connections for leaks.  Check the elbow connectors at the wye to be sure they have not loosened or been broken loose.  Verify lines are not occluded or pinched.</p>
	<p>Sense lines are reversed.</p>	<p>The sense lines are not designed to be removed from either the wye or the luer fittings. If the sense lines have been removed and replaced incorrectly, they may not seal correctly when replaced. Replace the patient wye and sense lines with a known good assembly.</p>
	<p>Failed autozero.</p>	<p>Perform an autozero under <b>XDCR ZERO</b>. See page 10-27 for more information.</p>
	<p>Failed calibration or internal problem with the ventilator.</p>	<p>Immediately contact a certified Pulmonetic Systems' service technician.</p>
<p>Delivered volume is twice the set volume.</p>	<p><b>VHome</b> setting does not match flow valve.</p>	<p>Immediately contact a certified Pulmonetic Systems' service technician.</p>
<p>Monitored volume is low.  Delivered volume is low.</p>	<p>Circuit leak.</p>	<p>Do a leak test and reseal or replace the leaking parts or connections. See page 11-8 for instructions.</p>
	<p>High or low side sense line or elbow at patient wye loose or leaking.  High or low sense lines are occluded.  High or low sense ports in the wye are occluded.</p>	<p>Check high and low pressure sense lines to be sure they are correctly attached and securely seated at both the ventilator and wye ends.  Check the luer fitting connections for leaks.  Check the elbow connectors at the wye to be sure they have not loosened or been broken loose.  Verify lines are not occluded or pinched.</p>

Symptoms	Possible Causes	What to Do
<p><b>continued...</b></p> <p><i>Monitored volume is low.</i></p> <p><i>Delivered volume is low.</i></p>	<p>Exhalation drive line leaking or loose.</p> <p>Exhalation valve leaking during inspiration.</p>	<p>Check the exhalation drive line at both the ventilator and exhalation valve ends. Verify the line is securely seated and not leaking.</p> <p>Verify the exhalation valve is not leaking during inspiration. If it is leaking, open the exhalation valve and remove the diaphragm. Reseat the diaphragm. See page 13-9 for a diagram of correct exhalation valve assembly.</p> <p>If necessary, replace the exhalation diaphragm, or exhalation valve with a new one.</p>
	<p>Sense lines are reversed.</p>	<p>The sense lines are not designed to be removed from either the wye or the luer fittings. If the sense lines have been removed and replaced incorrectly, they may not seal correctly when replaced. Replace the patient wye and sense lines with a known good assembly.</p>
	<p>Leak Compensation is not on.</p>	<p>Verify that the Leak Compensation extended features option is set to <b>On</b> (default setting is on). See page 10-12 for instructions.</p>
	<p>Failed autozero.</p>	<p>Perform an autozero under <b>XDCR ZERO</b>. See page 10-27 for more information.</p>
	<p>Failed calibration or internal problem with the ventilator.</p>	<p>Immediately contact a certified Pulmonetic Systems' service technician.</p>
<p>Delivered volume is half the set volume.</p>	<p><b>VHome</b> setting does not match flow valve.</p>	<p>Immediately contact a certified Pulmonetic Systems' service technician.</p>
<p>Delivered pressure is low, PEEP is low, ventilator is autocycling.</p> <p>Delivered pressure is low.</p> <p>Monitored pressure is low.</p>	<p>Circuit leak.</p>	<p>Run a leak test and reseat or replace the leaking parts or connections. See page 11-8 for instructions.</p>

Symptoms	Possible Causes	What to Do
<p><b>Continued...</b>  <i>Delivered pressure is low, PEEP is low, ventilator is autocycling.</i>  <i>Delivered pressure is low.</i>  <i>Monitored pressure is low.</i></p>	<p>High or low side sense line or elbow at patient wye loose or leaking.  High or low sense lines are occluded.  High or low sense ports in the wye are occluded.</p>	<p>Check high and low pressure sense lines to be sure they are correctly attached and securely seated at both the ventilator and wye ends.  Check the luer fitting connections for leaks.  Check the elbow connectors at the wye to be sure they have not loosened or been broken loose.  Verify lines are not occluded or pinched.  Check the exhalation drive line at both the ventilator and exhalation valve ends. Verify the line is securely seated and not leaking.</p>
	<p>Exhalation drive line leaking or loose.  Exhalation valve leaking during inspiration.</p>	<p>Check the exhalation drive line at both the ventilator and exhalation valve ends. Verify the line is securely seated and not leaking.  Verify the exhalation valve is not leaking during inspiration. If it is leaking, open the exhalation valve and remove the diaphragm. Reseat the diaphragm. See page 13-9 for a diagram of correct exhalation valve assembly.  If necessary, replace the exhalation diaphragm, or exhalation valve with a new one.</p>
	<p>Sense lines are reversed.</p>	<p>The sense lines are not designed to be removed from either the wye or the luer fittings. If the sense lines have been removed and replaced incorrectly, they may not seal correctly when replaced. Replace the patient wye and sense lines with a known good assembly.</p>
	<p>Leak Compensation is not on.</p>	<p>Verify that the Leak Compensation extended features option is set to <b>On</b> (default setting is on). See page 10-12 for instructions.</p>
	<p>Failed autozero.</p>	<p>Perform an autozero under <b>XDCR ZERO</b>. See page 10-27 for more information.</p>
	<p>Failed calibration or internal problem with the ventilator.</p>	<p>Immediately contact a certified Pulmonetic Systems' service technician.</p>

Symptoms	Possible Causes	What to Do
Delivered pressure is high. Monitored pressure is high.	Diaphragm is incorrectly seated in exhalation valve.	Open the exhalation valve and remove the diaphragm. Reseat the diaphragm and snap the exhalation valve in place. See page 13-9 for a diagram of correct exhalation valve assembly.
	High or low side sense line or elbow at patient wye loose or leaking. High or low sense lines are occluded. High or low sense ports in the wye are occluded.	Check high and low pressure sense lines to be sure they are correctly attached and securely seated at both the ventilator and wye ends. Check the luer fitting connections for leaks. Check the elbow connectors at the wye to be sure they have not loosened or been broken loose. Verify lines are not occluded or pinched. Check the exhalation drive line at both the ventilator and exhalation valve ends. Verify the line is securely seated and not leaking.
	Failed autozero.	Perform an autozero under <b>XD CR ZERO</b> . See page 10-27 for more information.
	Failed calibration or internal problem with the ventilator.	Immediately contact a certified Pulmonetic Systems' service technician.
Delivered pressure increases towards end of inspiration.	<b>VHome</b> setting does not match flow valve.	Immediately contact a certified Pulmonetic Systems' service technician.
Delivered flow is high. Delivered flow is low.	Disconnected Exhalation Drive Line. Leaks in the Patient Circuit.	Verify lines are not occluded or pinched. Check the exhalation drive line at both the ventilator and exhalation valve ends. Verify the line is securely seated and not leaking.
	Failed autozero.	Perform an autozero under <b>XD CR ZERO</b> . See page 10-27 for more information.
	Failed calibration or internal problem with the ventilator.	Immediately contact a certified Pulmonetic Systems' service technician.
Bias flow is 20 lpm or 5 lpm instead of 10 lpm.	<b>VHome</b> setting does not match flow valve.	Immediately contact a certified Pulmonetic Systems' service technician.

Symptoms	Possible Causes	What to Do
Sensitivity does not appear to be accurate. Ventilator is autocycling.	Circuit leak.	Run a leak test and reseal or replace the leaking parts or connections. See page 11-8 for instructions.
	Sense lines are reversed.	The sense lines are not designed to be removed from either the wye or the luer fittings. If the sense lines have been removed and replaced incorrectly, they may not seal correctly when replaced. Replace the patient wye and sense lines with a known good assembly.
	High or low side sense line or elbow at patient wye loose or leaking. High or low sense lines are occluded. High or low sense ports in the wye are occluded.	Check high and low pressure sense lines to be sure they are correctly attached and securely seated at both the ventilator and wye ends. Check the luer fitting connections for leaks. Check the elbow connectors at the wye to be sure they have not loosened or been broken loose. Verify lines are not occluded or pinched. Check the exhalation drive line at both the ventilator and exhalation valve ends. Verify the line is securely seated and not leaking.
	Pressure Control or Pressure Support set below PEEP.	Verify the control values are appropriately set.
	Failed autozero.	Perform an autozero under <b>XD CR ZERO</b> . See page 10-27 for more information.
	Leak Compensation is not on.	Verify that the Leak Compensation extended features option is set to <b>On</b> (default setting is on). See page 10-12 for instructions.
	Failed calibration or internal problem with the ventilator.	Immediately contact a certified Pulmonetic Systems' service technician.
O <sub>2</sub> % is high.	O <sub>2</sub> inlet pressure too high when Low O <sub>2</sub> Source selected. O <sub>2</sub> inlet flow too high when Low O <sub>2</sub> Source selected.	Verify the low pressure O <sub>2</sub> inlet has been correctly calculated and set using the Input O <sub>2</sub> Flow Chart (see page 6-15). Pulmonetic Systems recommends the use of an O <sub>2</sub> monitor to verify delivered O <sub>2</sub> %. Adjust the entrained O <sub>2</sub> flow so the monitored value shows the desired FIO <sub>2</sub> . (See pages 6-13 and 6-18 for information on using the Low O <sub>2</sub> Source and O <sub>2</sub> % features.)



Symptoms	Possible Causes	What to Do
Continued... <i>O<sub>2</sub>% is high.</i>	Low Pressure O <sub>2</sub> Source incorrectly selected.	Verify that the Low Pressure O <sub>2</sub> Source is on when using a low flow, low pressure source and off when using a high pressure source. (See pages 6-13 and 6-18 for information on using the Low Pressure O <sub>2</sub> Source and O <sub>2</sub> % features.)
	Failed calibration or internal problem with the ventilator.	Immediately contact a certified Pulmonetic Systems' service technician.
	<b>VHome</b> setting does not match flow valve.	Immediately contact a certified Pulmonetic Systems' service technician.
<i>O<sub>2</sub>% is low.</i>	O <sub>2</sub> inlet flow too low when Low Pressure O <sub>2</sub> Source selected.	Verify the low pressure O <sub>2</sub> inlet has been correctly calculated and set using the Input O <sub>2</sub> Flow Chart (see page 6-15).  Pulmonetic Systems recommends the use of an O <sub>2</sub> monitor to verify delivered O <sub>2</sub> %. Adjust the entrained O <sub>2</sub> flow so the monitored value shows the desired FIO <sub>2</sub> . (See pages 6-13 and 6-18 for information on using the Low Pressure O <sub>2</sub> Source and O <sub>2</sub> % features.)
	Failed calibration or internal problem with the ventilator.	Immediately contact a certified Pulmonetic Systems' service technician.
	<b>VHome</b> setting does not match flow valve.	Immediately contact a certified Pulmonetic Systems' service technician.
PEEP not working. PEEP low. PEEP sags during exhalation.	Circuit leak.	Run a leak test and reseal or replace the leaking parts or connections. See page 11-8 for instructions.
	Diaphragm incorrectly seated in exhalation valve.  Diaphragm installed backwards.	Open the exhalation valve and remove the diaphragm. Reseat the diaphragm and snap the exhalation valve in place. See page 13-9 for a diagram of correct exhalation valve assembly.

<b>Symptoms</b>	<b>Possible Causes</b>	<b>What to Do</b>
<p><b>Continued...</b>  <i>PEEP not working.</i>  <i>PEEP low.</i>  <i>PEEP sags during exhalation.</i></p>	High side sense line or elbow at patient wye loose or leaking.	<p>Check high and low pressure sense lines to be sure they are correctly attached and securely seated at both the ventilator and wye ends.</p> <p>Check the luer fitting connections for leaks.</p> <p>Check the elbow connectors at the wye to be sure they have not loosened or been broken loose.</p> <p>Verify lines are not occluded or pinched.</p>
	Failed calibration or internal problem with the ventilator.	Immediately contact a certified Pulmonetic Systems' service technician.
<p>Ventilator won't trigger at sensitivity setting of 1 Lpm.</p>	Patient effort inadequate.	Some very small patients and patients with very weak inspiratory efforts may not be able to generate a 1 Lpm effort.
	Failed autozero.	Perform an autozero under <b>XD CR ZERO</b> . See page 10-27 for more information.
	Leak Compensation is not on.	Verify that the Leak Compensation extended features option is set to <b>On</b> (default setting is on). See page 10-12 for instructions.
	Failed calibration or internal problem with the ventilator.	Immediately contact a certified Pulmonetic Systems' service technician.
<p>Condensation in sense lines.</p>	High or low sense lines are occluded. High or low sense ports in the wye are occluded.	Verify lines are not occluded or pinched and/or clear the lines with a low flow (less than 10 lpm) gas source.
	Defective purge solenoids.	Immediately contact a certified Pulmonetic Systems' service technician.
<p>Ventilator is on, gas is not delivered and turbine is running.</p>	Failed calibration or internal problem with the ventilator.	Immediately contact a certified Pulmonetic Systems' service technician.
<p>Ventilator makes a high pitched noise when in Standby.</p>	Battery charge circuit running.	When the battery charge circuit is running in bulk charge (the <b>Charge Status</b> LED is amber) the ventilator may emit a high pitched sound that some people can hear. This is normal.

<b>Symptoms</b>	<b>Possible Causes</b>	<b>What to Do</b>
Ventilator gets excessively hot.	Patient circuit leaks. ventilator must run harder to maintain PEEP.	Perform a Leak Test and reseal or replace the leaking parts or connections. See page 11-8 for instructions.
	Internal problem with the ventilator.	Immediately contact a certified Pulmonetic Systems' service technician.
Ventilator does not work with LTM Graphics Monitor.	Communications setting is not set to <b>MONITOR</b> mode.	Set communications setting to <b>MONITOR</b> mode. See page 10-15 for instructions.
	Ventilator requires upgrades to be compatible with LTM Graphics Monitor.	Check LTM compatibility in the Model Number menu. See page 10-18 for instructions. If the ventilator is not LTM compatible, it will require upgrading by a certified Pulmonetic Systems' service technician to accommodate the LTM Graphics Monitor.
	Defective connections between the LTM Graphics Monitor and the ventilator.	Check the Communications Data Cable connection between the ventilator's communications port and the LTM Graphics Monitor's Data Port. See the LTM Graphics Monitor Operator's Manual, P/N 11010, for detailed instructions.

## Power and Battery Operation

Problem	Possible Causes	What To Do
The ventilator does not power up.	Faulty power connection, AC power source or adapter and depleted internal battery.	Verify the power cord for the AC adapter is fully seated. Connect the ventilator to a verified source of AC power. Allow the internal battery to charge a minimum of 8 hours.
	Internal problem with the ventilator.	Immediately contact a certified Pulmonetic Systems' service technician.
<b>Vent Inop</b> LED is on and ventilator is not ventilating.	Vent in Standby.	After the vent has been turned off and the external power is reconnected, the <b>Vent Inop</b> LED is lit. This is normal. Push the <b>On/Standby</b> button to turn ventilator on.
	Ventilator was running on internal battery and battery became depleted.	Connect the ventilator to a good external power source.
	<b>Vent Inop</b> .	Power up the vent and check the <b>EVENT TRACE</b> for events indicating the reason for inop. See page E-1 for information on reading the event trace.
	Internal problem with the ventilator.	Immediately contact a certified Pulmonetic Systems' service technician.
The ventilator doesn't operate from external power.	Defective AC source. AC adapter power cord loose.	Make sure the AC adapter is securely plugged into a verified source of AC power and is securely connected to the ventilator. Verify the power cord for the adapter is fully seated.
	Defective AC adapter.	Replace the AC adapter.
	Internal problem with the ventilator.	Immediately contact a certified Pulmonetic Systems' service technician.
The ventilator does not operate from internal battery. The ventilator shuts off when external power is removed.	Internal battery depleted.	If the internal battery is depleted, charge the internal battery for 8 hours by connecting the external AC adapter and plugging it into a good AC source.
	Internal problem with the ventilator.	Immediately contact a certified Pulmonetic Systems' service technician.

<b>Problem</b>	<b>Possible Causes</b>	<b>What To Do</b>
Battery doesn't reach full charge. Battery depletes too quickly.	Internal battery deeply discharged.	Charge the internal battery for 24 hours by connecting the external AC adapter and plugging it into a good AC source. If the battery is deeply discharged, it may take several cycles of charging and discharging for the battery to reach a maximum charge.
	Defective internal battery or internal problem with the ventilator.	Immediately contact a certified Pulmonetic Systems' service technician.
Battery <b>Charge Status</b> LED is flashing amber.	Internal battery charging.	The <b>Charge Status</b> LED flashes amber while the battery charging circuit evaluates the battery as a part of the charge cycle. If the battery is found to be OK, the <b>Charge Status</b> LED will change to solid amber while the battery is charging. The internal battery charges any time the ventilator is connected to an external power source. If the battery is deeply discharged, the <b>Charge Status</b> LED may flash amber for up to an hour.
	Defective internal battery or internal problem with the ventilator.	Immediately contact a certified Pulmonetic Systems' service technician.
Battery <b>Charge Status</b> LED is flashing red.	Defective internal battery or internal problem with the ventilator.	Immediately contact a certified Pulmonetic Systems' service technician.
Battery <b>Charge Status</b> LED is solid red.	Defective internal battery or internal problem with the ventilator.	Immediately contact a certified Pulmonetic Systems' service technician.

## Alarms

Many alarms such as **HIGH PRES** or **LOW O2 PRES** can occur during normal operation. Information on addressing alarms is covered in the Operator's Manual. Single occurrences of some alarms, such as **HW FAULT** or **RESET** may be caused by ESD. If these alarms reoccur, and for other alarms that do not usually occur during normal operation, follow the instructions in this section or immediately contact Pulmonetic Systems.

Symptoms	Possible Causes	What to Do
<b>HIGH PRES</b> occurred but alarm did not sound.	Alarm silence was already active ( <b>Silence Reset</b> LED is red).	The ventilator alarms can be silenced for 60 seconds by pushing the <b>Silence Reset</b> button. If the alarm is already silenced ( <b>Silence Reset</b> LED is red), it will not sound again until the silence period expires.
	High pressure alarm delay is on - <b>HP DELAY</b> is set to <b>DELAY 1 BRTH</b> or <b>DELAY 2 BRTH</b> .	When a high pressure condition is detected, the <b>HIGH PRES</b> message is displayed and the <b>High Pres. Limit</b> control is flashed. If the <b>HP DELAY</b> option is set to <b>NO DELAY</b> , the audible alarm is sounded immediately.  When the <b>HP DELAY</b> option is set to <b>DELAY 1 BRTH</b> or <b>DELAY 2 BRTH</b> , the audible is not sounded until the second or third consecutive breath with a high pressure condition. (See page 10-4 for an explanation of <b>HP DELAY</b> .)
	Alarm automatically silenced after 3 seconds because condition cleared.	When an alarm occurs, the audible alarms sound for a minimum of 3 seconds or for as long as the condition exists. Some alarms, such as <b>HIGH PRES</b> may clear almost immediately and the alarm will sound for only 3 seconds.
Alarm doesn't sound.	Internal problem with the ventilator.	Immediately contact a certified Pulmonetic Systems' service technician.
Ventilator won't exhale, repeated <b>HIGH PRES</b> alarms, turbine stops and pressure drops, then autocycles up to <b>HIGH PRES</b> again.	Diaphragm installed backwards or incorrectly seated in exhalation valve.	Open the exhalation valve and remove the diaphragm. Reseat the diaphragm and snap the exhalation valve in place. See page 13-9 for a diagram of correct exhalation valve assembly.

<b>Symptoms</b>	<b>Possible Causes</b>	<b>What to Do</b>
<b>continued...</b> <i>Ventilator won't exhale, repeated <b>HIGH PRES</b> alarms, turbine stops and pressure drops, then autcycles up to <b>HIGH PRES</b> again.</i>	Exhalation Drive line occluded or pinched.	Check the exhalation drive line to be sure it is correctly attached and secured at both the ventilator and exhalation valve ends. Verify the line is not occluded or pinched.
	Internal problem with the ventilator.	Immediately contact a certified Pulmonetic Systems' service technician.
Repeated <b>DISC/SENSE</b> alarms.	High or low side sense lines disconnected from vent or wye. High or low side sense line or elbow at patient wye loose or leaking. High or low sense lines are occluded. High or low sense ports in the wye are occluded.	Check high and low pressure sense lines to be sure they are correctly attached and securely seated at both the ventilator and wye ends. Check the luer fitting connections for leaks. Check the elbow connectors at the wye to be sure they have not loosened or been broken loose. Verify lines are not occluded or pinched. Check the exhalation drive line at both the ventilator and exhalation valve ends. Verify the line is securely seated and not leaking.
	Patient circuit disconnected at patient, ventilator or circuit component.	Check the circuit and exhalation valve to verify the circuit is securely connected and the valve is intact. Open the exhalation valve and remove the diaphragm. Reseat the diaphragm and snap the valve cap back in place. See page 13-9 for a diagram of correct exhalation valve assembly.

Symptoms	Possible Causes	What to Do
<b>continued...</b> <i>Repeated</i> <b>DISC/SENSE</b> alarms.	Exhalation drive line leaking or loose. Exhalation valve leaking during inspiration.	Check the exhalation drive line at both the ventilator and exhalation valve ends. Verify the line is securely seated and not leaking. Verify the exhalation valve is not leaking during inspiration. If it is leaking, open the exhalation valve and remove the diaphragm. Reseat the diaphragm. See page 13-9 for a diagram of correct exhalation valve assembly. If necessary, replace the exhalation diaphragm, or exhalation valve with a new one.
	Internal problem with the ventilator.	Immediately contact a certified Pulmonetic Systems' service technician.
Repeated <b>XDCR FAULT</b> alarms.	Internal problem with the ventilator.	Immediately contact a certified Pulmonetic Systems' service technician.
<b>HW FAULT</b> alarm	Electro static discharge (ESD).	Clear the alarm. Reduce static causing conditions in the operating environment.
	Fan was bumped or temporarily stopped while cleaning fan filter.	Clear the alarm. No further action required if alarm does not reoccur.
	Internal problem with the ventilator.	If problem reoccurs, immediately contact a certified Pulmonetic Systems' service technician.
<b>RESET</b> alarm occurs after ventilator is operated on internal battery until it is fully depleted.	Internal battery depleted.	This is a normal. Clear the alarm and charge the internal battery (see page 14-11 for instructions on charging the internal battery).
<b>RESET, CRC, STACK, POST, or RUNAWAY</b> alarms	Electro static discharge (ESD).	Clear the alarm. Reduce static causing conditions in the operating environment.
	Internal problem with the ventilator.	If problem reoccurs, immediately contact a certified Pulmonetic Systems' service technician.
<b>NO CAL DATA</b> alarm. <b>NO CAL</b> displayed in place of monitored values.	Failed or missing calibration records.	Immediately contact a certified Pulmonetic Systems' service technician.



Symptoms	Possible Causes	What to Do
<b>DEFAULTS</b> alarm. Event Log shows <b>DEFAULTS</b> .	Electro static discharge (ESD).	Some or all control settings were found to be invalid or out of range on power up and were restored to the default settings. Clear the alarm. Reduce static causing conditions in the operating environment.
	Internal problem with the ventilator.	If problem reoccurs, immediately contact a certified Pulmonetic Systems' service technician.
Repeated <b>HIGH f</b> alarms.	Total Breath Rate (f) exceeds the set <b>HIGH f</b> alarm values.	Check <b>HIGH f</b> alarm values. See page 10-5 for instructions.
	Patient Circuit leak, causing autocycling.	Do a Leak test and reseal or replace the leaking parts or connections. See page 11-8 for instructions.
	Internal problem with the ventilator.	If problem reoccurs, immediately contact a certified Pulmonetic Systems' service technician.
Repeated <b>HIGH PEEP</b> alarms.	Monitored PEEP exceeds the set <b>HIGH PEEP</b> alarm value.	Check <b>HIGH PEEP</b> alarm value. See page 10-5 for instructions.
	Patient circuit and/or Exhalation valve occluded.	Disassemble, clean and reassemble the Patient Circuit and Exhalation Valve. See page 13-9 for a diagram of correct exhalation valve assembly.
	Internal problem with the ventilator.	If problem reoccurs, immediately contact a certified Pulmonetic Systems' service technician.
Remote Alarm System does not work with the ventilator.	Defective or improper connections.	Check the Remote Alarm cable connection between the ventilator's Patient Assist Port and the Remote Alarm System. See page C-16 for instructions.
	Defective Remote Alarm cable.	Replace Remote Alarm cable. See page C-16 for instructions.
	Defective Remote Alarm System.	Contact Remote Alarm System manufacturer or service personnel.
	Internal problem with the ventilator.	Immediately contact a certified Pulmonetic Systems' service technician.
Remote Alarm System ( <i>single</i> tone system) generates a pulsating tone and manufacturers instructions indicate it should be a continuous tone.	PNT ASSIST option set to <b>PULSE</b> .	Set PNT ASSIST option to <b>NORMAL</b> . See page 10-6 for instructions.
	Defective Remote Alarm System.	Contact Remote Alarm System manufacturer or service personnel.
	Internal problem with the ventilator.	Immediately contact a certified Pulmonetic Systems' service technician.

Symptoms	Possible Causes	What to Do
Remote Alarm System ( <i>dual</i> tone system) only generates one continuous tone.	PNT ASSIST option set to <b>NORMAL</b> .	Set PNT ASSIST option to <b>PULSE</b> . See page 10-6 for instructions.
	Defective Remote Alarm System.	Contact Remote Alarm System manufacturer or service personnel.
	Internal problem with the ventilator.	Immediately contact a certified Pulmonetic Systems' service technician.
Patient Assist Call System does not work with the ventilator.	Incorrect Patient Assist cable installed (Normally Open versus Normally Closed system/cable mismatch)	Establish whether the Patient Assist Call System is a Normally Open or Normally Closed system and verify the appropriate Patient Assist Cable (Normally Open or Normally Closed) is installed. See page C-14 for instructions.
	Defective or improper connections.	Check the Patient Assist Cable connection between the ventilator's Patient Assist Port and the Patient Assist Call System. See page C-14 for instructions.
	Defective Patient Assist cable.	Replace Patient Assist Cable.
	Defective Patient Assist Call System.	Contact Patient Assist Call System manufacturer or service personnel.
	Internal problem with the ventilator.	Immediately contact a certified Pulmonetic Systems' service technician.
Patient Assist Call System generates a pulsating tone or light and manufacturers instructions indicate it should be a continuous tone or light.	PNT ASSIST option set to <b>PULSE</b> .	Set PNT ASSIST option to <b>NORMAL</b> . See page 10-6 for instructions.
	Defective Patient Assist Call System.	Contact Patient Assist Call System manufacturer or service personnel.
	Internal problem with the ventilator.	Immediately contact a certified Pulmonetic Systems' service technician.
Repeated <b>SBT &gt; f</b> alarms.	Total Breath Rate (f) exceeds the set <b>SBT &gt; f</b> alarm value.	Check <b>SBT &gt; f</b> alarm value. See page 10-26 for instructions.
	Patient Circuit leak, causing autocycling.	Do a Leak test and reseal or replace the leaking parts or connections. See page 11-8 for instructions.
	Internal problem with the ventilator.	If problem reoccurs, immediately contact a certified Pulmonetic Systems service technician.
Repeated <b>SBT &lt; f</b> alarms.	Total Breath Rate (f) is less than the set <b>SBT &lt; f</b> alarm value.	Check <b>SBT &lt; f</b> alarm value. See page 10-26 for instructions.
	Patient Circuit leak.	Do a Leak test and reseal or replace the leaking parts or connections. See page 11-8 for instructions.
	Internal problem with the ventilator.	If problem reoccurs, immediately contact a certified Pulmonetic Systems service technician.

<b>Symptoms</b>	<b>Possible Causes</b>	<b>What to Do</b>
Repeated <b>SBT &gt; f/Vt</b> alarms.	Total Breath Rate (f) exceeds the set <b>SBT &gt; f/Vt</b> alarm value.	Check <b>SBT &gt; f/Vt</b> alarm value. See page 10-26 for instructions.
	Patient Circuit leak.	Do a Leak test and reseal or replace the leaking parts or connections. See page 11-8 for instructions.
	Internal problem with the ventilator.	If problem reoccurs, immediately contact a certified Pulmonetic Systems service technician.
Repeated <b>SBT &lt; f/Vt</b> alarms.	Total Breath Rate (f) is less than the set <b>SBT &lt; f/Vt</b> alarm value.	Check <b>SBT &lt; f/Vt</b> alarm value. See page 10-26 for instructions.
	Patient Circuit leak.	Do a Leak test and reseal or replace the leaking parts or connections. See page 11-8 for instructions.
	Internal problem with the ventilator.	If problem reoccurs, immediately contact a certified Pulmonetic Systems service technician.

## Checkout Test Failures

Symptoms	Possible Causes	What to Do
<b>Alarm Test</b> Audible alarm level excessive.	Alarm volume set too high.	Set the alarm volume under the Extended Features Menu. (See page 10-3 for an explanation of the <b>ALARM VOL</b> feature.)
<b>Alarm Test</b> Audible alarm too soft.	Alarm volume set too low.	Set the alarm volume under the Extended Features Menu. (See page 10-3 for an explanation of the <b>ALARM VOL</b> feature.)
	Alarm sounder blocked.	Check the alarm sounder opening in the right side of the ventilator to verify the opening is not blocked.
	Internal problem with the ventilator.	Immediately contact a certified Pulmonetic Systems' service technician.
<b>Alarm Test</b> Alarm does not sound.	Alarm sounder blocked.	Check the alarm sounder opening in the right side of the ventilator to verify the opening is not blocked.
	Internal problem with the ventilator.	Immediately contact a certified Pulmonetic Systems' service technician.
<b>Alarm Test</b> Confirming audible chirp does not sound.	Audible alarm did not sound long enough before test was terminated.	Repeat the Alarm Test and allow audible alarm to sound for at least 2 seconds before pushing the <b>Select</b> button. (See <i>Alarm Test</i> in Chapter 11 for instructions.)
	Internal problem with the ventilator.	Immediately contact a certified Pulmonetic Systems' service technician.
<b>Display Test</b> A display or LED fails to light.	Internal problem with the ventilator.	Immediately contact a certified Pulmonetic Systems' service technician.
<b>Control Test</b> Correct message is not displayed when <b>Set Value</b> knob is turned, or incorrect message is displayed.	Internal problem with the ventilator.	Immediately contact a certified Pulmonetic Systems' service technician.
<b>Control Test</b> <b>Volume Pressure</b> Mode button, <b>Pres. Control</b> button, <b>O<sub>2</sub> % (O<sub>2</sub> Flush)</b> button, or <b>Low Pressure O<sub>2</sub> Source</b> button do not display message when pushed.	Wrong model selected in maintenance mode.	Immediately contact a certified Pulmonetic Systems' service technician.

Symptoms	Possible Causes	What to Do
<b>Leak Test</b> Leak test fails	Circuit connections or accessories are leaking. Wye is not properly capped.	Reseat or replace the leaking circuit parts, accessories or connections. Verify the wye is securely capped.
	Internal problem with the ventilator.	Immediately contact a certified Pulmonetic Systems' service technician.
<b>Leak Test</b> Leak test fails with <b>LEAK --- FAIL</b> message.	Internal problem with the turbine.	Immediately contact a certified Pulmonetic Systems' service technician.
<b>Vent Inop Alarm Test</b> Audible alarm too soft.	Alarm sounder blocked.	Check the alarm sounder opening in the right side of the ventilator to verify the opening is not blocked.
	Internal problem with the ventilator.	Immediately contact a certified Pulmonetic Systems' service technician.
<b>Vent Inop Alarm Test</b> Alarm does not sound.	Alarm sounder blocked.	Check the alarm sounder opening in the right side of the ventilator to verify the opening is not blocked.
	Internal problem with the ventilator.	Immediately contact a certified Pulmonetic Systems' service technician.
<b>Vent Inop Alarm Test</b> The <b>Vent Inop</b> LED is not illuminated.	Internal problem with the ventilator.	Immediately contact a certified Pulmonetic Systems' service technician.
<b>Vent Inop Alarm Test</b> Confirming audible chirp does not sound.	Audible alarm did not sound long enough before test was terminated.	Repeat the Vent Inop Alarm Test and allow audible alarm to sound for at least 15 seconds before pushing the <b>Silence Reset</b> button. (See <i>Chapter 11 - Vent Inop Alarm Test</i> for instructions.)
	Internal problem with the ventilator.	Immediately contact a certified Pulmonetic Systems' service technician.

## *Test Lung Operations*

---

<b>Symptoms</b>	<b>Possible Causes</b>	<b>What to Do</b>
Delivered pressure higher than set pressure on test lung.	Pressure > 40 cmH <sub>2</sub> O used on small test lung (Pulmonetic Systems or Siemens 190.)	The compliance characteristics of some small test lungs (Pulmonetic Systems or Siemens 190) cause incorrect readings when high pressures are used. For these lungs, use pressures under 40 cmH <sub>2</sub> O or change to a larger lung.
Monitored volumes very high on test lung.	Test lung with small aperture connected directly to wye.	Some test lungs have a narrow opening or a restrictor, which may cause jetting and cause the flow differential to be read incorrectly. To reduce the jetting effect, add a short extension between the test lung and the wye.
	Very small ET tube connected directly to wye.	A very small ET tube connected directly to the wye may cause jetting and cause the flow differential to be read incorrectly. To reduce the jetting effect, add a short larger bore extension between the ET tube and the wye.



## *Appendix A - VENTILATOR SPECIFICATIONS*

### **Modes and Breath Types**

Breath Types	Volume Control, Pressure Control, Pressure Support, Spontaneous
Modes	Control, Assist/Control, SIMV, CPAP, NPPV, Apnea Backup

### **Variable Controls**

<b>Control</b>	<b>Range</b>	<b>Tolerance</b>
Backup Pressure Trigger	-3 cmH <sub>2</sub> O	± 2 cmH <sub>2</sub> O
Breath Rate	"--", 1 to 80 bpm	± 1 bpm or 10% of breath period, whichever is less
Date Format	mm/dd/yyyy, dd/mm/yyyy, yyyy/mm/dd	n/a
Display Select	Toggles between manual or automatic display scrolling and changes monitor displayed.	n/a
Inspiratory/Expiratory Hold	One push toggles monitor window display between normal display, INSP HOLD and EXP HOLD.	
	While INSP HOLD is displayed, a push and hold initiates an Inspiratory Hold.	6 seconds maximum
	While EXP HOLD is displayed, a push and hold initiates an Expiratory Hold.	6 seconds maximum
Inspiratory Time	0.3 to 9.9 seconds	± 0.05 seconds
Leak Compensation	On, Off	n/a
Language	English, Dansk, Deutsch, Español, Francais, Italiano, Norsk, Portugues, Svenska, Pyccko	n/a
O <sub>2</sub> %	21% to 100%	O <sub>2</sub> % mean: 21% to 50%: ± 3 51% to 100%: ± 5 keep steady-state only
(O <sub>2</sub> Flush)	O <sub>2</sub> : 95%	± 5
	Time: 1, 2, or 3 minutes	± 0.1 sec
Patient Query	On, Off	n/a



<b>Control</b>	<b>Range</b>	<b>Tolerance</b>
PEEP/CPAP	0 to 20 cmH <sub>2</sub> O	Uncalibrated
PIP LED Display	On, Off	n/a
Pressure Control	1 to 99 cmH <sub>2</sub> O	± 2 cmH <sub>2</sub> O or 8% whichever is greater, steady-state only
Pressure Control Flow Termination	On, Off	n/a
Pressure Support	"--", 1 to 60 cmH <sub>2</sub> O	± 2 cmH <sub>2</sub> O or 8% whichever is greater, steady-state only.
Set Date	01/01/1998 to 12/31/2097	n/a
Set Time	00:00:00 to 23:59:59	n/a
Sensitivity	1 to 9 Lpm, "-"	+ 1/- 0.5 lpm for setting of 1; ± 1 lpm for all other settings.
Tidal Volume	50 to 2000 ml	± 10% or 10 ml, whichever is greater for temperatures from 20°C to 30°C only, standard atmospheric pressure
Variable Flow Termination	10% to 40%	± 15% or 2 lpm whichever is greater
Variable Rise Time	1 to 9	0.1 to 1.0 sec
Variable Time Termination	0.3 to 3.0 sec	± 0.1 sec
Bias Flow	10 lpm during exhalation	± 10% or 1 lpm, whichever is greater
SBT Start	On - Off	n/a
SBT PS	0-30 cmH <sub>2</sub> O	± 2 cmH <sub>2</sub> O or 8% whichever is greater, steady-state only.
SBT PEEP	0-20 cmH <sub>2</sub> O	± 2 cmH <sub>2</sub> O or 10%, whichever is greater
SBT FIO <sub>2</sub>	21-100%	O <sub>2</sub> % mean: 21% to 50%: ± 3 51% to 100%: ± 5 keep steady-state only
SBT O <sub>2</sub> minutes	15-120 minutes	n/a
SBT high f/Vt	70-120	± 20%
SBT low f/Vt	5-90	± 20%
SBT High f	15-80 BPM	± 1 bpm or within 5%, whichever is greater
SBT Low f	0-40 BPM	± 1 bpm or within 5%, whichever is greater
Display f/Vt	On - Off	n/a

## Alarms

### Variable Alarms

<b>Control</b>	<b>Range</b>	<b>Tolerance</b>
Apnea Interval	10 to 60 seconds	± 0.5 seconds
High Breath Rate	Rate: 5 - 80 bpm - HIGH f OFF Time: 0 - 60 sec	± 1 bpm or within 5% of breath period, whichever is greater. ± 0.1 seconds
High PEEP	3 to 20 cmH <sub>2</sub> O above set PEEP	± 2 cmH <sub>2</sub> O or ± 10%, whichever is greater.
Low PEEP	-3 to - 20 cmH <sub>2</sub> O below set PEEP	± 2 cmH <sub>2</sub> O or ± 10%, whichever is greater.
High Pressure Limit	5 to 100 cmH <sub>2</sub> O	5 to 20 cmH <sub>2</sub> O: ± 2 cmH <sub>2</sub> O 21 to 100 cmH <sub>2</sub> O: ± 4 cmH <sub>2</sub> O
HP Alarm Delay	No Delay, 1 Breath, 2 Breaths	Only audible portion of alarm notification is delayed.
Low Minute Volume	0.1 to 99 liters	± 15% or the measured total breath rate times 15 ml, whichever is greater.
Low Peak Pressure	"- -", 1 to 60 cmH <sub>2</sub> O	2 to 20 cmH <sub>2</sub> O: ± 2 cmH <sub>2</sub> O 21 to 60 cmH <sub>2</sub> O: ± 4 cmH <sub>2</sub> O
LPP Alarm	All Breaths, VC/PC Only	Select breath types Low Pressure alarm applies to.
SBT High f/Vt	Off, 70 – 900 f/Vt	± 2 cmH <sub>2</sub> O or 10%, whichever is greater
SBT Low f/Vt	Off, 5 – 90 f/Vt	± 2%
SBT High f	Off, 15 – 80 bpm	± 1 bpm or within 5% of the breath period, whichever is greater
SBT Low f	Off, 1 – 40 bpm	± 1 bpm or within 5% of the breath period, whichever is greater

### Fixed Alarms

Control	Range	Tolerance / Indicators	
Default Settings	EEPROM problem detected	n/a	
DISC/SENSE (Low Pressure Sense Line Disconnect)	Positive (exhaled) airway flow during first 200 ms of inspiration and exhaled tidal volume (Vte) of previous breath is more than 4000 ml	n/a	
DISC/SENSE (High Pressure Sense Line Disconnect)	Airway pressure changes by $\leq 1$ cmH <sub>2</sub> O during 200 ms after inspiratory start OR After initial 200 ms of inspiration airway pressure drops below 0.125 cmH <sub>2</sub> O and can't be raised more than 0.5 cmH <sub>2</sub> O in next 500 ms	$\pm 0.5$ cmH <sub>2</sub> O  n/a	
External Power Lost	<9.5 V	$\pm 2\%$	
Hardware Fault	Hardware problem detected	n/a	
Internal Battery Empty	< 11.5 V	$\pm 2\%$	<b>Battery Level</b> LED Red and full volume audible alarm.
Internal Battery Low	< 11.9 V	$\pm 2\%$	<b>Battery Level</b> LED Amber
Oxygen Inlet Pres. High	High pres source: 85 PSIG Low pres source: 10 PSIG	$\pm 2$ PSIG $\pm 1$ PSIG	
Oxygen Inlet Pres. Low	< 35 PSIG	$\pm 2$ PSIG	
Reset	Processor problem detected	n/a	
Transducer Fault	Autozero value outside manufacturer's specifications	n/a	
SBT Off	End of an SBT period	n/a	
SBT Time	Two minutes remaining in an SBT period	n/a	

### Volume

Alarm Volume	60 to 85 dBA at one meter	$\pm 5$ dBA
--------------	---------------------------	-------------

### Inop

Ventilator Inop	Immediately upon a Ventilator <b>INOP</b> condition, the audible indicator will begin sounding with a steady tone and the <b>Vent Inop</b> LED shall illuminate. Depressing the alarm <b>Silence Reset</b> button will silence the audible indicator.	
-----------------	---	--

### **Mechanical Controls**

<b>Control</b>	<b>Range</b>	<b>Tolerance</b>
Over Pressure Relief	≤120 cmH <sub>2</sub> O	N/A
Sub-Ambient Relief	Pressure Drop: ≤ 5 cmH <sub>2</sub> O	at 50 lpm

### **Internal Compliance**

Compliance	< 0.1 mL/cm
------------	-------------

### **Monitors**

<b>Monitor</b>	<b>Range</b>	<b>Tolerance</b>
Calculated Peak Flow	10 to 100 lpm	2 lpm or ± 10%, whichever is greater
Exhaled Tidal Volume	0 to 4000 ml	± 15% or 15 ml, whichever is greater
I:E Ratio, Measured	99:1 and 1:99 Based on the measured inspiratory / exhalation times	Accuracy for times are ± 50 ms or 5%, whichever is greater
I:E Ratio, Calculated	1:99 to 4.0:1 based on set breath rate and inspiratory time	± 5%
Mean Airway Pressure	0 to 99 cmH <sub>2</sub> O	± 2 cmH <sub>2</sub> O or 10%, whichever is greater
O <sub>2</sub> Cylinder Duration	0 - 99 hours and 59 minutes	- 0 / + 40%
Peak Inspiratory Pressure	0 to 120 cmH <sub>2</sub> O	± 2 cmH <sub>2</sub> O or 5%, whichever is greater
PEEP	0 to 99 cmH <sub>2</sub> O	± 2 cmH <sub>2</sub> O or 10%, whichever is greater
Total Breath Rate	0 to 250 breaths per minute	± 1 bpm or within 5% of the breath period, whichever is greater
Total Minute Volume	0 to 99.9 liters	± 15%, or the measured total breath rate times 15 ml, whichever is greater
SBT Minutes	15 – 120 minutes	± 0.1 seconds
f/Vt and f	0 – 4000  0 – 250bpm	± 20%  Total breath rate: ± 1 bpm or within 5% of breath period, whichever is greater

### **Button Controls**

<b>Display</b>	<b>Function</b>
Control Lock	Locks front panel controls, can be set to Easy or Hard unlocking
Manual Breath	Generates a machine breath
Standby/On	Puts ventilator in On or Standby state
Low Pressure O <sub>2</sub> Source	Selects Low Pressure O <sub>2</sub> Source
Silence Reset	Silences and resets alarms

## Displays

<b>Display</b>	<b>Range</b>	<b>Tolerance</b>
Airway Pressure	-10 to 108 cmH <sub>2</sub> O	± 3 cmH <sub>2</sub> O or 5%, whichever is greater
Display Window	12 characters	n/a
Patient Effort	Green LED	n/a
Vent Inop	Red LED	n/a
External Power	Amber / Green LED	n/a
Charge Status	Red / Amber / Green LED	n/a
Battery Level	Red / Amber / Green LED	n/a

### **Usage Meter**

Usage Meter	1 to 139,000 hrs	Below 100 hrs: ± 10%	Above 100 hrs: ± 5%
-------------	------------------	----------------------	---------------------

## Packaging

Size	3" x 10" x 12" -OR- 3.25" x 10.5" x 13.5" with Protective Boots installed.
Weight	13.4 lbs -OR- 14.4 lbs with Protective Boots installed.

## Sound Level

Sound Level	Shall not exceed 50 dBA (RMS) at one meter
-------------	--

## Storage and Operating Conditions

<b>Specification</b>	<b>Tolerance</b>	
<b>Storage<sup>61</sup></b>		
Temperature	-20 to +60 degrees C	n/a
Humidity	10% to 95% Relative, non-condensing	n/a
<b>Operating</b>		
Temperature	+5 to +40 degrees C	n/a
Humidity	15% to 95% Relative, non-condensing	n/a
<b>Orientation</b>		
The ventilator functions within its performance specifications when operated in any orientation.		
<b>Inlet Air Filtration</b>		
The ventilator air filter is removable and cleanable by the operator. All filter materials are FDA compliant for breathing circuits and meet burn requirements for UL 94HB.		

<sup>61</sup> LTV<sup>®</sup> ventilators stored at temperatures outside of the specified Operating Temperature range are to be allowed to stabilize to within the operating temperature range before turning the ventilator on.

## Storage and Operating Conditions (cont.)

<b>Specification</b>	<b>Tolerance</b>
<b>Oxygen Inlet</b>	
DISS or NIST Connector Inlet Pressure Range	40 to 80 PSIG ± 2 PSIG
Tapered Tubing Connector Inlet Pressure Range	0 to 10 PSIG ± 2 PSIG
<b>Shock and Vibration</b>	
The ventilator is designed to withstand shock and vibration in accordance with relevant requirements set forth in the following standards:	
IEC 68-2-27	Shock
IEC 68-2-6	Vibration
IEC 68-2-34	Vibration
MIL-STD-810E	Shock, Ground Transport and Helicopter Transport Vibration
<b>Spillage</b>	
The ventilator resists fluid spillage when tested in accordance with the relevant standards specified in IEC 601-1 Clause 44.3.	
<b>External Surface Temperature</b>	
External surfaces	< 50°C, ambient temperature of 35°C n/a

## Communications

<b>Port</b>	<b>Connector</b>	<b>Specification</b>
Communications	RS232, DB9 connector	Protocol Options: Data, Monitor, Printer, Modem
Patient Assist Call / Remote Alarm	RJ11-4	Closed contact resistance: ≤ 1 ohm

## Equipment Classification

Classification	The ventilator is rated as Class II equipment per IEC 601-1 Clause 6.11
Type	The ventilator is specified as Type BF equipment per IEC 601-1 Clause 6.11

**Power**

<b>Feature</b>	<b>Range</b>	<b>Tolerance / Indicators</b>	
Input Voltage	11 to 15 VDC		
<b>External Power</b>			
AC Adapter	Input: 90 to 250 VAC, 47 to 63 Hz Output: 12.8 VDC	± 2.5%	
Full Power	Voltage ≥ 11.5 V	± 2%	Green LED
Low Power	Voltage < 11.0V and ≥ 9.5V	± 2%	Amber LED
External Power Off	Voltage < 9.5V	± 2%	LED off, switch to battery
Hysteresis	Ventilator shall not resume external power operation unless voltage is 11.5V	± 2%	
Nominal Current Draw	Startup: 5.5 amps Running: 3-4 amps		
Nominal Power Draw	Startup: 66 watts Running: 36 - 48 watts		
Leakage Current	Total leakage current to Earth ground for the ventilator with only approved accessories attached, shall not exceed 500 microAmps during normal operation, per IEC 601-1. Total leakage current to Earth ground for the ventilator shall not exceed one milliAmp when any single fault condition is present, per IEC 601-1.		
Ground Resistance	Total impedance between the ground contact at the inlet power connector and any accessible metal part shall not exceed 0.1 ohm, per IEC 601-1.		
Dielectric Strength	The ventilator shall be able to survive 1500 volts applied from either phase of the AC power inlet to Earth ground for a period of one minute, per IEC 601-1.		

## Power (cont.)

### Internal Battery

12V sealed lead acid battery. 4.5Ah.

Feature	Range	Tolerance / Indicators
Full Power	Green LED	
Medium Power	Amber LED	
Low Power	Red LED	
Charge Time	Battery shall be capable of being >90% charged within 8 hours, from fully discharged state to state indicated by green <b>Charge Status</b> LED.	When external power is present, and the vent is running at the nominal load
Charge Status	Pre-Charge Qualification: Battery Charging: Battery >90% Charged: Battery Fault:	Flashing Amber LED Amber LED Green LED Red LED
Hysteresis	Ventilator shall not resume battery operation unless the battery voltage level is 11.8 V.	± 2%

<b>Battery Duration Time Before Ventilator Shutdown (total time):</b>	<b>60 minutes*</b>	<b>Nominal Load Settings:</b>	
Approximate Time from battery full (green LED) to battery low (amber LED and <b>BAT LOW</b> alarm):	45 minutes*	Mode	A/C
Approximate Time from battery low to battery empty (red LED and <b>BAT EMPTY</b> alarm):	10 minutes*	PEEP	5
Approximate Time from battery empty to "ventilator shutdown" ( <b>Vent Inop</b> LED and <b>INOP</b> alarm):	5 minutes*	Breath Rate (bpm)	15
		O <sub>2</sub> %	21
		Tidal Volume (ml)	800
		Lung Compliance (ml/cmH <sub>2</sub> O)	50
		Insp. Time (sec)	1.5
		ET Resistance (cmH <sub>2</sub> O/L/S)	5.87
		Sensitivity (lpm)	2
		Battery Temp.	25 °C
<b>* Times based on nominal load, new battery and full 8 hour battery charge.</b>			
<b>DOT Requirements:</b> Unregulated, meets the requirements of 49 CFR 173, 159 (d).			

## Agency Requirements

### Regulatory Requirements

FDA Draft Reviewer Guidance for Ventilators, July, 1995.

### Shipping Requirements

The ventilator, packed in its shipping container, conforms to the International Safe Transit Association requirements for packaged products weighing less than 100 pounds.





## Appendix B - SET UP / MAINTENANCE

### Recommended Maintenance Schedule

The LTV<sup>®</sup> 1200 ventilator is designed to operate for extended periods of time with minimal routine maintenance. The following periodic maintenance is recommended:

Hours of Service <sup>62</sup>	Maintenance Required
Prior to initial use	<ul style="list-style-type: none"> <li>• Charge the Internal Battery by plugging the ventilator into an AC power source for 24 hours.</li> <li>• Setup the ventilator/accessories per <i>Appendix C - Installation and Checkout</i>.</li> <li>• Check the ventilator for proper operation per <i>Appendix C - Installation and Checkout</i></li> </ul>
While in storage, every two months	<ul style="list-style-type: none"> <li>• Recharge the Internal Battery by plugging the ventilator into an AC power source for 24 hours<sup>63</sup>.</li> </ul>
Daily	<ul style="list-style-type: none"> <li>• Check the Inlet Filter, clean if necessary.</li> <li>• Check the Fan Filter, clean if necessary.</li> </ul>
If in use, a minimum of once a month	<ul style="list-style-type: none"> <li>• Check the ventilator per <i>Chapter 11 - Ventilator Checkout Tests</i>. While the ventilator is off-patient, perform the Power (external) disconnect test*</li> <li>• Verify Vte or VE monitor *</li> <li>• Verify airway pressure or PIP monitor *</li> <li>• Verify delivered O<sub>2</sub> concentration if not using an oxygen analyzer continuously, See <i>Appendix A - Ventilator Specifications</i> for accuracy tolerances.</li> </ul> <p style="margin-left: 20px;">* Use existing patient settings or example settings as shown in <i>Appendix C - Installation and Checkout</i></p>
Every 10,000 hours or two years <sup>64</sup>	<ul style="list-style-type: none"> <li>• Replace the Internal Battery<sup>65</sup> only with Pulmonetic Systems battery P/N 10140<sup>66</sup></li> <li>• Calibrate the Transducers.</li> <li>• Replace the Motor Board.</li> <li>• Clean or replace the Interior Air Inlet Filter.</li> <li>• Clean or replace the O<sub>2</sub> Inlet Filter.</li> </ul>
Every 30,000 hours or six years, whichever comes first <sup>64</sup>	<ul style="list-style-type: none"> <li>• Replace the Turbine Manifold Assembly.</li> <li>• Replace the Solenoid Manifold.</li> <li>• Replace the Flow Valve.</li> <li>• Replace the Rotary Switch Assembly.</li> <li>• Replace the O<sub>2</sub> Blender.</li> <li>• Replace the Fan Assembly.</li> <li>• Replace all Silicone Tubing.</li> <li>• Check the Thermo Pads for compression and replace if necessary.</li> </ul>

<sup>62</sup> To check the number of hours the ventilator has been in service, see *Chapter 10 - Extended Features, Usage Meter*.

<sup>63</sup> If the battery is deeply discharged, it may take several charge and discharge cycles before it can be fully charged.

<sup>64</sup> 10,000 hour, two year and/or 30,000 hour, six year Extended Maintenance and ventilator repair must be performed by a Pulmonetic Systems factory trained service technician.

<sup>65</sup> Replacement at 10,000 hours or 2 years is based on normal use of up to 200 charge cycles. The battery may need to be replaced more frequently if it is being charged more often. The battery should also be replaced any time it fails to reach a full charge, or if the ventilator runs for less than ½ hour on a fully charged battery.

<sup>66</sup> The LTV<sup>®</sup> Internal Battery (P/N 10140) is contained in LTV<sup>®</sup> Internal Battery Replacement Kit, P/N 11636.

## *Service Assistance*

---

For assistance in servicing the LTV<sup>®</sup> 1200 ventilator, contact a certified Pulmonetic Systems' service technician, or:

---

### **Pulmonetic Systems, Inc.**

---

17400 Medina Rd., Suite 100

Minneapolis, Minnesota 55447-1341

Phone: (763) 398-8300

Customer Care Center: (800) 754-1914

Fax: (763) 398-8400

E-mail: [info@pulmonetic.com](mailto:info@pulmonetic.com)

Website: <http://www.pulmonetic.com>

## *Appendix C - INSTALLATION AND CHECKOUT*

### *Installation and Setup*

---

#### *Unpacking the Ventilator – Instructions*

---

- 1) Inspect the exterior of the ventilator transport container for evidence of damage during transit. If present, notify the delivering service.
- 2) Take the ventilator and all accessories out of the transport container.
- 3) Confirm the presence of all items listed on the packing slip. Notify a authorized sales representative or Pulmonetic Systems of any discrepancies.
- 4) Examine all components for visible damage. If present, notify the delivering service.
- 5) Retain the transport container for potential ventilator service or maintenance returns.

## Protective Boots

---

Rubberized protective boots are installed on the top and bottom of all current versions of LTV<sup>®</sup> ventilators to protect them from accidental shocks and strikes to the casing. If desired, they may be removed and/or re-installed using the following instructions.

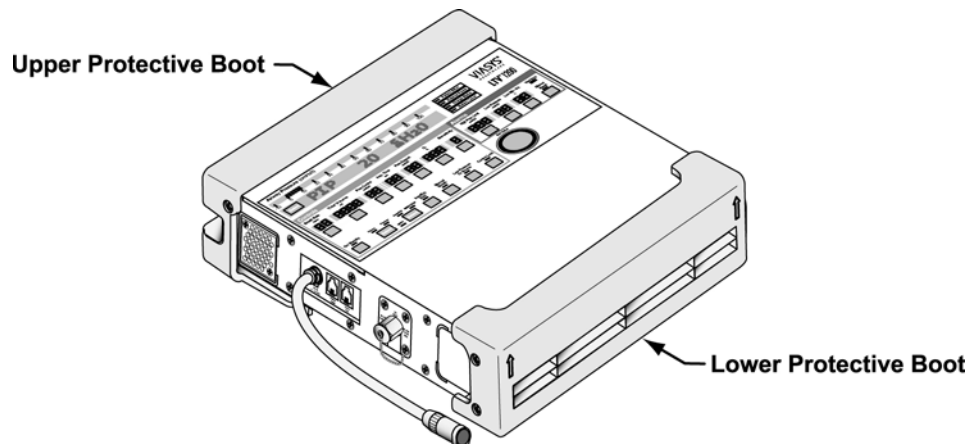

### **WARNING**

**Mounting Screw Use** – Internal damage to the ventilator may result if the wrong length mounting screws are used when installing or removing external accessories.

**Accessories Mounting Screws** - Refer to the information contained in Pulmonetic Systems Replacement Screws Kit, P/N 11149, to determine the appropriate mounting screws or replacement screws location, type and length to use when removing or exchanging external accessories on an LTV<sup>®</sup> ventilator.

### **AVERTISSEMENT**

**Utilisation des vis de montage** – Vous pourriez causer des dommages internes au ventilateur si des vis de montage de mauvaise longueur sont utilisées lors de l'installation ou de la dépose des accessoires externes.

**Vis de montage des accessoires** – Voir les renseignements fournis dans la trousse de vis de remplacement de Pulmonetic Systems, numéro de pièce 11149, pour déterminer l'emplacement, le type et la longueur des vis de montage d'accessoires ou des vis de remplacement pour accessoires à utiliser lors de la dépose ou de l'échange d'accessoires externes sur un ventilateur de la série LTV<sup>®</sup>.

## Protective Boot Removal

---

### Supplies/Tools Required:

- Replacement Screws Kit, P/N 11149
- Torque wrench (20 in-oz / 0.14 Nm to 60 in-oz / 0.42 Nm range)
- Phillips-head screwdriver

### To Remove the Upper Protective Boot<sup>67</sup>:

- 1) Carefully place and support the disconnected ventilator in an upright position on a clean, dry surface.
- 2) **Prior to removing the mounting screws**, refer to the illustration and make note of where the screw is located in the leg of the upper boot (upper or lower hole).

### **WARNING**

**Specific Boot Replacement Screw Location** - One leg of the upper protective boot has an additional screw hole (furthest from the end of the leg);

- On earlier version ventilators (screw was located in the upper hole in the leg of the boot) the use of a 3/16" mounting screw is required.
- On current version ventilators (screw was located in the lower hole in the leg of the boot) the use of a 1/4" mounting screw is required.

### **AVERTISSEMENT**

**Emplacement des vis de remplacement d'un gaine spécifique** – Une patte de la gaine protectrice supérieure possède un trou de vis supplémentaire (le plus éloigné de l'extrémité de la patte);

- Sur les anciennes versions des ventilateurs (la vis se trouvait dans le trou supérieur de la patte de la gaine), vous devez utiliser une vis de montage de 3/16".
- Sur la version actuelle des ventilateurs (la vis se trouve dans le trou inférieur de la patte de la gaine), vous devez utiliser une vis de montage de 1/4".

- 3) Using a Phillips screwdriver, remove the two flat-head mounting screws and finish washers in the legs of the upper boot (1) and the two flat-head mounting screws and finish washers in the sides of the upper boot, as indicated in the illustration on the next page.
- 4) Remove the upper boot and insert and thread two #4-40 pan-head mounting screws into the screw holes in the ventilator's back panel, as indicated in the illustration.
  - Earlier version ventilators (screw was aligned with the upper hole in the boot) require the use of the 3/16" pan-head mounting screw (3).
  - Current version ventilators (screw was aligned with the lower hole in the boot) require the use of the 1/4" pan-head mounting screw (4).

---

<sup>67</sup> Refer to *Appendix C - Installation and Checkout* for information concerning the appropriate accessories mounting screws or accessories replacement screws location, type and length to use when removing or exchanging external accessories on an LTV<sup>®</sup> ventilator.

- 5) Insert and thread two #4-40 X 1/4" flat-head mounting screws (5) with finish washers (6) into the screw holes in the ventilator's side panels, as indicated in the illustration.
  - Finish washers (6) should be already in place.
- 6) Torque tighten the mounting screws to these specified values (do not over tighten to avoid damage to the finish washers);
  - Torque tighten the screws in the back panel of the ventilator to **60 in-oz** (0.42 Nm)
  - Torque tighten the screws in the sides of the ventilator to **20 in-oz** (0.14 Nm)

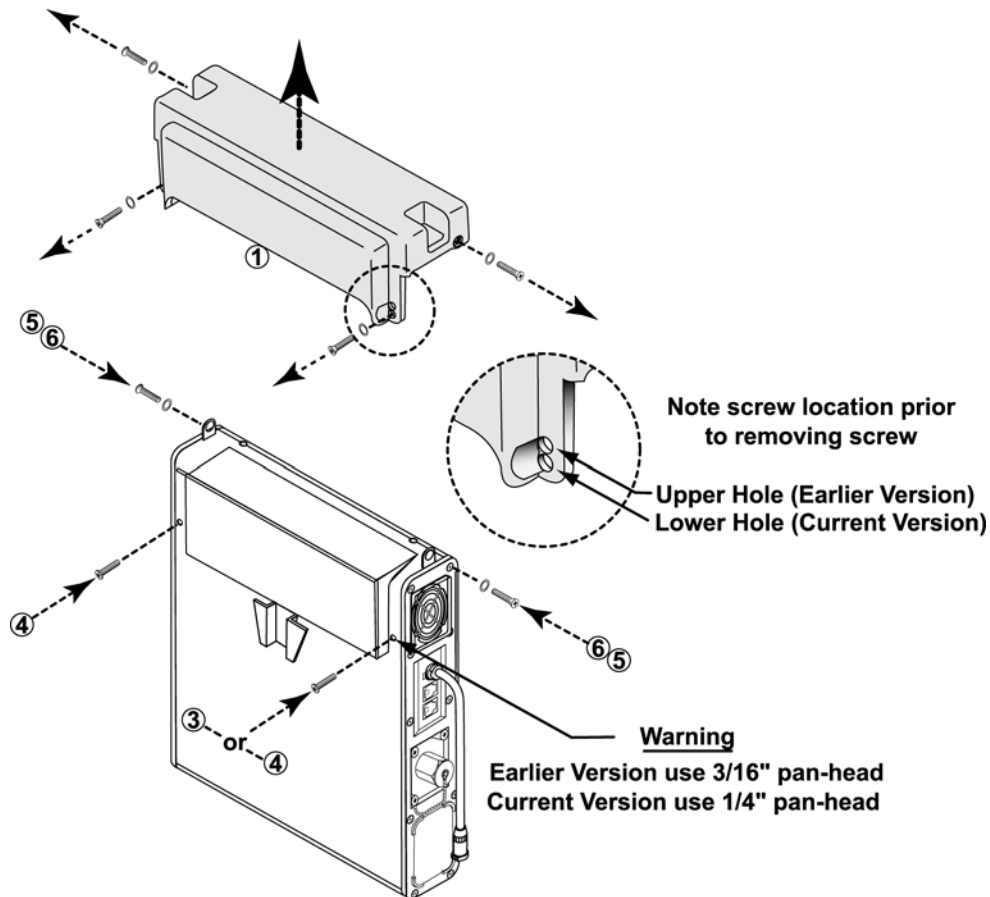

- Item (1), Protective Boot, Upper (1), P/N 11421
- Item (2), Protective Boot, Lower (1), P/N 11420
- Item (3), #4-40 X 3/16" Pan-head screw (1), P/N 10438<sup>68</sup>
- Item (4), #4-40 X 1/4" Pan-head mounting screws (2), P/N 10435<sup>68</sup>
- Item (5), #4-40 X 1/4" Flat-head mounting screws (6), P/N 10430<sup>68</sup>
- Item (6), Finish Washers (6), P/N 10191<sup>68</sup>

<sup>68</sup> Contained in Pulmonetic Systems Replacement Screws kit, P/N 11149.

### To Remove the Lower Protective Boot<sup>69</sup>:

- 1) Lay the ventilator down (front up) and use a Phillips-head screwdriver to remove the four flat-head mounting screws and finish washers in the sides of the lower protective boot (2), as indicated in the illustration.
- 2) Remove the lower boot (2) and insert and thread four #4-40 X 1/4" flat-head mounting screws (5) with finish washers (6) into the screw holes in the ventilator's side panels, as indicated in the illustration.
  - Finish washers (6) should be already in place.
- 3) Torque tighten all four screws to **20 in-oz** (0.14 Nm) (do not over tighten to avoid damage to the finish washers).

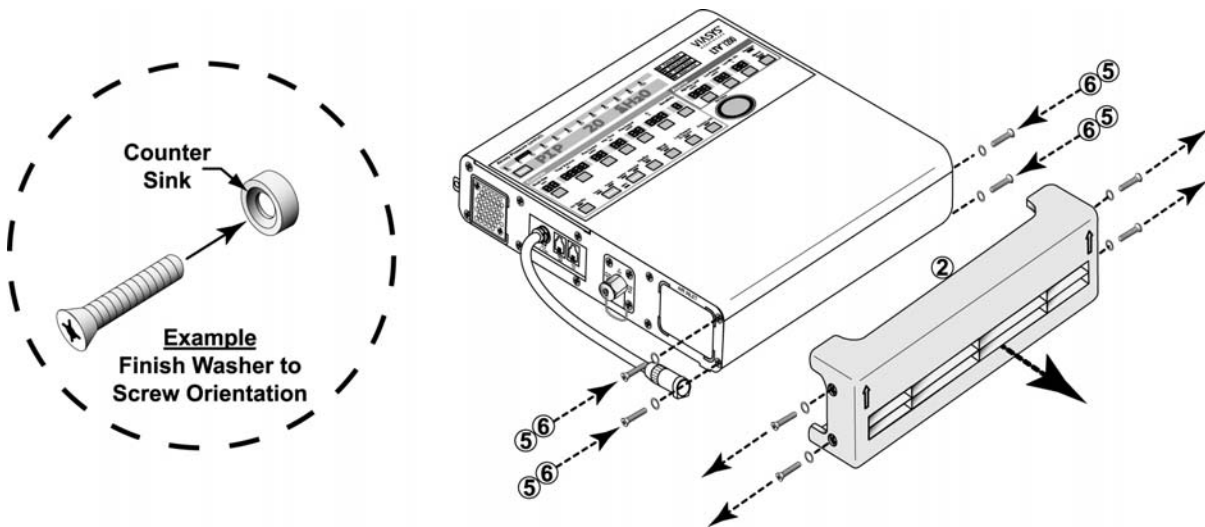

- Item (1), Protective Boot, Upper (1), P/N 11421
- Item (2), Protective Boot, Lower (1), P/N 11420
- Item (3), #4-40 X 3/16" Pan-head screw (1), P/N 10438<sup>70</sup>
- Item (4), #4-40 X 1/4" Pan-head mounting screws (2), P/N 10435<sup>68</sup>
- Item (5), #4-40 X 1/4" Flat-head mounting screws (6), P/N 10430<sup>68</sup>
- Item (6), Finish Washers (6), P/N 10191<sup>68</sup>

<sup>69</sup> Refer to *Appendix C - Installation and Checkout* for information concerning the appropriate accessories mounting screws or accessories replacement screws location, type and length to use when removing or exchanging external accessories on an LTV<sup>®</sup> ventilator.

<sup>70</sup> Contained in Pulmonetic Systems Replacement Screws kit, P/N 11149.



## Protective Boot Installation

---

### Supplies/Tools Required:

- Item (1), Protective Boot, Upper (1) P/N 11421
- Item (2), Protective Boot, Lower (1) P/N 11420
- Replacement Screws Kit, P/N 11149
- Torque wrench (20 in-oz / 0.14 Nm to 60 in-oz / 0.42 Nm range)
- Phillips-head screwdriver

### To Install the Upper Protective Boot<sup>71</sup>:

- 1) Carefully place and support the disconnected ventilator in an upright position on a clean, dry surface.
- 2) Using a Phillips-head screwdriver, remove the two upper back panel pan-head and two side panel flat-head mounting screws indicated in the illustration.
  - Do not remove the mating finish washers.
- 3) Orient the upper protective boot (1) over the ventilator as shown in the illustration (next page). Move the boot down into position on the top of the ventilator and align its four screw holes with the corresponding holes in the ventilator back and side panels.
- 4) Insert and thread two #4-40 flat-head mounting screws with finish washers (6) through the screw holes in the legs of the upper boot, as indicated in the illustration (next page).

### **WARNING**

**Specific Boot Installation Screw Location** - One leg of the upper protective boot has an additional screw hole (furthest from the end of the leg);

- On earlier version ventilators, the screw hole will align with the upper hole in the boot and requires the use of the 1/4" mounting screw.
- On current version ventilators, the screw hole will align with the lower hole in the boot and requires the use of the 3/8" mounting screw.

### **AVERTISSEMENT**

**Emplacement des vis d'installation d'un gaine spécifique** – Une patte de la gaine protectrice supérieure possède un trou de vis supplémentaire (le plus éloigné de l'extrémité de la patte);

- Sur les anciennes versions des ventilateurs, le trou de la vis s'alignera au trou supérieur de la gaine et vous devez utiliser une vis de montage de 1/4".
- Sur la version actuelle des ventilateurs, le trou de la vis s'alignera au trou inférieur de la gaine et vous devez utiliser une vis de montage de 3/8".

---

<sup>71</sup> Refer to page C-9 for information concerning the appropriate accessories mounting screws or accessories replacement screws location, type and length to use when removing or exchanging external accessories on an LTV<sup>®</sup> ventilator.

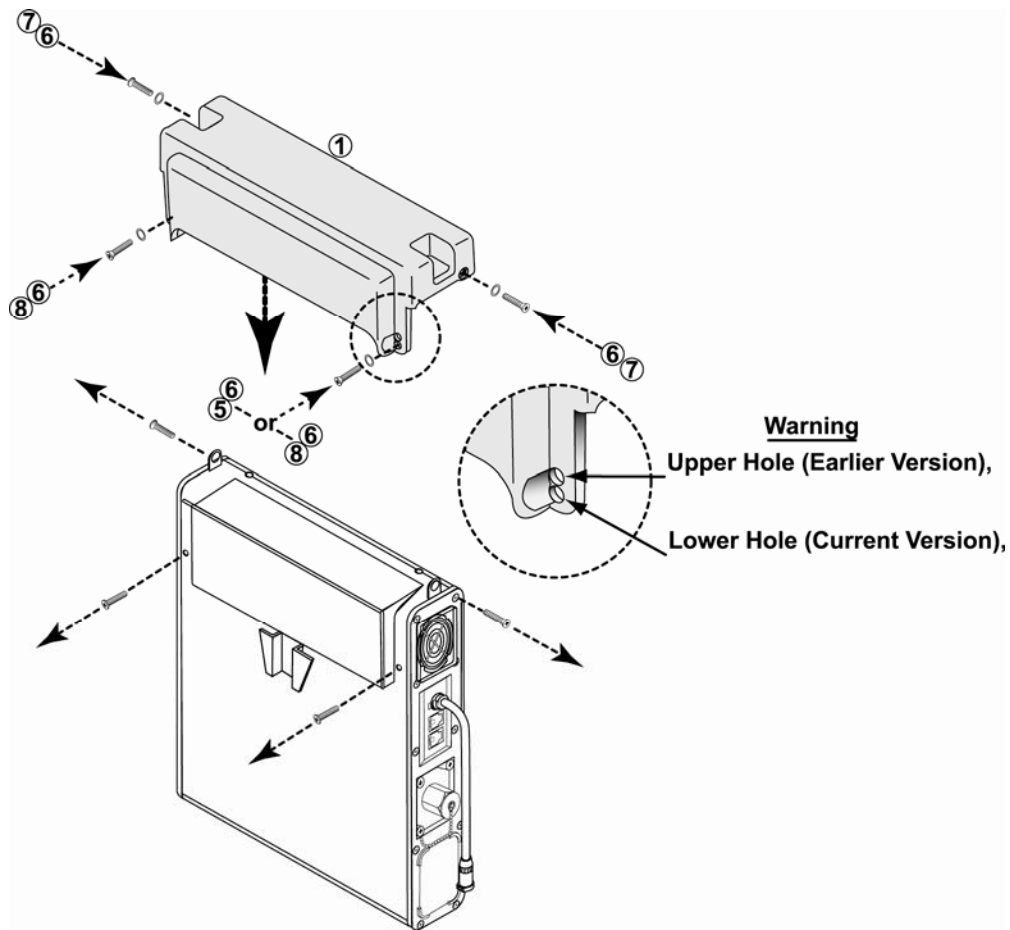

- Item (5), #4-40 X 1/4" Flat-head mounting screw (1) P/N 10430<sup>72</sup>
- Item (6), Finish Washers (8) P/N 10191<sup>72</sup>
- Item (7), #4-40 X 1/2" Flat-head mounting screws (6) P/N 10338<sup>72</sup>
- Item (8), #4-40 X 3/8" Flat-head mounting screws (2) P/N 10474<sup>72</sup>

- 5) Insert and thread two #4-40 X 1/2" flat-head mounting screws (7) with finish washers (6) through the screw holes in the sides of the upper boot, as indicated in the illustration.
- 6) Torque tighten the mounting screws to these specified values (do not over tighten to avoid damage to the finish washers).
  - Torque tighten the screws in the legs of the boot to **60 in-oz** (0.42 Nm)
  - Torque tighten the screws in the sides of the boot to **20 in-oz** (0.14 Nm)

<sup>72</sup> Contained in Pulmonetic Systems Replacement Screws kit, P/N 11149.

### To Install the Lower Protective Boot<sup>73</sup>:

- 1) Lay the ventilator down (front up) and use a Phillips-head screwdriver to remove the four flat-head mounting screws in the ventilator's side panels, as indicated in the illustration.
  - Do not remove the mating finish washers.
- 2) Orient the lower protective boot (2) to the ventilator as shown in the illustration. Move the boot into position on the bottom of the ventilator and align its four screw holes with the corresponding holes in the ventilator side panels.
  - Ensure the orientation arrows on the bottom of the boot are aligned up, as shown.
- 4) Insert and thread four #4-40 X 1/2" flat-head mounting screws (7) with finish washers (6) through the screw holes in the sides of the lower boot; as indicated in the illustration below.
- 5) Torque tighten all four screws in the boot to **20 in-oz** (0.14 Nm) (do not over tighten to avoid damage to the finish washers).

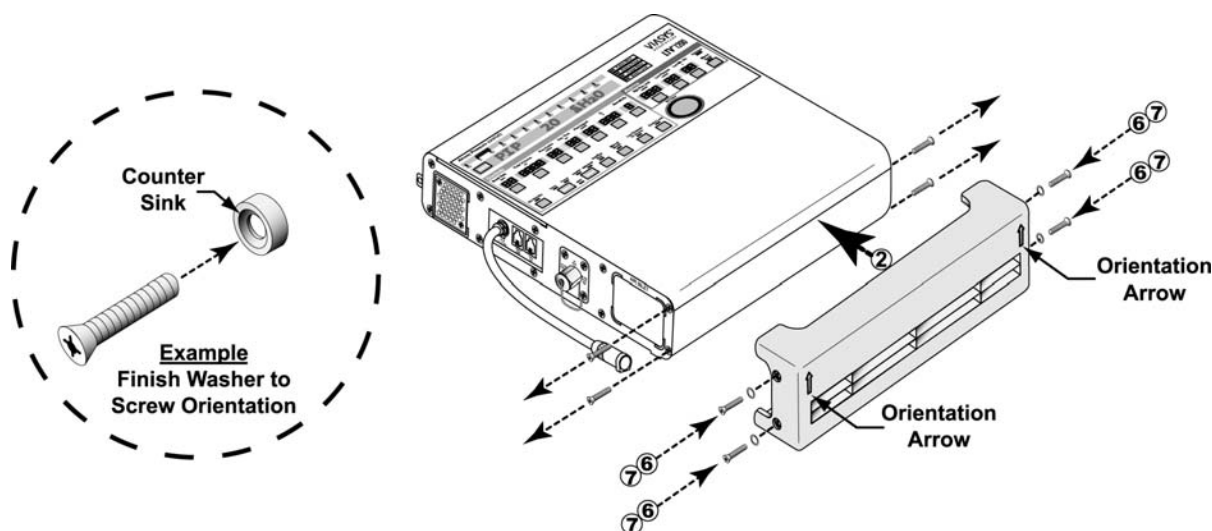

- Item (5), #4-40 X 1/4" Flat-head mounting screw (1) P/N 10430<sup>72</sup>
- Item (6), Finish Washers (8) P/N 10191<sup>72</sup>
- Item (7), #4-40 X 1/2" Flat-head mounting screws (6) P/N 10338<sup>74</sup>
- Item (8), #4-40 X 3/8" Flat-head mounting screws (2) P/N 10474<sup>72</sup>

<sup>73</sup> Refer to page C-9 for information concerning the appropriate accessories mounting screws or accessories replacement screws location, type and length to use when removing or exchanging external accessories on an LTV<sup>®</sup> ventilator.

<sup>74</sup> Contained in Pulmonetic Systems Replacement Screws kit, P/N 11149.

# LTV External Accessories Mounting Screws Location, Type & Length

(Reference Pulmonetic Systems Replacement Screws Kit, P/N 11149)

LTV Ventilator Final Configuration Desired	Screw Location	Qty	Screw Description	Washer Used
Ventilator, with no external accessories installed.	①	3	1/4" Flat-head	None
	②	6	1/4" Flat-head	Finish-washer
	③	2	1/4" Pan-head	None
	④	1	3/16" Pan-head	None
Ventilator, with LTV/LTM Mounting Bracket installed	①	3	3/8" Pan-head	None
	②	6	1/4" Flat-head	Finish-washer
	③	2	3/8" Pan-head	None
	④	1	5/16" Pan-head	None
Ventilator, with Protective Boots installed (Ref. P/N 11509 for installation instructions)	①	3	1/4" Flat-head	None
	②	6	1/2" Flat-head	Finish-washer
	③	2	3/8" Flat-head	Finish-washer
	④	1	1/4" Flat-head	Finish-washer

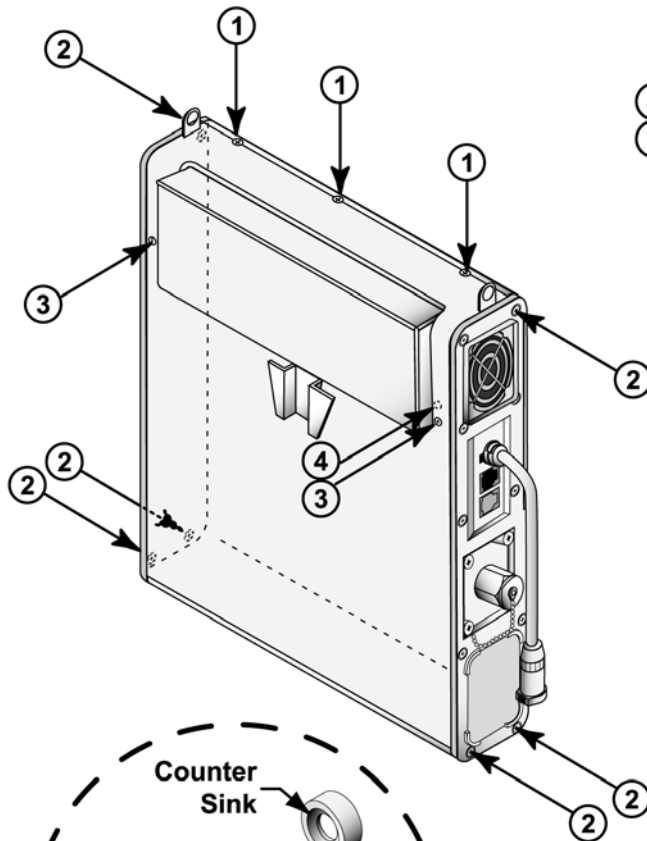

④ - Earlier version LTV ventilator screw location  
 ③ - Current version LTV ventilator screw location

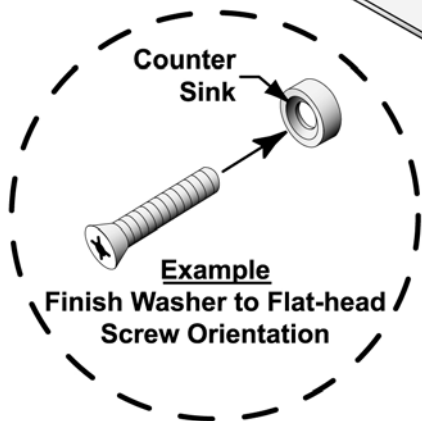
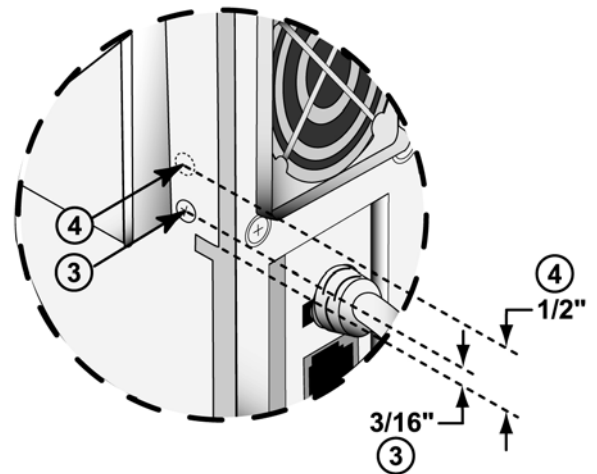

Screw Type/Scale	
Pan-head	Flat-head
3/16"	1/4"
1/4"	3/8"
5/16"	1/2"
3/8"	

(screws shown actual size)

## Patient Breathing Circuit – Connection Instructions

- 1) Connect the main breathing tube to the 22 mm outlet port on the right side of the ventilator.
- 2) Connect the two exhalation flow transducer sense lines to the ports marked **Flow Xducer** on the right side of the ventilator. These are non-interchangeable Luer fittings.
- 3) Connect the exhalation valve drive line to the port marked **Exh Valve** on the right side of the ventilator.

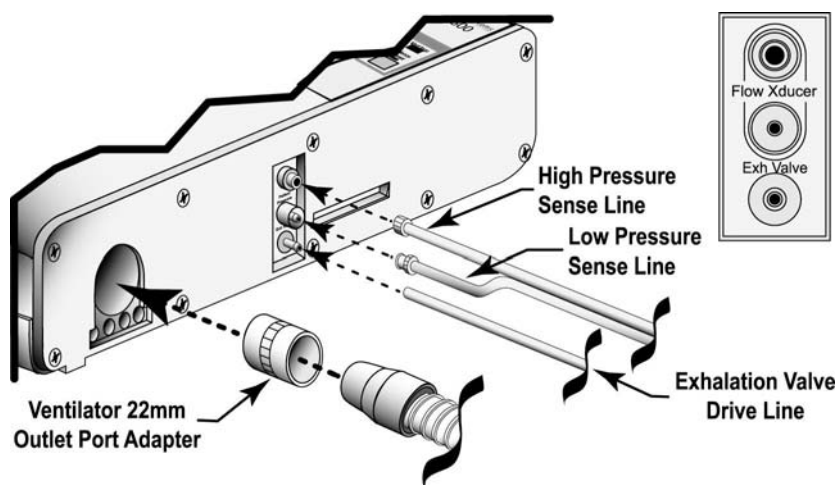

### CAUTION

**Patient Wye Installation** – After cleaning, install the patient wye in the patient circuit so the proximal sense lines are oriented up while operating.

### ATTENTION

**Installation de la soupape d'expiration** - Après le nettoyage, installez la soupape d'expiration dans le circuit du patient de sorte que les lignes de détection soient alignées vers le haut pendant l'opération.

## Ventilator without Humidifier

---

- 1) Connect the main breathing tube to the 22mm outlet port on the right side of the ventilator.

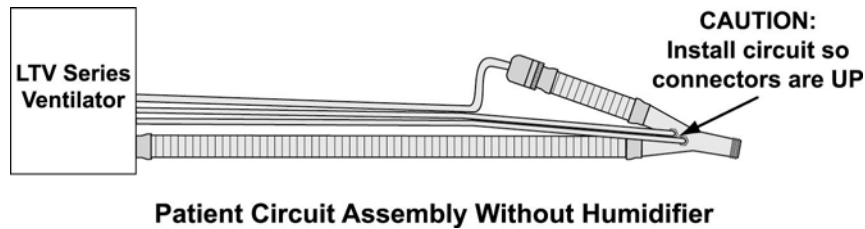

- 2) Connect the two exhalation flow transducer sense lines to the ports marked **Flow Xdcer** on the right side of the ventilator. These are non-interchangeable Luer fittings.
- 3) Connect the exhalation valve drive line to the port marked **Exh Valve** on the right side of the ventilator.

## Ventilator with Humidifier

---

- 1) Attach the main breathing tube to the outlet port on the humidifier.
- 2) Connect the humidifier circuit tube (*not included in reusable circuit configurations*) to the 22mm outlet port on the right side of the ventilator and to the inlet port of the humidifier.

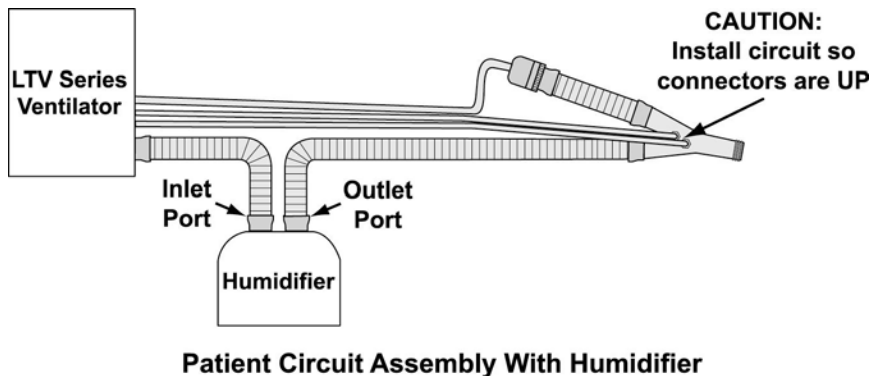

- 3) Connect the two exhalation flow transducer sense lines to the ports marked **Flow Xdcer** on the right side of the ventilator. These are non-interchangeable luer fittings.
- 4) Connect the exhalation valve driveline to the port marked **Exh Valve** on the right side of the ventilator.

## **CAUTION**

**Oxygen Supply Contamination** - The accuracy of the oxygen delivery capabilities of LTV<sup>®</sup> ventilators can be compromised by foreign debris contamination in the oxygen supply system. To reduce the risk of airborne contaminants entering the ventilator, ensure that any oxygen supply connected to the ventilator is clean, properly filtered<sup>75</sup> and that the ventilator's O<sub>2</sub> Inlet Port Cap is securely installed on the O<sub>2</sub> Inlet Port whenever the ventilator is not connected to an external oxygen supply.

## **ATTENTION**

**Contamination de la réserve d'oxygène** — La précision de la capacité d'alimentation en oxygène des ventilateurs LTV<sup>®</sup> peut être compromise par la présence de corps étrangers dans le système d'alimentation en oxygène. Afin de diminuer le risque de présence d'agents contaminants atmosphériques dans le ventilateur, assurez-vous que la réserve d'oxygène reliée au ventilateur est propre et filtrée de manière adéquate<sup>75</sup>, et que le bouchon de l'orifice d'alimentation en oxygène est correctement installé à chaque fois que le ventilateur n'est pas relié à une source d'oxygène externe.

---

<sup>75</sup> In addition to the existing internal O<sub>2</sub> Inlet filter, P/N 14313, an External, In-Line Oxygen Filter (P/N 14470) is available from Pulmonetic Systems, Inc.

### For Operation from a High Pressure Oxygen Source:

To operate from a high pressure (40 - 80 PSIG) oxygen source, connect an oxygen hose to the female DISS<sup>76</sup> oxygen inlet fitting labeled **O2 INLET** on the left side of the ventilator.

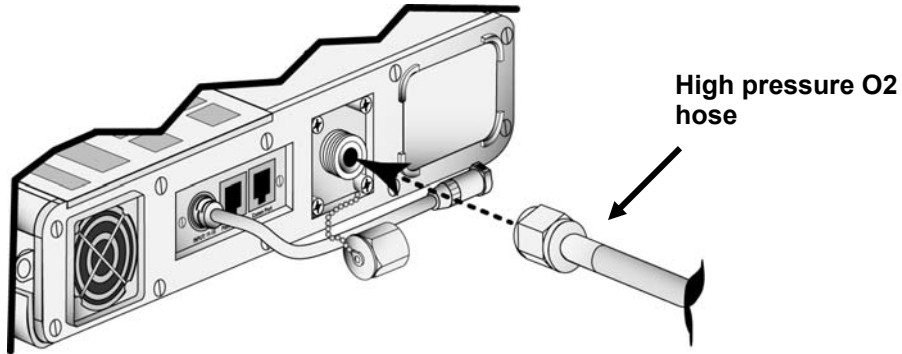

### For Operation from a Low Pressure Oxygen Source:

For operation from a low pressure oxygen source such as an oxygen concentrator, attach the low pressure adapter to the inlet fitting labeled **O2 INLET** located on the left side of the ventilator. Then attach the oxygen supply line to the hose barb on the adapter.

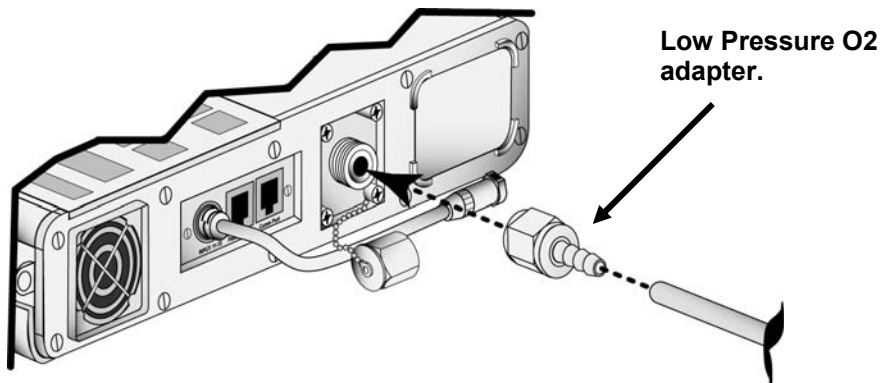

<sup>76</sup> An NIST adapter (P/N 10702) for this connection is available from Pulmonetic Systems upon request.



## *Patient Assist Call System – Connection Instructions*

---

The ventilator is configured to interface with a Patient Assist Call system requiring either normally-closed or normally-open contact sets.

- If your patient assist system is Normally Open, use Patient Assist Cable, Normally Open P/N 10780.
- If your patient assist system is Normally Closed, use Patient Assist Cable, Normally Closed P/N 10779.

### **To connect the ventilator to the patient assist system:**

- 1) Insert the telephone jack connector (RJ11-4) into the port labeled **PATIENT ASSIST** on the left hand side of the ventilator.
- 2) Connect the jack on the other end of the cable to your patient assist system.

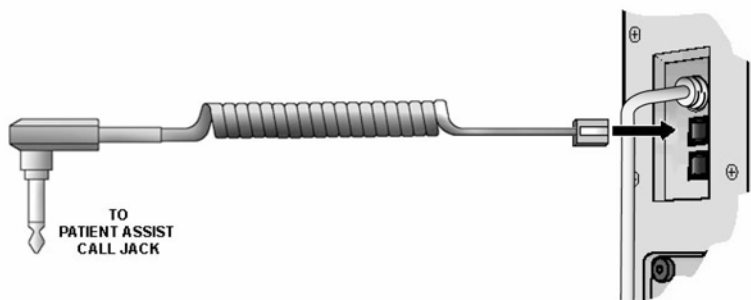

- 3) Test the connection by performing an Alarm test (see *Chapter 11 - Ventilator Checkout Tests*) or by causing an alarm and verifying the patient assist call activates.

### **⚠ WARNING**

**Unapproved Adapters** – Only Pulmonetic Systems Accessories should be used to connect the ventilator to Patient Assist Call Systems. These accessories incorporate safety features to reduce the risk of shock. Do not attempt to modify these accessories in any way.

**Patient Assist Call Connector** – Do not apply more than 25V rms or 32VDC to the Patient Assist Call connector.

### **⚠ AVERTISSEMENT**

**Accessoires non approuvés** – L'utilisation d'accessoires qui ne sont pas expressément approuvés par Pulmonetic Systems pourrait entraîner des conditions dangereuses. Seuls les accessoires de Pulmonetic Systems devraient être utilisés pour brancher les ventilateurs aux systèmes d'aide aux patients. Ces accessoires comportent des caractéristiques de sécurité pour réduire les risques de choc. N'essayez pas de modifier ces accessoires d'aucune façon.

**Connecteur d'appel d'aide aux patients** – Ne mettez pas plus de 25 V efficace ou 32 V c.c. au connecteur d'appel d'aide aux patients.

## Communications Port

---

The Communications Port on the LTV<sup>®</sup> 1200 ventilator allows for attachment to, and communication with, accessories such as graphics monitors or printers. Currently the printer option is only available for use by service personnel.

Use the Communications Setting option in the Extended Features menu to modify the communications protocol (see *Chapter 10 - Extended Features, Communications Setting* for instructions).

## LTM<sup>™</sup> Graphics Monitor

---

The LTM<sup>™</sup> Graphics Monitor is a thin, lightweight color graphics monitor accessory for LTM compatible LTV<sup>®</sup> ventilators.

- For additional information regarding the LTM<sup>™</sup> Graphics Monitor, contact Pulmonetic Systems.

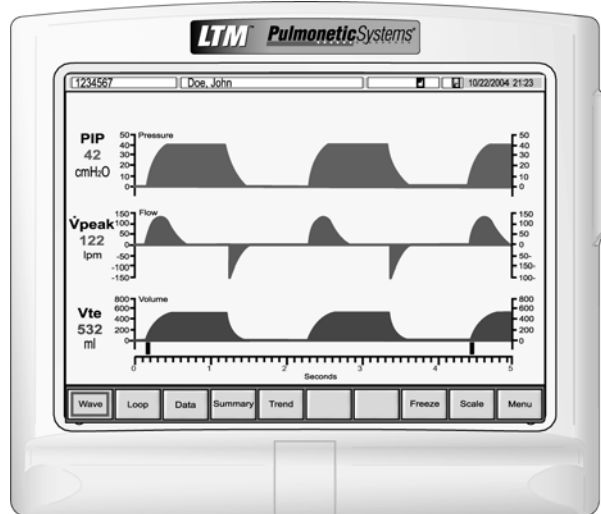

To install and setup an LTM Graphics Monitor, refer to the LTM<sup>™</sup> Graphics Monitor Operator's Manual included with your Monitor.

## Using the Remote Alarm Cable

---

Use the Remote Alarm Cable (P/N 10893) to connect the LTV<sup>®</sup> ventilator to third party, single or dual tone remote alarm systems requiring a normally closed input signal terminated with a 51K ohm series resistor.

- See *Chapter 10 - Extended Features, Alarm Operations*, for instructions on setting the Patient Assist Port output signal for use with single or dual tone remote alarm systems.

Because the ventilator does not include an internal series resistor in the Patient Assist output, a special cable has been designed which incorporates the resistor into the cable assembly itself. The series resistor allows the remote alarm to detect and report both ventilator alarms and a disconnected remote alarm cable.

### CAUTION

**Remote Alarm** - Always verify that the remote alarm properly reports the LTV<sup>®</sup> ventilator alarms before use.

**Remote Alarm** - Always follow the remote alarm manufacturer's usage and maintenance requirements to guarantee proper function of the device.

### ATTENTION

**Alarme à distance** – Assurez-vous toujours que l'alarme à distance indique de façon adéquate les alarmes du ventilateur LTV<sup>®</sup> avant d'utiliser le ventilateur.

**Alarme à distance** – Suivez toujours les exigences d'utilisation et d'entretien du fabricant de l'alarme à distance afin d'assurer le fonctionnement adéquat de l'appareil.

#### To connect the ventilator to the remote alarm:

- 1) Plug the cable's modular jack into the Patient Assist port on the side of the ventilator.
- 2) If the remote alarm has a female BNC plug, connect the cable directly to the remote alarm's input cable or connector and twist to secure.

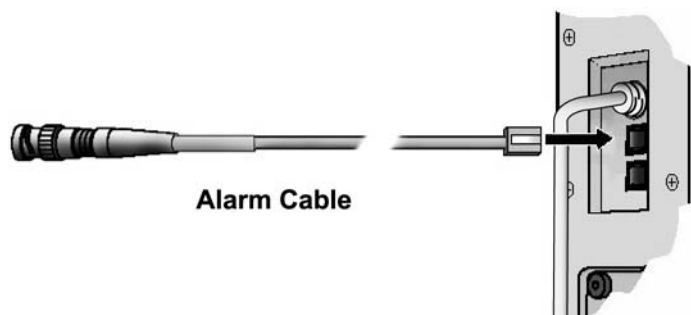

- 3) If the remote alarm has a male BNC plug, insert the included BNC adapter into the cable's connector and twist to secure. Then connect the adapter to the remote alarm's input cable or connector.

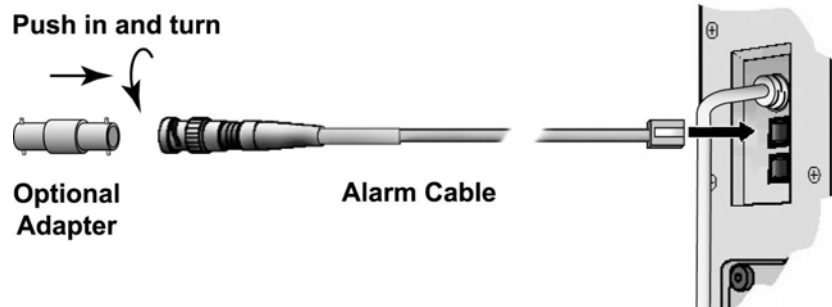

- 4) Create an alarm condition at the ventilator and verify that the remote alarm reflects the alarm state properly.
- 5) Clear the ventilator alarm condition and verify that the remote alarm reflects the alarm state properly.

## Checking the Ventilator for Proper Operation

- 1) Verify that the ventilator is functioning properly by performing the Ventilator Checkout Tests.<sup>77</sup>
  - Disconnect the patient from the ventilator and ventilate the patient using an alternative method before running the Ventilator Checkout tests.
- 2) Connect the AC adapter to a valid AC power source. Connect the patient circuit to the ventilator and to a test lung with a compliance of 10 ml/cmH<sub>2</sub>O and a resistance of 5 cm/L/sec. Do not connect the Oxygen supply. Turn the ventilator on and proceed with the checkout as defined in the following table:

Ventilator Settings and Procedure	Performance Requirement
A) Configure the ventilator settings as follows, and run the equipment for at least two minutes: <b>Mode:</b> Volume, Assist/Ctrl <b>Low Press 02:</b> Off <b>Breath Rate:</b> 12 <b>Tidal Volume:</b> 500 <b>Insp. Time:</b> 1 sec <b>Pressure Support:</b> 0 <b>O<sub>2</sub>%:</b> 21 <b>Sensitivity:</b> 3 <b>High Pressure Limit:</b> 100 <b>Low Pressure Alarm:</b> 5 <b>Low Min Vol:</b> 1.0 <b>PEEP:</b> 0	Selected Monitors should read as follows: <ul style="list-style-type: none"> <li>• Exhaled Tidal Volume: 383 to 633 ml</li> <li>• I:E Ratio : 1:3.8 to 1:4.2</li> <li>• Total Breath Rate: 12 bpm</li> <li>• Total Minute Vol: 4.6 to 7.6 L</li> <li>• No alarms</li> </ul>
B) Set the O <sub>2</sub> % control to 22%	<b>LOW O2 PRES</b> alarm activates after a short pause
C) Reset O <sub>2</sub> % to 21 and clear the alarm. Set the <b>Low Min. Vol.</b> alarm to 10 L	<b>LOW MIN VOL</b> alarm activates
D) Reset the <b>Low Min. Vol.</b> alarm to 1.0 and clear the alarm. Set the Low Pressure alarm to 60.	<b>LOW PRES</b> alarm activates
E) Set the Low Pressure alarm to 5 and clear the alarm. Set the <b>High Pres. Limit</b> to 10 cmH <sub>2</sub> O below the Peak Inspiratory Pressure.	<b>HIGH PRES</b> alarm activates
F) Reset the <b>High Pres. Limit</b> alarm to 100 and clear the alarm.	
G) Connect 40 to 80 PSIG oxygen to the unit and set the O <sub>2</sub> % control to 60. Connect an external oxygen monitor to the patient circuit.	<ul style="list-style-type: none"> <li>• External oxygen monitor should read 55 to 65% O<sub>2</sub></li> <li>• No alarms activate</li> </ul>

<sup>77</sup> See Chapter 11 - Ventilator Checkout Tests for more information

Ventilator Settings and Procedure	Performance Requirement
H) Reset O <sub>2</sub> % control to 21.	
I) Disconnect the high pressure sense line from the ventilator (see the illustration in <i>Appendix C - Patient Breathing Circuit – Connection Instructions</i> )	<ul style="list-style-type: none"> <li>• <b>DISC/SENSE</b> alarm activates on the next breath</li> </ul>
J) Reconnect the high pressure sense line and clear the alarm	
K) Change control settings as follows: <b>Mode:</b> Pressure, Assist/Cntl <b>Pressure Control:</b> 20 <b>PEEP:</b> 20	<p>Selected Monitors should read as follows:</p> <ul style="list-style-type: none"> <li>• PIP: 36 to 44 cmH<sub>2</sub>O</li> <li>• PEEP: 17 to 23 cmH<sub>2</sub>O</li> <li>• No alarms activate</li> </ul>
L) Disconnect AC Adapter from Ventilator at pigtail cable connector	<ul style="list-style-type: none"> <li>• <b>POWER LOST</b> alarm activates</li> <li>• <b>Battery Level</b> LED illuminates showing the charge level</li> <li>• Ventilator continues to operate from the internal battery</li> </ul>

*Ventilator Proper Operation Worksheet*

<b>SERIAL NUMBER:</b> _____	<b>CONDUCTED BY:</b> _____
<b>DATE:</b> _____	

TEST DESCRIPTION	PAGE / STEP	MEAS. VALUE	REQUIREMENT	PASS / FAIL
------------------	-------------	-------------	-------------	-------------

**Ventilator Checkout Tests** (*Chapter 11 -*)

Alarm Test	11-3		Audible alarm must activate for minimum 2 sec's.	
			Confirming audible Chirp must activate after alarm is silenced	
Display Test	11-4		All displays must light except <b>Vent Inop</b>	
Control Test	11-6		Correct messages displayed in window	
Leak Test	11-8		"X.X PASS", Record value displayed	
Vent Inop Alarm Test	11-10		Alarm sounded and Inop LED illuminated 15 sec's.	
			Confirming audible Chirp must activate after alarm is silenced	

**Checking the Ventilator for Proper Operation** (*Appendix C - Installation and Checkout*):

**Ventilator Settings:**

Settings: <b>Mode:</b> Volume, Assist/Ctrl <b>Low Press O<sub>2</sub>:</b> Off <b>Breath Rate:</b> 12 <b>Tidal Volume:</b> 500 <b>Insp. Time:</b> 1 sec <b>O<sub>2</sub>%:</b> 21 <b>Sensitivity:</b> 3 <b>High Pressure Limit:</b> 100 <b>Low Pressure Alarm:</b> 5 <b>Low Min Vol:</b> 1.0 <b>PEEP:</b> 0	C-18 2) A)		Selected Monitors should read as follows:	
			Exhaled Tidal Volume: 383 to 633 ml	
			I:E Ratio : 1:3.8 to 1:4.2	
			Total Breath Rate: 12 bpm	
			Total Minute Vol: 4.6 to 7.6 L	
			No alarms	

**Procedure:**

Set the O <sub>2</sub> % control to 22%	C-18 2) B)		<b>LOW O2 PRES</b> alarm activates after a short pause	
Reset O <sub>2</sub> % to 21 and clear the alarm. Set the <b>Low Min. Vol.</b> alarm to 10 L	C-18 2) C)		<b>LOW MIN VOL</b> alarm activates	
Reset the <b>Low Min. Vol.</b> alarm to 1.0 and clear the alarm. Set the <b>Low Pressure</b> alarm to 60.	C-18 2) D)		<b>LOW PRES</b> alarm activates	
Set the <b>Low Pressure</b> alarm to 5 and clear the alarm. Set the <b>High Pres Limit</b> to 10 cmH <sub>2</sub> O below the Peak Inspiratory Pressure.	C-18 2) E)		<b>HIGH PRES</b> alarm activates.	
Reset the <b>High Pres. Limit</b> alarm to 100 and clear the alarm.	C-18 2) F)			
Connect 40 to 80 PSIG oxygen to the unit, and set the O <sub>2</sub> % control to 60. Connect an external oxygen monitor to the patient circuit.	C-18 2) G)		External oxygen monitor should read 55 to 65% O <sub>2</sub> .	
			No alarms activate.	
Reset O <sub>2</sub> % control to 21.	C-19 2) H)			
Disconnect the high pressure sense line from the ventilator	C-19 2) I)		<b>DISC/SENSE</b> alarm activates on the next breath	
Reconnect the high pressure sense line and clear the alarm	C-19 2) J)			
Change control settings as follows: <b>Mode:</b> Pressure, Assist/Cntl <b>Pressure Control:</b> 20 <b>PEEP:</b> 20	C-19 2) K)		Selected Monitors should read as follows:	
			PIP: 36 to 44 cmH <sub>2</sub> O	
			PEEP: 17 to 23 cmH <sub>2</sub> O	
			No alarms activate	
Disconnect AC Adapter from Ventilator at pigtail cable connector.	C-19 2) L)		<b>POWER LOST</b> alarm activates	
			<b>Battery Level</b> LED illuminates showing the charge level.	
			Ventilator continues to operate from the internal battery	





## Appendix D - PRINCIPLES OF OPERATION

### Overview

The LTV<sup>®</sup> 1200 ventilator utilizes an electromechanical pneumatic system under the control of a microprocessor to deliver patient ventilation. The following diagram and description illustrates the major components of the ventilator and their respective functions.

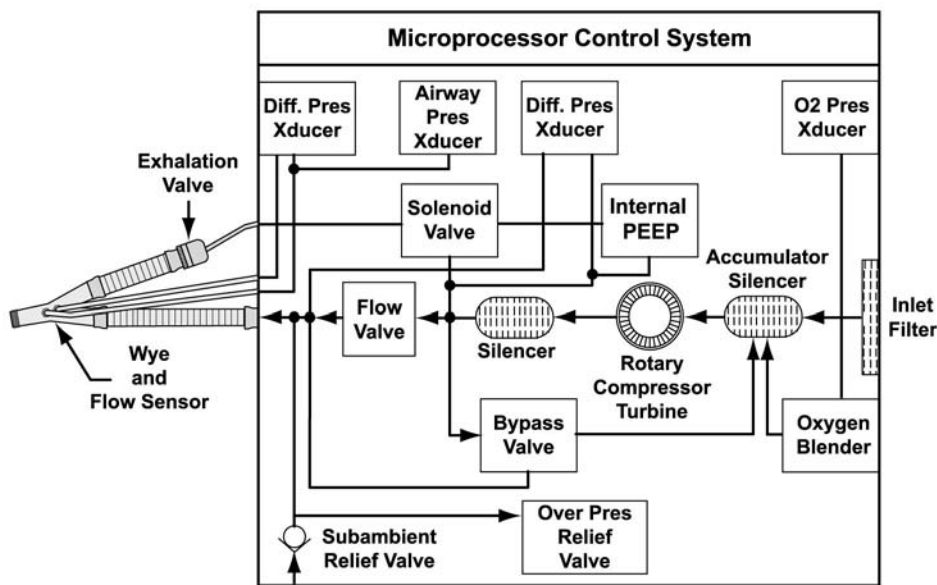

Room air enters the ventilator through a flexible foam **Inlet Filter**. After exiting the filter, the air enters an **Accumulator/Silencer** where it mixes with oxygen delivered from the **Oxygen Blender**. In addition, this chamber provides acoustic silencing to reduce the **Rotary Compressor** input noise. Mixed gas then enters the **Rotary Compressor**, where energy is added to the gas stream as required to meet the pressure and flow delivery requirements of the current ventilation settings.

Gas exiting the **Rotary Compressor** output port enters another **Silencer**. This chamber dampens acoustic noise from the **Rotary Compressor**. Upon exiting the silencing chamber, the gas flow splits in two paths. Gas flow for ventilation diverts to the **Flow Valve**, while excess flow is recirculated through the **Bypass Valve** to the inlet **Accumulator/Silencer**. The **Bypass Valve** maintains **Flow Valve** inlet pressure high enough above **Flow Valve** outlet pressure to ensure a positive differential pressure across the valve, yet low enough to ensure that excess energy is not wasted when operating from batteries.

Ventilation flow enters the **Flow Valve**, which controls all inspiratory gas flow to the patient. The valve is driven by a rotary actuator, and translates circular motion to a poppet position, which in turn meters flow to the patient. The valve is characterized such that gas flow is a known function of differential pressure across the valve and actuator position. A **Differential Pressure Transducer** is provided to measure the differential flow valve pressure.

Ventilation gas exiting the **Flow Valve** is connected to the **Exhalation Valve** by a patient circuit. The **Exhalation Valve** provides the following functions:

- 1) Closes the exhalation port during inspiration to divert gas to the patient.
- 2) Opens the exhalation port during exhalation to allow patient gases to be exhausted to the atmosphere.
- 3) Measures the exhaled flow using a fixed orifice type transducer. Transducer sensor ports are located between the patient and ventilator connection ports.

The **Solenoids (Pilot-in and Pilot-out)** are used to control the pressure in the new pressure accumulator that is used to control the exhalation valve on the patient circuit. The activation of the exhalation circuit controls the PEEP (positive end expiratory pressure) at the patient wye during the expiratory phase.

A **PEEP Transducer** is used to monitor the pilot pressure in the accumulator. This pilot pressure is used in conjunction with the airway pressure transducer by the LTV software to control delivered PEEP.

A **Differential Pressure Transducer** is provided to measure the delta pressure developed across the flow transducer. The transducer is autozeroed to ambient pressure and the sense lines are purged to prevent moisture migration into the transducer.

The **Oxygen Blender** accepts pressurized oxygen from an external source and as directed by the control system meters the oxygen flow to meet the requirements of the current O<sub>2</sub> % setting and ventilation flow demand. The **O<sub>2</sub> Pressure Transducer** measures inlet pressure and is used by the blender control system to compensate the oxygen delivery for variations in oxygen inlet pressure.

The **Sub-Ambient Relief Valve** allows the patient to inspire spontaneously from room air in the event of a failure of the main ventilator system. The **Over Pressure Relief Valve** provides an independent mechanical means to limit the maximum inspiratory pressure. Both of these functions are physically included in the Flow Valve Body.

The **Airway Pressure Transducer** measures pressure at the patient airway and is used for a feedback signal during the delivery of pressure breaths. The transducer is autozeroed to ambient pressure and the sense lines are purged to prevent moisture migration into the transducer.

## Appendix E - EVENT TRACE

The Event Trace is a list of events recorded by the ventilator. These events may be normal conditions, such as turning the ventilator on or off, or alarm conditions such as **HW FAULT** or **HIGH PRES**.

- Initial occurrences of events are recorded the first time they occur after power up, along with the date, time and associated data, if any.
- A second occurrence of the same type of event (same event code) will be recorded as a separate line item along with the latest date, time and associated data. The quantity of occurrences is increased by one (1) (i.e. a quantity of two (2) will be displayed)).
- Additional occurrences (3<sup>rd</sup> or more) of the same type of event will update the secondary occurrence line items with the latest date, time, and associated data. The quantity of occurrences will be increased by one (1) for each additional occurrence (i.e. the quantity of 2 will be increased to 3).

### NOTE

Event log entries are only one of many diagnostic tools used to troubleshoot the ventilator. Additional information is often required to accurately identify the root cause of a problem. See *Chapter 15 - Troubleshooting* for more information.

### REMARQUE

Les entrées du journal d'événements ne représentent que l'un des nombreux outils de diagnostic utilisés pour localiser les pannes du ventilateur. Des informations supplémentaires sont souvent nécessaires pour identifier de façon précise la source d'un problème. Reportez-vous au *Chapitre 15 – Dépannage*, pour de plus amples informations.

#### To view the events:

- 1) Enter the Extended Features menu by pushing and holding the **Select** button for 3 seconds.
- 2) Turn the **Set Value** knob until **EVENT TRACE** is displayed.
- 3) Push the **Select** button while **EVENT TRACE** is displayed.
  - **xx:eventname** is displayed.
  - **xx** is the chronological number of the event occurrence.
  - **eventname** is the name of the event.
- 4) Push the **Select** button.
  - **xx:EyCz** is displayed.
  - **xx** is the chronological number of the event occurrence.
  - **y** is the event code number of the event.
  - **z** is the quantity of occurrences since power up<sup>78</sup>.

---

<sup>78</sup> The maximum number of occurrences recorded is 255.

- 5) Push the **Select** button.
  - **xx:eventdate** is displayed.
  - **xx** is the chronological number of the event occurrence.
  - **eventdate** is the date<sup>79</sup> of the first occurrence.
- 6) Push the **Select** button.
  - **xx:hh:mm:ss** is displayed.
  - **xx** is the chronological number of the event occurrence.
  - **hh:mm:ss** is the time of the first occurrence.
- 7) Push the **Select** button.
  - **xx:data** is displayed.
  - **xx** is the chronological number of the event occurrence.
  - **data** is the data associated with the first occurrence of this event.  
For some events, the data field will be blank.
- 8) Push the **Select** button to return to the initial display.
- 9) Turn the **Set Value** knob clockwise or counterclockwise to view other events.
- 10) To exit the **EVENT TRACE**, turn to **EXIT** and push the **Select** button or push **Control Lock**.

For more information about how these codes are used, see the LTV<sup>®</sup> Series Ventilator's Service Manual (P/N 10665) or contact a certified Pulmonetic Systems' service technician.

---

<sup>79</sup> Date is displayed in the currently selected date format.

## Event Codes

---

This section includes a list of the event codes that can be recorded in the Event Trace.

### Event Codes by Code #

---

Code	Event Name	Event	Associated Alarm
01	VENT 1	Power on	None
02	VENT 0	Power off	None
03	HOUR MTR	Set hour meter	None
04	VENT CHK	Set vent check	Entered VENT CHECK mode
05	APNEA 1	Apnea mode entered	APNEA
06	APNEA 0	Apnea mode exited	APNEA
07		N/A	
08	HIGH DIS	High side disconnect	DISC/SENSE
09	LOW DIS	Low side disconnect	DISC/SENSE
10	DISC 0	Circuit disconnect exited	DISC/SENSE
11	BATMPT1	Internal battery empty occurred	BAT EMPTY
12	BATMPT0	Internal battery empty exited	BAT EMPTY
13	BATLOW1	Internal battery low occurred	BAT LOW
14	BATLOW0	Internal battery low exited	BAT LOW
15	EXT LST1	External power lost occurred	POWER LOST
16	EXT LST0	External power lost exited	POWER LOST
17	EXT LOW1	External power low occurred	POWER LOW
18	EXT LOW0	External power low exited	POWER LOW
19	XDC FLT1	XDCR fault occurred	XDCR FAULT
20	XDC FLT0	XDCR fault exited	XDCR FAULT
21	O2 LOW 1	O <sub>2</sub> pressure low occurred	LOW O2 PRES
22	O2 LOW 0	O <sub>2</sub> pressure low exited	LOW O2 PRES
23	O2 HI 1	O <sub>2</sub> pressure high occurred	HIGH O2 PRES
24	O2 HI 0	O <sub>2</sub> pressure high exited	HIGH O2 PRES
25	DEFAULTS	Defaults, or Set Defaults occurred	DEFAULTS / DEFAULTS SET
26	NO CAL	No calibration data found	NO CAL DATA
27	FAN FLT1	Fan fault occurred	HW FAULT
28	FAN FLT0	Fan fault exited	HW FAULT
29		N/A	
30		N/A	
31	INTRRPT1	Spurious interrupt occurred ms	RESET
32	INTRRPT2	Spurious interrupt occurred ls	RESET
33	AD MMTCH	ADC mismatch	HW FAULT
34	AD MTCH1	ADC mismatch occurred	HW FAULT
35	AD MTCH0	ADC mismatch cleared	HW FAULT
36	SYNCER1	Stepper motor lost sync occurred	HW FAULT

Code	Event Name	Event	Associated Alarm
37	SYNCER0	Stepper motor lost sync exited	HW FAULT
38	HOME ER1	Stepper motor home failure occurred	HW FAULT
39	HOME ER0	Stepper motor home failure exited	HW FAULT
40	EEPROM	EEPROM degraded	HW FAULT
41	CRC	Memory CRC check failed	RESET
42	HI PRES1	High pressure occurred	HIGH PRES
43	HI PRES0	High pressure exited	HIGH PRES
44	TBN ISTOP	Turbine immediate stop occurred	HIGH PRES
45	TBN ZERO	Turbine set to zero flow occurred	HIGH PRES
46	TBN ESTP	Turbine emergency stop occurred	HIGH PRES
47	LOW VE 1	Low minute volume occurred	LOW MIN VOL
48	LOW VE 0	Low minute volume exited	LOW MIN VOL
49	LO PRES1	Low peak pressure occurred	LOW PRES
50	LO PRES0	Low peak pressure exited	LOW PRES
51	CLR EVNT	Event log cleared	N/A
52	CLR CTRL	Control settings cleared	N/A
53	SET DATE	Date set	N/A
54	SET TIME	Time set	N/A
55		N/A	
56	STACK	Stack overflow detected	RESET
57	POST	POST failure	RESET
58	RUNAWAY	Code runaway detected	RESET
59	WDOG TST	Watchdog test run	Inop
60	CLR CAL	Calibration records cleared	N/A
61	XDCR NAR	Differential pressure transducer - Narrow channel fault	XDC FLT1
62	XDCR WID	Differential pressure transducer - Wide channel fault	XDC FLT1
63	XDCR BI	Differential pressure transducer - Bi-directional channel fault	XDC FLT1
64	XDCR AIR	Airway pressure transducer fault	XDC FLT1
65	ADC1 VAL	AD mismatch primary channel fault value	HW FAULT
66	TBN HSTP	Turbine Hold Stop occurred	HIGH PRES
67	LN VENT1	Shutdown for other than pressing <b>On/Standby</b> button	RESET
68	FLUSH ER	A problem is detected writing data to the EEPROM during system shutdown.	HW FAULT
69	RAC ERR1	Problem detected with primary and/or redundant audible alarm circuitry	HW FAULT
70	RAC ERR0	Recovery from problem detected with primary and/or redundant audible alarm circuitry	HW FAULT
71	SNDRERR1	Alarm sounder error	HW FAULT

<b>Code</b>	<b>Event Name</b>	<b>Event</b>	<b>Associated Alarm</b>
72	SNDRERR0	Recovery from alarm sounder error	HW FAULT
73	HIGH f1	High breath rate alarm occurred	HIGH f
74	HIGH f0	High breath rate alarm recovered	HIGH f
75	HI PEEP1	Monitored PEEP	HIGH PEEP
76	HI PEEP0	Monitored PEEP	HIGH PEEP
77	HI SBTf1	Total Breath Rate	SBT > f
78	HI SBTf0	Total Breath Rate	SBT > f
79	LO SBTf1	Total Breath Rate	SBT < f
80	LO SBTf2	Total Breath Rate	SBT < f
81	HI f/Vt1	Rapid Shallow Breathing Index	SBT > f/Vt
82	HI f/Vt0	Rapid Shallow Breathing Index	SBT > f/Vt
83	LO f/Vt1	Rapid Shallow Breathing Index	SBT < f/Vt
84	LO f/Vt0	Rapid Shallow Breathing Index	SBT < f/Vt
85	SBT1	N/A	N/A
86	MON f/Vt	f/Vt value at SBT exit	N/A
87	SBT0	SBT exit reason	N/A
88	CLR BREC	Reclaims all incorrectly recognized bad EEPROM records	N/A
89	LO PEEP1	Monitored PEEP	LOW PEEP
90	LO PEEP0	Monitored PEEP	LOW PEEP
91	NEW PTNT	New patient setup	N/A



## Event Codes by Event Name

Event Name	Code	Event	Associated Alarm
AD MMTCH	33	ADC mismatch	HW FAULT
AD MTCH0	35	ADC mismatch cleared	HW FAULT
AD MTCH1	34	ADC mismatch occurred	HW FAULT
ADC1 VAL	65	AD mismatch primary channel fault value	HW FAULT
APNEA 0	06	Apnea mode exited	APNEA
APNEA 1	05	Apnea mode entered	APNEA
BATLOW0	14	Internal battery low exited	BAT LOW
BATLOW1	13	Internal battery low occurred	BAT LOW
BATMPT0	12	Internal battery empty exited	BAT EMPTY
BATMPT1	11	Internal battery empty occurred	BAT EMPTY
CLR BREC	88	Reclaims all incorrectly recognized bad EEPROM records	N/A
CLR CAL	60	Calibration records cleared	N/A
CLR CTRL	52	Control settings cleared	N/A
CLR EVNT	51	Event log cleared	N/A
CRC	41	Memory CRC check failed	RESET
DEFAULTS	25	Defaults, or Set Defaults occurred	DEFAULTS / DEFAULTS, SET
DISC 0	10	Circuit disconnect exited	DISC/SENSE
EEPROM	40	EEPROM degraded	HW FAULT
EXT LOW0	18	External power low exited	POWER LOW
EXT LOW1	17	External power low occurred	POWER LOW
EXT LST0	16	External power lost exited	POWER LOST
EXT LST1	15	External power lost occurred	POWER LOST
FAN FLT0	28	Fan fault exited	HW FAULT
FAN FLT1	27	Fan fault occurred	HW FAULT
FLUSH ER	68	A problem is detected writing data to the EEPROM during system shutdown.	HW FAULT
HI f/Vt0	82	Rapid Shallow Breathing Index	SBT > f/Vt
HI f/Vt1	81	Rapid Shallow Breathing Index	SBT > f/Vt
HI PEEP0	76	Monitored PEEP	HIGH PEEP
HI PEEP1	75	Monitored PEEP	HIGH PEEP
HI PRES0	43	High pressure exited	HIGH PRES
HI PRES1	42	High pressure occurred	HIGH PRES
HI SBTf0	78	Total Breath Rate	SBT > f
HI SBTf1	77	Total Breath Rate	SBT > f
HIGH DIS	08	High side disconnect	DISC/SENSE
HIGH f0	74	High breath rate alarm recovered	HIGH f
HIGH f1	73	High breath rate alarm occurred	HIGH f
HOME ER0	39	Stepper motor home failure exited	HW FAULT

Event Name	Code	Event	Associated Alarm
HOME ER1	38	Stepper motor home failure occurred	HW FAULT
HOUR MTR	03	Set hour meter	None
INTRRPT1	31	Spurious interrupt occurred ms	RESET
INTRRPT2	32	Spurious interrupt occurred ls	RESET
LN VENT1	67	Shutdown for other than pressing On/Standby	RESET
LO f/Vt0	84	Rapid Shallow Breathing Index	SBT < f/Vt
LO f/Vt1	83	Rapid Shallow Breathing Index	SBT < f/Vt
LO PEEP0	90	Monitored PEEP	LOW PEEP
LO PEEP1	89	Monitored PEEP	LOW PEEP
LO PRES0	50	Low peak pressure exited	LOW PRES
LO PRES1	49	Low peak pressure occurred	LOW PRES
LO SBTf1	79	Total Breath Rate	SBT < f
LO SBTf2	80	Total Breath Rate	SBT < f
LOW DIS	09	Low side disconnect	DISC/SENSE
LOW VE 0	48	Low minute volume exited	LOW MIN VOL
LOW VE 1	47	Low minute volume occurred	LOW MIN VOL
MON f/Vt	86	f/Vt value at SBT exit	N/A
NEW PTNT	91	New patient setup	N/A
NO CAL	26	No calibration data found	NO CAL DATA
O2 HI 0	24	O <sub>2</sub> pressure high exited	HIGH O2 PRES
O2 HI 1	23	O <sub>2</sub> pressure high occurred	HIGH O2 PRES
O2 LOW 0	22	O <sub>2</sub> pressure low exited	LOW O2 PRES
O2 LOW 1	21	O <sub>2</sub> pressure low occurred	LOW O2 PRES
POST	57	POST failure	RESET
RAC ERR0	70	Recovery from problem detected with primary and/or redundant audible alarm circuitry	HW FAULT
RAC ERR1	69	Problem detected with primary and/or redundant audible alarm circuitry	HW FAULT
RUNAWAY	58	Code runaway detected	RESET
SBT0	87	SBT exit reason	N/A
SBT1	85	N/A	N/A
SET DATE	53	Date set	N/A
SET TIME	54	Time set	N/A
SNDRERR0	72	Recovery from alarm sounder error	HW FAULT
SNDRERR1	71	Alarm sounder error	HW FAULT
STACK	56	Stack overflow detected	RESET
SYNC ER1	36	Stepper motor lost sync occurred	HW FAULT
SYNCER0	37	Stepper motor lost sync exited	HW FAULT
TBN ESTP	46	Turbine emergency stop occurred	HIGH PRES
TBN HSTP	66	Turbine Hold Stop occurred	HIGH PRES
TBN ISTP	44	Turbine immediate stop occurred	HIGH PRES
TBN ZERO	45	Turbine set to zero flow occurred	HIGH PRES
VENT 0	02	Power off	None

<b>Event Name</b>	<b>Code</b>	<b>Event</b>	<b>Associated Alarm</b>
VENT 1	01	Power on	None
VENT CHK	04	Set vent check	Entered VENT CHECK mode
WDOG TST	59	Watchdog test run	Inop
XDC FLT0	20	XDCR fault exited	XDCR FAULT
XDC FLT1	19	XDCR fault occurred	XDCR FAULT
XDCR AIR	64	Airway pressure transducer fault	XDC FLT1
XDCR BI	63	Differential pressure transducer - Bi-directional channel fault	XDC FLT1
XDCR NAR	61	Differential pressure transducer - Narrow channel fault	XDC FLT1
XDCR WID	62	Differential pressure transducer - Wide channel fault	XDC FLT1

## Appendix F - GLOSSARY

TERM	DEFINITION
<b>AC</b>	Alternating Current.
<b>Airway circuit</b>	The airway tubing that connects the ventilator and the patient.
<b>Airway pressure</b>	The airway pressure measured at the exhalation valve.
<b>Airway pressure display</b>	A bar graph type display composed of 60 LEDs. This display shows the real-time airway circuit pressure from –10 cmH <sub>2</sub> O to 108 cmH <sub>2</sub> O.
<b>Alarm</b>	An audible and visual announcement that an alarm condition has been met. Audible notification includes an oscillating or continuous tone. Visual notification may include flashing displays, illuminated LEDs, and text messages shown in the display window.
<b>Apnea</b>	Apnea happens when the time between breath starts exceeds the set apnea interval.
<b>Apnea backup ventilation</b>	Apnea Backup Ventilation begins when an apnea alarm occurs and continues until the patient initiates 2 consecutive breaths or the alarm is canceled by an operator. Apnea Backup Ventilation is given in the Assist/Control mode.
<b>Apnea interval</b>	The maximum period of time allowed between breath starts. If the time between breath starts exceeds this interval, an Apnea alarm occurs.
<b>Assist/Control mode</b>	A mode of ventilation where the patient receives a minimum number of machine and assist breaths. The available breath types are Volume Control and Pressure Control.
<b>Assist breath</b>	A volume or pressure breath that the patient triggers, and which is then controlled and cycled by the ventilator. Assist breaths may occur in Assist/Control and SIMV modes.
<b>Autozero</b>	The procedure for determining the transducer zero offset for ambient pressure.
<b>Bias flow</b>	A constant stream of gas through the patient circuit during the exhalation phase of the breath.
<b>bpm</b>	Breaths Per Minute.
<b>Breath period</b>	The time between consecutive ventilator started breaths. The Breath Period is determined by the Breath Rate per minute setting. For instance, a Breath Rate of 6 would give a Breath Period of 10 seconds (60 seconds divided by 6 bpm).
<b>Breath rate, set</b>	The minimum quantity of machine breaths given in a minute.
<b>BTPD</b>	Body Temperature, Pressure Dry.
<b>Circuit</b>	See airway circuit.
<b>Circuit pressure</b>	See airway pressure.
<b>cmH<sub>2</sub>O</b>	Centimeters of water. A unit of measure for pressure.

<b>TERM</b>	<b>DEFINITION</b>
<b>Control mode</b>	A ventilation mode where the ventilator delivers machine breaths at a set rate. In Control Mode, patient triggers are not allowed.
<b>CPAP</b>	Continuous Positive Airway Pressure. The ventilator continuously maintains Positive gas pressure through the patient circuit during the entire breath cycle.
<b>CPAP mode</b>	A ventilation mode where the patient triggers all breaths. Available breath types are Pressure Support and Spontaneous.
<b>Display window</b>	A set of 12 dot-matrix displays used to show monitored data, alarm messages and Extended Feature menu items.
<b>EEPROM</b>	Electrically Erasable Programmable Read Only Memory. Nonvolatile electronic memory that is used by the ventilator to maintain calibration data, control setting and other data when power is not applied to the ventilator.
<b>EPAP</b>	Expiratory Positive Airway Pressure. The positive gas pressure in the patient circuit during breath exhalation.
<b>Event</b>	Any condition noted in the ventilator's event trace. This may include both error conditions and normal operational events.
<b>Exhaled tidal volume</b>	See Tidal Volume.
<b>Expiratory hold</b>	A maneuver which holds the expiratory phase of a delivered breath for a duration sufficient to determine the AutoPEEP of a patient.
<b>Extended features</b>	A set of ventilator controls and options that are not associated with front panel controls. Extended Features are accessed through a menu shown in the display window.
<b>f</b>	See Total Breath Rate, monitored.
<b>Flow</b>	The velocity of gas delivery to the patient, quantified in lpm.
<b>Flow trigger</b>	A patient effort in which the amount of bias flow routed into the patient's lungs exceeds the Sensitivity setting. A flow trigger will result in delivery of an Assist or Patient breath, according to the ventilation mode.
<b>f/Vt</b>	Total Breath Rate divided by the average Exhaled Tidal Volume.
<b>f/Vt f</b>	Total Breath Rate divided by the average Exhaled Tidal Volume, and the Total Breath Rate.
<b>I:E ratio, monitored</b>	The ratio of the inspiration period to the expiration period for a breath. The lesser value is normalized to 1.
<b>I:E ratio, calculated</b>	Calculated Inspiratory:Expiratory ratio, based upon the Inspiratory Time setting and the Breath Rate setting
<b>Inspiratory hold</b>	A maneuver which holds the inspiratory phase of a volume delivered breath for a duration sufficient to determine $\Delta$ Pres pressure and static lung compliance of the patient.
<b>IPAP</b>	Inspiratory Positive Airway Pressure. The positive gas pressure in the patient circuit during breath inhalation.
<b>L</b>	Liters
<b>Leak compensation</b>	Leak Compensation improves triggering when a circuit leak is present.

<b>TERM</b>	<b>DEFINITION</b>
<b>LED</b>	Light Emitting Diode. An indicator that is illuminated on the front panel.
<b>lpm</b>	Liters Per Minute. Flow rate.
<b>Machine breath</b>	A volume or pressure breath that is started by the operator or the ventilator, and is controlled and cycled by the ventilator. Machine Breaths may occur in Control and Assist/Control modes. The operator may cause a machine breath in any mode using the Manual Breath Button.
<b>Manual breath</b>	A Machine Breath initiated by the operator pushing the Manual Breath Button.
<b>MAP</b>	Mean Airway Pressure.
<b>Mean airway pressure, monitored</b>	The average airway pressure over a series of breaths.
<b>Minimum exhalation time</b>	The minimum time required for exhalation is 346 msec. Control settings are limited to ensure the Minimum Exhalation Time is provided. Breaths may not be triggered during the Minimum Exhalation Time.
<b>Minimum inspiratory time</b>	The minimum time required for inspiration is 300 msec. Control settings are limited to ensure the Minimum Inspiratory Time is provided.
<b>Minute volume, monitored (VE)</b>	The total volume exhaled by the patient for the last 60 seconds. VE is refreshed at the conclusion of each breath and is based on the last 8 breaths.
<b>msec</b>	Millisecond: One one-thousandth of a second.
<b>Non-volatile memory</b>	Memory that is retained when ventilator is in Standby mode or powered off.
<b>O<sub>2</sub></b>	Oxygen.
<b>Patient breath</b>	A Pressure Support or Spontaneous breath that is started by the patient, controlled by the ventilator and cycled by the patient. Patient breaths may occur in SIMV and CPAP ventilation modes.
<b>Patient effort</b>	Inspiratory effort by the patient.
<b>Peak inspiratory pressure, monitored (PIP)</b>	The maximum circuit pressure occurring during the inspiration and first 300 ms exhalation phase of a breath. PIP is measured at the patient wye.
<b>PEEP</b>	Positive End Expiratory Pressure.
<b>PIP</b>	Peak Inspiratory Pressure.
<b>Positive end expiratory pressure, monitored (PEEP)</b>	The circuit pressure measured at the end of exhalation.
<b>POST</b>	Power On Self Tests. A set of self-tests the ventilator performs when turned on to verify the operational integrity of the Processor, Displays, Audible alarm, Confirming Audible Chirp, SRAM, Program Memory and EEPROM (some tests require operator visual and/or audible verification).

<b>TERM</b>	<b>DEFINITION</b>
<b>PreSet</b>	A feature allowing ventilator parameters to be “preset” for an infant, pediatric, or an adult patient.
<b>Pressure control breath</b>	A machine or assist breath where the circuit pressure is elevated to a operator-set pressure for a operator-set period of time. Pressure Control breaths have an optional flow termination criteria.
<b>Pressure support breath</b>	A patient breath where the circuit pressure is raised to an operator-set pressure and maintained until flow decreases to an operator-set percentage of the peak flow achieved. Pressure Support Breaths may also be terminated by an operator-set maximum time, or by exceeding 2 breath periods.
<b>PSIG</b>	Pounds per Square Inch Gauge. A unit for measuring pressure.
<b>rpm</b>	Revolutions per minute. Turbine speed is measured in rpm.
<b>Scrolling, monitored data display</b>	Displays the monitored values statically or allows for automatic scrolling. While scrolling is active, each monitored value will be displayed for 3 seconds then the next value will be automatically displayed.
<b>SIMV</b>	Synchronized Intermittent Mandatory Ventilation.
<b>SIMV mode</b>	A ventilation mode where a minimum number of machine or assist breaths are given, and the patient is allowed to trigger additional Patient breaths. Available breath types are volume control, pressure control, pressure support, and spontaneous.
<b>Spontaneous breath</b>	A breath which the patient starts and cycles. Spontaneous breaths are cycled at 10% of peak flow, set variable time termination, or when they exceed 2 breath periods.
<b>Spontaneous Breathing Trial (SBT)</b>	A ventilation mode used to temporarily minimize ventilatory support and perform clinical assessments of a patient’s dependence on, or ability to be removed from positive pressure ventilation.
<b>Tidal volume, monitored (Vte)</b>	The exhaled volume quantified at the patient wye. Exhaled volume is measured for all breath types.
<b>Total breath rate, monitored (f)</b>	The quantity of breaths given per minute; includes all breath types.
<b>Transducer</b>	A measuring device. Transducers can be used to quantify flow or pressure.
<b>Vcalc</b>	A monitor that displays the calculated peak flow for volume control breaths. Vcalc is calculated based on the set tidal volume and the set inspiratory time.
<b>VE</b>	See minute volume, monitored.
<b>Volume control breath</b>	A machine or assist breath where a operator-set volume is delivered over a operator-set time. Flow is delivered in a decelerating waveform where the peak and final flows are calculated so that the final flow is 50% of the peak flow.
<b>Vte</b>	See tidal volume, monitored.

## Appendix G - INDEX

### A

AC Adapter · 14-2  
AC Power Source · 14-2  
Active Alarm · 6-27  
Airway Pressure Display · See Displays:Airway Pressure  
ALARM · 11-3, 15-23  
Alarm Clearing · 6-27  
ALARM OP · 10-3  
Alarm Operations · 10-3  
Alarm Silencing · 6-27  
Alarm Status Messages  
  f PEEP OFF · 9-33  
  H&L PEEP OFF · 9-34  
  HI f/Vt OFF · 9-33  
  HI PEEP OFF · 9-33  
  HIGH f OFF · 9-34  
  LMV LPPS OFF · 9-34  
  LMV OFF · 9-35  
  LO f/Vt OFF · 9-36  
  LO PEEP OFF · 9-35  
  LOCKED · 9-35  
  LPPS OFF · 9-36  
  SBT f OFF · 9-36  
  SBT f/Vt OFF · 9-37  
  SBT HI f OFF · 9-37  
  SBT LO f OFF · 9-37  
  SBT TIME · 9-38  
  WARMUP xx · 9-38  
Alarm Test · 11-3, 15-23  
ALARM VOL · 10-3, 15-23  
Alarm Volume · 10-3, 15-23  
Alarms  
  APNEA · 4-2, 4-3, 9-2, 10-4  
  APNEA xx bpm · 4-2, 4-3, 9-2  
  BAT EMPTY · 9-3  
  BAT LOW · 9-5  
  DEFAULTS · 9-7, 15-20  
  DEFAULTS SET · 9-9  
  DISC/SENSE · 9-10, 15-18, 15-19  
  HIGH f · 9-11  
  HIGH O<sub>2</sub> PRES · 9-12, 15-2  
  HIGH PEEP · 9-13  
  HIGH PEEP · 10-5  
  HIGH PRES · 6-4, 9-14, 10-4, 15-2, 15-17  
  HW FAULT · 9-16, 13-2, 15-19  
  INOP · 9-17  
  LOCKED · 5-6  
  LOW MIN VOL · 6-11, 9-18, 15-2  
  LOW O<sub>2</sub> PRES · 9-19, 15-2  
  LOW PEEP · 9-20  
  LOW PEEP · 10-5

LOW PRES · 6-12, 9-21, 10-4, 15-2  
NO CAL · 8-1, 9-22  
NO CAL DATA · 9-22, 15-19  
POWER LOST · 1-5, 9-23, 14-6  
POWER LOW · 9-24  
REMOVE PTNT · 9-25  
RESET · 9-26, 15-19  
SBT < f · 9-27  
SBT < f/Vt · 9-29  
SBT > f · 9-28  
SBT > f/Vt · 9-30  
SBT OFF · 9-31  
XDCR FAULT · 9-32, 15-19  
Apnea · 4-2, 4-3, 9-2  
Apnea Backup · 4-2, 4-3, 4-5, 9-2  
Apnea Backup Rate · 4-5  
APNEA INT · 10-4  
Apnea Interval · 4-5, 10-4  
APNEA xx bpm · 4-2, 4-3, 9-2  
Assist / Control Mode · 4-1  
Assist/Control/SIMV/CPAP/NPPV Mode · 6-1  
Audible Alarm Test · 11-3  
Audible Alarm Volume · 10-3  
Autocycling · 15-6  
Automatic High O<sub>2</sub> Switch Over · 6-13, 9-12  
Automatic Scrolling · 8-2  
Automobile Cigarette Lighter Adapter · 14-8  
Autozero · 9-32, 10-27

### B

Backup Pressure Trigger · See Triggers  
BAT EMPTY · 9-3  
BAT LOW · 9-5  
Battery · See Internal or External Battery  
Battery Charge Status · 7-4, 14-1  
Battery Level · 7-2  
Bias Flow · 4-6  
Blanked Controls, Displays · 5-4  
Boot, Installation · C-6  
Boot, Removal · C-3  
Boots · C-2  
Breath Type  
  Pressure Control · 3-3  
  Pressure Support · 3-5, 4-4  
  Spontaneous · 3-6  
  Volume Control · 3-2  
Button Controls · 5-3

### C

Calculated Peak Flow · 6-28, 8-2, 8-4  
Calibration · B-1



- Car Lighter Adapter · 14-8
- Cautions · iv
- Charge Status · 7-4, 14-1, 14-11
- Checklist, Ventilator Settings · 12-10
- Checkout Tests · 11-1
- Cigarette Lighter Adapter · 14-8
- Cleaning · 13-1
  - Fan Filter · 13-2
  - Inlet Filter · 13-3
  - O<sub>2</sub> Inlet Filter · 13-4
- Clearing Alarms · See Alarms:Clearing
- Com Port · C-15
- COM SETTING · 10-15
- Communications Port · C-15
- Communications Setting · 10-15, C-15
- Connecting to a Patient · 12-2
- Continuous Flow · See Bias Flow
- CONTROL · 11-6
- Control Lock · 5-6, 6-3, 9-35, 15-3
- Control Mode · 4-1
- Control Test · 11-6
- Control Unlock · 10-14
- Controls · 5-1, 5-2, 5-3, 6-1
  - Assist/Control/SIMV/CPAP/NPPV Mode · 6-1
  - Blank · 5-4
  - Dashes · 5-5
  - Dimmed · 5-4, 15-3
  - Flashing · 5-5
  - High Pressure Limit · 14-5, 15-2
  - Inspiratory Time · 6-10
  - Limiting · 5-5
  - Lock · 5-6, 6-3, 9-35, 10-14, 15-3
  - Low Minute Volume · 6-11, 15-2
  - Low Pressure · 6-12, 15-2
  - Low Pressure O<sub>2</sub> Source · 6-13, 9-12
  - Manual Breath · 6-17
  - O<sub>2</sub>% (O<sub>2</sub> Flush) · 6-14, 6-18, 6-19, 9-19, 15-2, 15-4
  - On/Standby · 6-20
  - PEEP Control · 6-21
  - Pressure Control · 6-22, 15-2
  - Pressure Support · 6-23, 15-2
  - Select · 6-24
  - Sensitivity · 6-25
  - Set Value Knob · 5-3, 6-26
  - Setting · 5-2
  - Silence / Reset · 6-27
  - Tidal Volume · 6-28
  - Unlock · 10-14
  - Volume Pressure Mode · 6-29, 15-4
- CPAP Mode · 4-3
- CRC · 15-19
- CTRL UNLOCK · 10-14, 15-4

---

## D

- Dashes in Display · 5-5
- Date · 10-16, 10-17
- DATE FORMAT · 10-17
- Decelerating Waveform · 3-2, 6-28
- Default Controls Settings · 9-8
- Default Extended Features Settings · 9-8
- DEFAULTS · 9-7, 15-20

- DEFAULTS SET · 9-9
- Dimmed Controls, Displays · 5-4, 15-3
- DISC/SENSE · 9-10, 15-18, 15-19
- Disconnect, Sense Line · 9-10
- DISPLAY · 11-4
- DISPLAY f/Vt · 10-26
- Display Language · 10-14
- Display Select · 11-7, A-1
- Display Test · 11-4
- Display Window · 7-1
- Displays · 5-1, 7-1
  - Airway Pressure · 7-1, 10-18
  - Battery Level · 7-2
  - Blank · 5-4
  - Charge Status · 7-4
  - Dashes · 5-5
  - Dimmed · 5-4, 15-3
  - External Power · 7-5
  - Flashing · 5-5
  - NPPV · 7-6
  - Patient Effort · 7-6
  - Vent Inop · 7-6
  - Window · 7-1

---

## E

- Effort LED · 6-25
- EMC · iii
- EPAP · 4-4, 6-1, 6-21, 12-8
- ET Tube · 15-25
- Event Codes · E-3
- Event Trace · E-1
- Exhaled Minute Volume · 8-3
- Exhaled Tidal Volume · 8-2, 8-3
- EXP HOLD · 6-5, A-1
- Expiratory Hold · 6-5, 6-8, A-1, F-2
- Extended Features · 5-3, 6-24, 6-26
  - Navigation · 10-2
- External Battery · 14-3
  - Disposal · 14-4
- External Power · 7-5, 14-4, 14-9

---

## F

- f · 8-2, 8-3
- f PEEP OFF · 9-33
- f/Vt f · 8-2, 8-4
- Fan Filter · 13-2
- Filter
  - O<sub>2</sub> Inlet · 13-4
- Flashing Controls, Displays · 5-5
- FLOW TERM · 3-4, 3-5, 6-22, 6-23, 10-9, 10-11
- Flow Trigger · See Triggers

---

## H

- H&L PEEP OFF · 9-34
- Help · 2-3, B-2
- HI f/Vt OFF · 9-33
- HI PEEP OFF · 9-33
- HIGH f · 9-11, 10-5, 15-20

HIGH f OFF · 9-34  
HIGH f/Vt · 10-26  
HIGH O2 PRES · 9-12, 15-2  
HIGH PEEP · 9-13, 10-5, 15-20  
HIGH PRES · 6-4, 9-14, 10-4, 15-2, 15-17, 15-18  
High Pressure Alarm Delay · See HP DELAY  
High Pressure Limit · 14-5, 15-2  
High Rate Alarm · See HIGH f  
Hours in Operation · 10-15  
HP DELAY · 10-4, 15-17  
Humidifier · C-11  
HW FAULT · 9-16, 13-2, 15-19

---

## I

IE Ratio · 8-2, 8-3  
Inactive Alarm · 6-27  
Inlet Filter · 13-3  
INOP · 9-17  
INSP HOLD · 6-5, A-1  
Insp/Exp · 6-5, 6-6, 6-8  
Inspiratory Hold · 6-6, A-1, F-2  
Inspiratory Time · 6-10  
Inspiratory/Expiratory · 6-5, 6-6, 6-8, 9-8, A-1  
Internal Battery · 14-11  
    Battery Life · 14-11  
    Charge Status · 14-11  
    Charging · 14-11  
    Disposal · 14-11  
    Replacing · 14-11  
IPAP · 4-4, 6-1, 6-23, 12-8

---

## L

LANGUAGE · 10-14  
LEAK · 11-8  
Leak Compensation · F-2  
Leak Test · 11-8  
Limiting · 5-5, 15-3  
LMV LPPS OFF · 9-34  
LMV OFF · 9-35  
LO f/Vt OFF · 9-36  
LO PEEP OFF · 9-35  
LOCKED · 5-6, 9-35, 15-3  
LOW f/Vt · 10-26  
LOW MIN VOL · 6-11, 9-18, 15-2  
Low Minute Volume · 6-11, 9-18, 15-2  
LOW O2 PRES · 9-19, 15-2  
Low Peak Pressure Alarm · See LPP ALARM, See Low Pressure Alarm  
LOW PEEP · 9-20, 10-5  
LOW PRES · 6-12, 9-21, 10-4, 15-2  
Low Pressure Alarm · 6-12, 10-4, 15-2  
Low Pressure O<sub>2</sub> Source · 6-13, 9-12  
LPP ALARM · 6-12, 10-4  
LPPS OFF · 9-36  
LTM Compatibility · 10-18  
LTM Graphics Monitor · C-15  
LTV1200 · 10-18

---

## M

Maintenance · B-1  
Manometer · See Displays:Airway Pressure  
Manual Breath Button · 6-17  
MAP · 8-2, 8-3  
Mean Airway Pressure · 8-2, 8-3  
Message Window · See Displays:Window  
Minimum Exhalation Time · 3-1  
Minimum Inspiratory Time · 3-1  
Minute Volume · 8-2, 8-3  
MINUTES · 10-26  
Mode Buttons · 5-3  
Model Number · 10-18  
Modes · 4-1  
    Apnea Backup · 4-2, 4-3, 4-5  
    Assist / Control · 4-1  
    Control · 4-1  
    CPAP · 4-3  
    NPPV · 4-4  
    Pressure · 4-6, 6-29  
    SIMV · 4-2  
    Volume · 4-6, 6-29  
Monitor Window · See Displays:Window  
Monitored Data · See Monitors  
Monitored Data Displays · 6-24, 8-2  
Monitors · 6-24  
    Calculated Peak Flow · 8-2, 8-4  
    Exhaled Minute Volume · 8-3  
    Exhaled Tidal Volume · 8-2, 8-3  
    f · 8-3  
    f/Vt f · 8-2, 8-4  
    IE Ratio · 8-2, 8-3  
    MAP · 8-2, 8-3  
    Mean Airway Pressure · 8-2, 8-3  
    Minute Volume · 8-2  
    NO CAL · 9-22, 15-19  
    Peak Inspiratory Pressure · 8-2, 8-3  
    PEEP · 8-2, 8-3  
    PIP · 8-2, 8-3  
    SBT min · 8-2, 8-4  
    Total Breath Rate · 8-2, 8-3  
    Vcalc · 8-2, 8-4  
    VE · 8-2, 8-3  
    Vte · 8-2, 8-3

---

## N

NIST Adapter · C-13  
NO CAL · 8-1, 9-22, 15-19  
NO CAL DATA · 9-22, 15-19  
Non-Invasive Positive Pressure Ventilation · See NPPV mode  
NPPV Mode  
    Indicator · 7-6  
Nurse Call · See Patient Assist Call

---

## O

O<sub>2</sub> Bleed In · 6-16  
O<sub>2</sub> Cylinder Duration · 10-20

O<sub>2</sub> Flush · 10-13  
O<sub>2</sub> Inlet Filter · 13-4  
O<sub>2</sub>% · 15-2  
O<sub>2</sub>% (O<sub>2</sub> Flush) · 6-14, 6-18, 6-19, 9-19, 15-4  
On/Standby Button · 6-20  
Operating Procedures · 12-1  
    Connect to a Patient · 12-2  
Operating Theory · D-1  
Oxygen  
    Blending · 6-18  
    Concentration, Bleed In · 6-16  
    Concentrator · 6-13  
    Connecting · C-13  
    Source · 2-2

---

## P

Patient Assist Call · C-14  
Patient Assist Call System · 15-21  
Patient Circuit  
    Connecting · C-10  
    Humidifier · C-11  
Patient Connection · 12-2  
Patient Effort · 6-25, 7-6  
Patient Query · 10-22  
Patient size · 10-22  
PC FLOW TERM · 3-4, 6-22, 10-9, 10-11, 15-2  
Peak Flow · 6-28  
Peak Inspiratory Pressure · 8-2, 8-3  
PEEP · 10-25  
PEEP Control · 6-21  
PEEP, Monitored · 8-2, 8-3  
PIP · 8-2, 8-3, 10-18  
PIP LED · 10-18  
PNT ASSIST · 10-6, 15-20, 15-21  
Positive End Expiratory Pressure · See PEEP,  
    Monitors:PEEP  
POST · 15-19  
POWER LOST · 1-5, 9-23, 14-6  
POWER LOW · 9-24  
Power Source · 2-2, 14-1  
    AC · 14-2  
    Automobile Cigarette Lighter Adapter · 14-8  
    External Battery · 14-3  
PRES SUPPORT · 10-25  
Presets · 10-22  
Presets Table · 10-23  
Pressure Control · 6-22, 15-2  
Pressure Control Breath · 3-3  
Pressure Control Flow Termination · See PC FLOW  
    TERM  
Pressure Mode · 4-6, 6-29  
Pressure Support · 6-23, 15-2  
Pressure Support Breath · 3-5, 4-4  
Pressure Trigger · See Triggers  
Preventative Maintenance · B-1  
Protective Boot, Installation · C-6  
Protective Boot, Removal · C-3  
Protective Boots · C-2

---

## R

Real Time Transducers · 10-31  
Remote Alarm Cable · C-16  
Remote Alarm System · 15-20  
REMOVE PTNT · 9-25, 11-2  
RESET · 9-26, 15-19  
RISE TIME · 3-3, 6-22, 6-23, 10-8  
Rise Time Profile · See RISE TIME  
RT XDCR DATA · 10-31, 15-6  
RUNAWAY · 15-19

---

## S

SBT < f · 9-27, 15-21  
SBT < f/Vt · 9-29  
SBT > f · 9-28, 15-21  
SBT > f/Vt · 9-30, 15-22  
SBT f OFF · 9-36  
SBT f/Vt OFF · 9-37  
SBT FIO<sub>2</sub> · 10-26  
SBT HI f OFF · 9-37  
SBT HIGH f · 10-26  
SBT LO f OFF · 9-37  
SBT LOW f · 10-26  
SBT min · 8-2, 8-4  
SBT OFF · 9-31  
SBT OP · 10-24  
SBT Operations · 10-24  
SBT Operations, DISPLAY f/Vt · 10-26  
SBT Operations, HIGH f/Vt · 10-26  
SBT Operations, LOW f/Vt · 10-26  
SBT Operations, MINUTES · 10-26  
SBT Operations, PEEP · 10-25  
SBT Operations, PRES SUPPORT · 10-25  
SBT Operations, SBT FIO<sub>2</sub> · 10-26  
SBT Operations, SBT HIGH f · 10-26  
SBT Operations, SBT LOW f · 10-26  
SBT Operations, SBT OP · 10-24  
SBT Operations, SBT START · 10-25  
SBT START · 10-25  
SBT TIME · 9-38  
Scrolled Automatically · 9-33, 9-34, 9-35, 9-36, 9-37, 9-38  
Scrolling · 8-2, F-4  
Select Button · 6-24  
Sensitivity · 6-25  
Serial Number · 10-18  
Service · 2-3, B-2  
SET DATE · 10-16  
Set Defaults · 10-19  
SET TIME · 10-17  
Set Up  
    Assist / Control Mode · 12-5  
    Control Mode · 12-4  
    CPAP Mode · 12-7  
    NPPV Mode · 12-8  
    SIMV Mode · 12-6  
Set Value Knob · 6-26  
Setting a Control · See Controls:Setting  
Settings, Ventilator Checklist · 12-10  
Silence / Reset Button · 6-27

Silence Period · 6-27  
Silencing Alarms · See Alarms:Silencing  
SIMV Mode · 4-2  
Software Version · 10-15  
Specifications · A-1  
Spontaneous Breath · 3-6  
Spontaneous Breathing Trial (SBT) · 10-24  
STACK · 15-19  
Standby · 6-20  
Sterilizing · 13-1

---

## T

Taper Waveform · 3-2, 6-28  
Test  
    Alarm · 15-23  
Tidal Volume · 6-28, 8-3  
Time · 10-17  
TIME TERM · 3-5, 6-23, 10-10, 15-2  
Total Breath Rate · 8-2, 8-3  
Transducer Autozero · 10-27  
Transport Battery System · 14-10  
Triggers · 3-1, 4-6, 6-25, 7-6  
Troubleshooting · 15-1

---

## U

Universal Power Supply kit · 14-10  
Unlock · 10-14, 15-3, 15-4  
Usage Meter · 10-15  
USAGE xxxxx.x · 10-15

---

## V

Valve Home Position · 10-19  
Variable Flow Termination · See FLOW TERM  
Variable Rise Time · See RISE TIME  
Variable Time Termination · See TIME TERM  
Vcalc · 8-2, 8-4

VE · 8-2, 8-3  
VENT CHECK  
    exit · 11-12  
VENT CHECK Menu · 11-1  
Vent Inop · 7-6  
Vent Inop Alarm Test · 11-10  
VENT OP · 10-7  
Vent Operations · 10-7  
Ventilator Checkout · C-18  
Ventilator Checkout Test  
    Alarm Test · 11-3  
    Control Test · 11-6  
    Display Test · 11-4  
    Leak Test · 11-8  
    Vent Inop Alarm Test · 11-10  
Ventilator Checkout Tests · 11-1  
Ventilator Proper Operation Checkout  
    Worksheet · C-20  
VER xx.xx X · 10-15  
VHome · 10-19, 15-7, 15-8, 15-10, 15-12  
Volume Control Breath · 3-2  
Volume Mode · 4-6, 6-29  
Volume Pressure Mode · 6-29, 15-4  
Vte · 8-2, 8-3

---

## W

WARMUP xx · 9-38  
Warnings · iv  
Warranty · ii  
Waveform · 3-2, 6-28  
Worksheets  
    Ventilator Proper Operation Checkout · C-20

---

## X

XDCR FAULT · 9-32, 15-19  
XDCR ZERO · 10-27, 15-7, 15-8, 15-9, 15-10, 15-11, 15-13